

KOHLERengines

***SERVICE MANUAL
COMMAND 5, 6 HP***

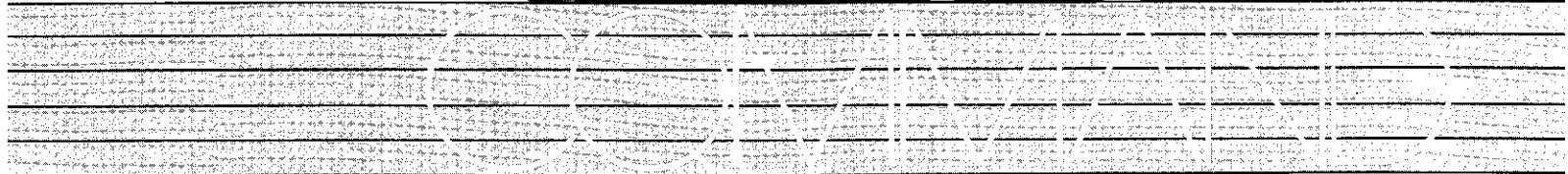
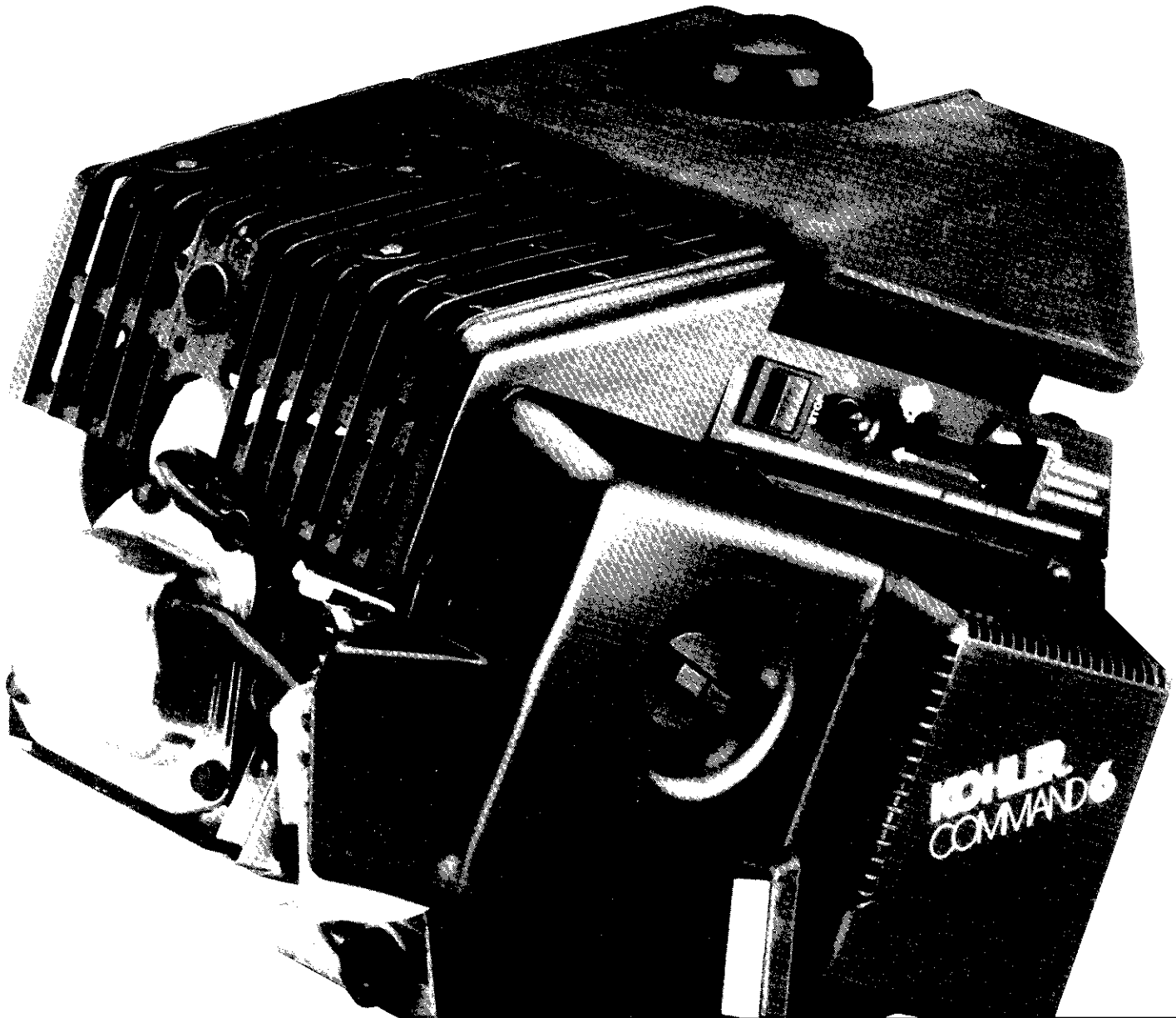

CONTENTS

SECTION 1. Safety And General Information	1
SECTION 2. Special Tools	2
SECTION 3. Troubleshooting	3
SECTION 4A. (CH5) Air Cleaner And Intake System	4
SECTION 4B. (CH6) Air Cleaner And Intake System	4
SECTION 5. Fuel System And Governors	5
SECTION 6. Lubrication System	6
SECTION 7. Retractable Starter	7
SECTION 8. Electrical System And Components	8
SECTION 9. Disassembly	9
SECTION 10. Internal Components	10
SECTION 11. Reassembly	11

SECTION 1

SAFETY AND GENERAL INFORMATION

SAFETY INFORMATION

For Your Safety!

These precautions should be followed at all times. Failure to follow these precautions could result in injury to yourself and others nearby.

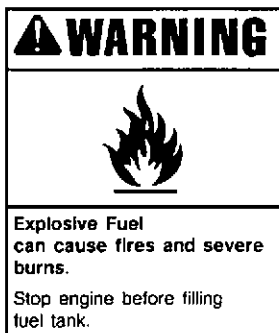

Explosive Fuel!

Gasoline is extremely flammable and its vapors can explode if ignited. Store gasoline only in approved containers, in well-ventilated, unoccupied buildings, away from sparks or flames. Do not fill the fuel tank while the engine is hot or running, since spilled fuel could ignite if it comes in contact with hot parts or sparks from ignition. Do not start the engine near spilled fuel. Never use gasoline as a cleaning agent.

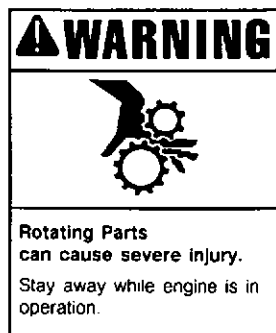

Rotating Parts!

Keep hands, feet, hair, and clothing away from all moving parts to prevent injury. Never operate the engine with covers, shrouds, or guards removed.



Hot Parts!

Engine components can get extremely hot from operation. To prevent severe burns, do not touch these areas while the engine is running – or immediately after it is turned off. Never operate the engine with heat shields or guards removed.

SECTION 1

SAFETY AND GENERAL INFORMATION



Accidental Starts!

Before servicing the engine or equipment, always disconnect the spark plug lead to prevent the engine from starting accidentally. Ground the lead to prevent sparks that could cause fires. Make sure the equipment is in neutral.



CAUTION: Electrical Shock!

Never touch electrical wires or components while the engine is running. They can be sources of electrical shock.



WARNING: Overspeed Is Hazardous!

Do not tamper with the governor setting. Overspeed is hazardous and could cause personal injury.



WARNING: Flammable Solvents!

Carburetor cleaners and solvents are extremely flammable. Keep sparks, flames, and other sources of ignition away from the area. Follow the cleaner manufacturer's warnings and instructions on its proper and safe use. Never use gasoline as a cleaning agent.

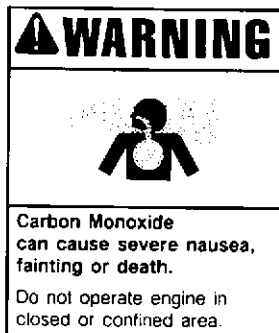

Lethal Exhaust Gases!

Engine exhaust gases contain poisonous carbon monoxide. Carbon monoxide is odorless, colorless, and can cause death if inhaled. Avoid inhaling exhaust fumes, and never run the engine in a closed building or confined area.



WARNING: Spring Under Tension!

Retractable starters contain a powerful, flat wire recoil spring that is under tension. Do not remove the center screw from the starter until the spring tension is released. Removing the center screw before releasing spring tension, or improper starter disassembly, can cause the sudden and potentially dangerous release of the spring.

Always wear safety goggles when servicing retractable starters – full face protection is recommended.

To ensure personal safety and proper starter disassembly and reassembly, follow the procedures in this section carefully.

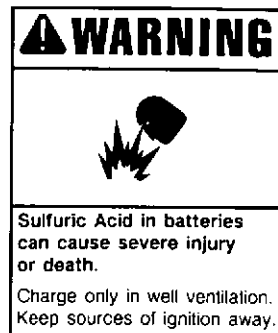

Dangerous Acid, Explosive Gases!

Batteries contain sulfuric acid. To prevent acid burns, avoid contact with skin, eyes, and clothing. Batteries produce explosive hydrogen gas while being charged. To prevent a fire or explosion, charge batteries only in well ventilated areas. Keep sparks, open flames, and other sources of ignition away from the battery at all times. Keep batteries out of the reach of children. Remove all jewelry when servicing batteries.

Before disconnecting the negative (-) ground cable, make sure all switches are OFF. If ON, a spark will occur at the ground cable terminal which could cause an explosion if hydrogen gas or gasoline vapors are present.

ENGINE IDENTIFICATION NUMBERS

When ordering parts, or in any communication involving an engine, always give the **Model, Specification, and Serial Numbers** of the engine. Include letter suffixes, if there are any.

The engine identification numbers appear on decal (or decals) affixed to the engine shrouding. See Figure 1-1. The significance of these numbers is shown in Figure 1-2.

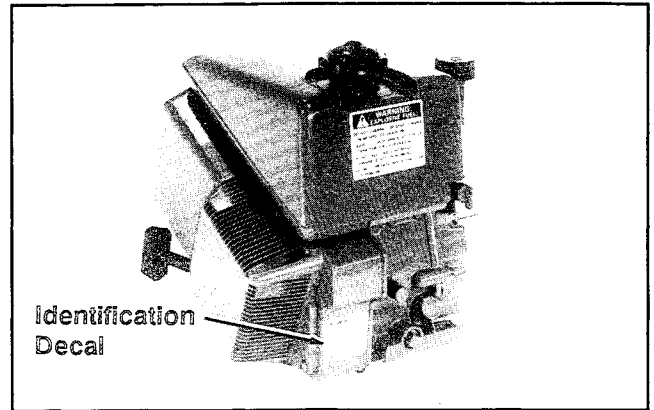

Figure 1-1. Engine Identification Plate Location.

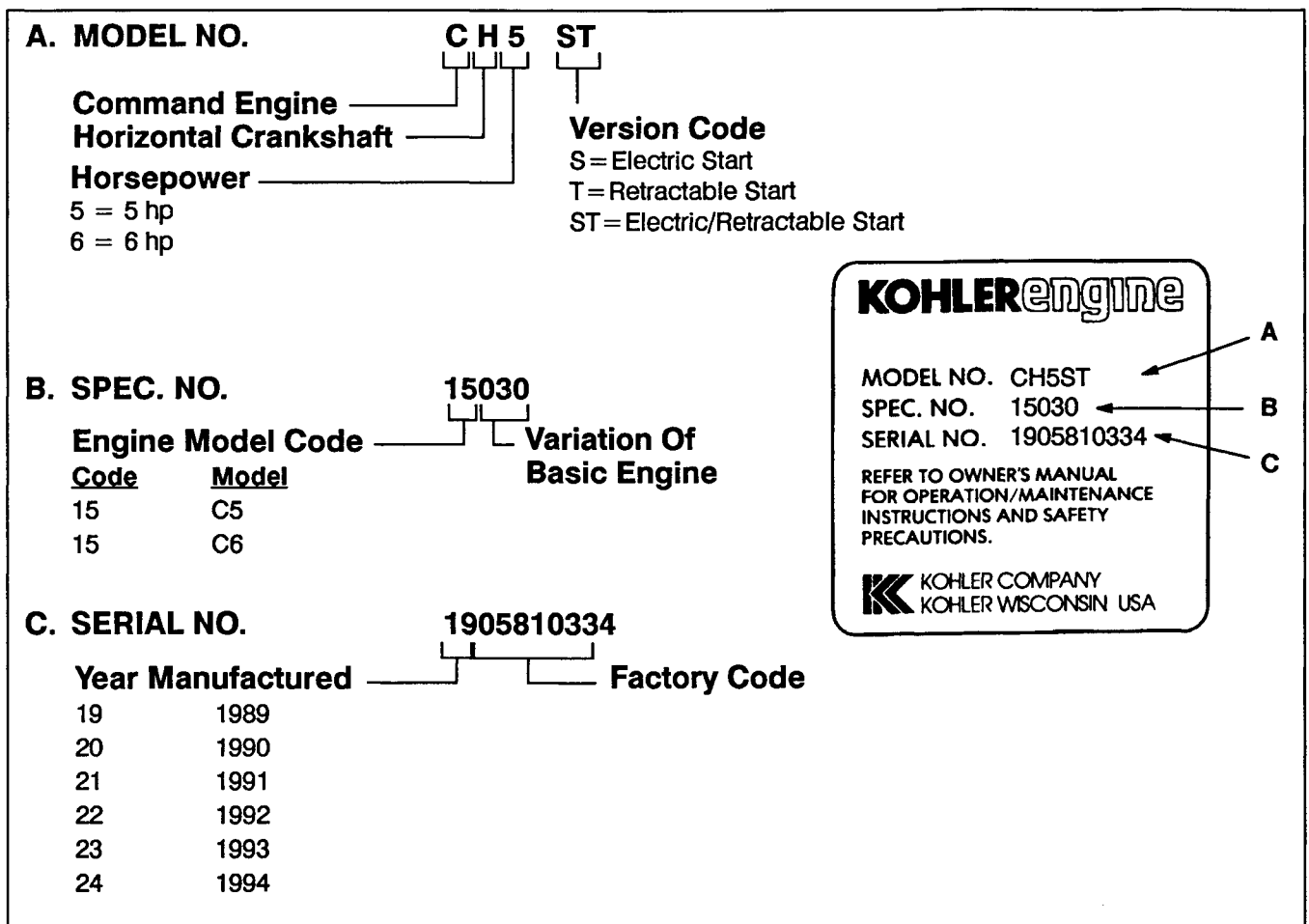

Figure 1-2. Significance Of Engine Identification Numbers.

SECTION 1

SAFETY AND GENERAL INFORMATION

OIL RECOMMENDATIONS

Using the proper type and weight of oil in the crankcase is extremely important. So is checking oil daily and changing oil regularly. Failure to use the correct oil, or using dirty oil, causes premature engine wear and failure.

Oil Type

Use high-quality detergent oil of API (American Petroleum Institute) service class SF or SG. Select the viscosity based on the air temperature at the time of operation as shown in the following table.

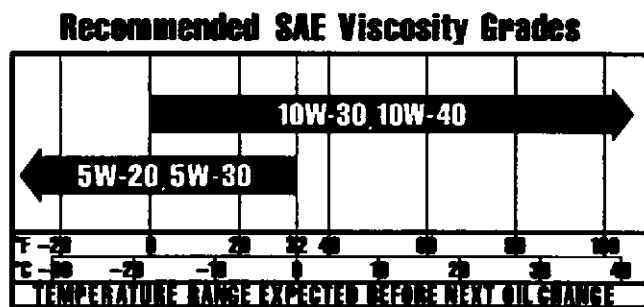

NOTE: Using other than service class SF or SG oil or extending oil change intervals longer than recommended can cause engine damage.

A logo or symbol on oil containers identifies the API service class and SAE viscosity grade. See Figure 1-3.

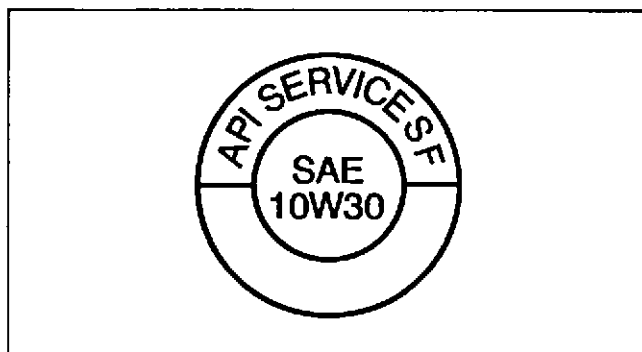

Figure 1-3. Oil Container Logo.

Refer to Section 6 — “Lubrication System” for detailed oil check and oil change procedures.

FUEL RECOMMENDATIONS



WARNING: Explosive Fuel!

Gasoline is extremely flammable and its vapors can explode if ignited. Store gasoline only in approved containers, in well-ventilated, unoccupied buildings, away from sparks or flames. Do not fill the fuel tank while the engine is hot or running, since spilled fuel could ignite if it comes in contact with hot parts or sparks from ignition. Do not start the engine near spilled fuel. Never use gasoline as a cleaning agent.

General Recommendations

Purchase gasoline in small quantities and store in clean, approved containers. A container with a capacity of 2 gallons or less with a spout is recommended. Such a container is easier to handle and helps eliminate spillage during refueling.

Do not use gasoline left over from the previous season to minimize gum deposits in your fuel system and to insure easy starting.

Do not add oil to the gasoline.

Do not overfill the fuel tank—leave room for the fuel to expand.

Fuel Type

For best results use only clean, fresh, **unleaded** gasoline with a pump sticker octane rating of 87 or higher. In countries using the Research method, it should be 90 octane minimum.

Unleaded gasoline is recommended as it leaves less combustion chamber deposits. Leaded gasoline may be used in areas where unleaded is not available and exhaust emissions are not regulated. Be aware however, that the cylinder head will require more frequent service.

Gasoline/Alcohol blends

Gasohol (up to 10% ethyl alcohol, 90% unleaded gasoline by volume) is approved as a fuel for Kohler engines. Other gasoline/alcohol blends are not approved.

Gasoline/Ether blends

Methyl Tertiary Butyl Ether (MTBE) and unleaded gasoline blends (up to maximum of 15% MTBE by volume) are approved as a fuel for Kohler engines. Other gasoline/ether blends are not approved.

PERIODIC MAINTENANCE



WARNING: Accidental Starts!

Before servicing the engine or equipment, always disconnect the spark plug lead to prevent the engine from starting accidentally. Ground the lead to prevent sparks that could cause fires.

Maintenance Schedule

These required maintenance procedures should be performed at the frequency stated in the table. They should also be included as part of any seasonal tune-up.

FREQUENCY	MAINTENANCE REQUIRED	REFER TO:
Daily Or Before Starting Engine	Fill fuel tank. Check oil level. Check air cleaner for dirty ¹ , loose, or damaged parts. Check air intake and cooling areas, clean as necessary ¹ .	SECTION 5 SECTION 6 SECTION 4 SECTION 4
Every 25 Hours	Service precleaner element ¹ .	SECTION 4
Every 100 Hours	Service air cleaner element ¹ . Change oil. Check spark plug condition and gap. Remove cooling shrouds and clean cooling areas ¹ .	SECTION 4 SECTION 6 SECTION 8 SECTION 4
Annually Or Every 500 Hours	Service starter motor drive, if equipped. Check optional Oil Sentry™ float switch	SECTION 8 SECTION 8

¹ Perform these maintenance procedures more frequently under extremely dusty, dirty conditions.

STORAGE

If the engine will be out of service for two months or more, use the following storage procedure:

1. Change the oil while the engine is still warm from operation. See "Change Oil" in Section 6.
2. The fuel system must be completely emptied, or the gasoline must be treated with a stabilizer to prevent deterioration. If you choose to use a stabilizer, follow the manufacturers recommendations, and add the correct amount for the capacity of the fuel system. Fill the fuel tank with clean, fresh gasoline. Run the engine for 2-3 minutes to get stabilized fuel into the carburetor.

To empty the system, drain the fuel tank and carburetor, or run the engine until the tank and system are empty.

3. Remove the spark plug. Add one tablespoon of engine oil into the spark plug hole. Install the plug, but do not connect the plug lead. Crank the engine two or three revolutions.
4. Remove the spark plug and rotate the crankshaft until the piston is at the top of its stroke. Reinstall the plug, but do not connect the plug lead.
5. Clean the exterior surfaces of the engine.
6. Store the engine in a clean, dry place.

SECTION 1 SAFETY AND GENERAL INFORMATION

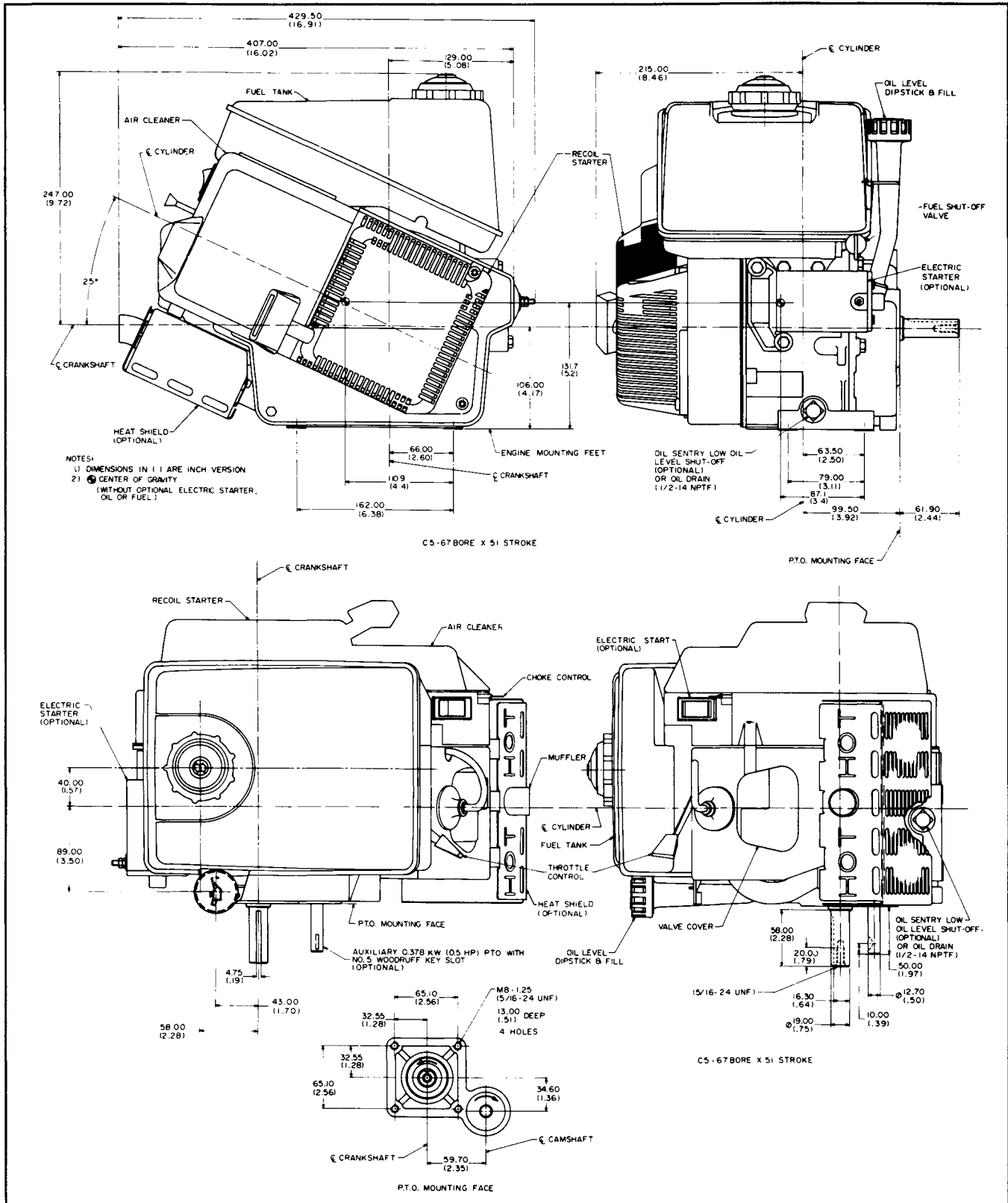

Figure 1-4. Typical CH5 Engine Dimensions.

SECTION 1 SAFETY AND GENERAL INFORMATION

1

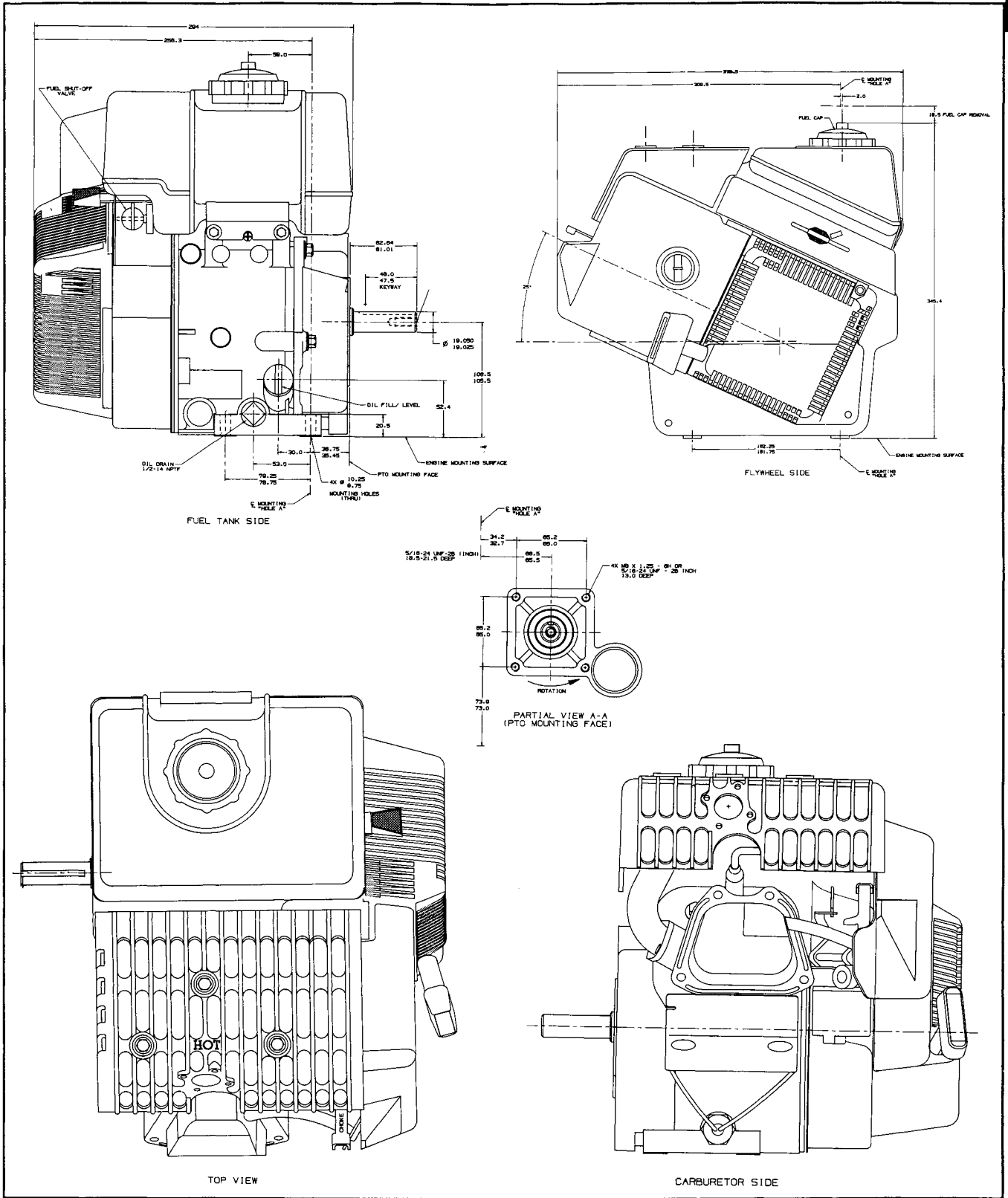

Figure 1-5. Typical CH6 Engine Dimensions.

SECTION 1 SAFETY AND GENERAL INFORMATION

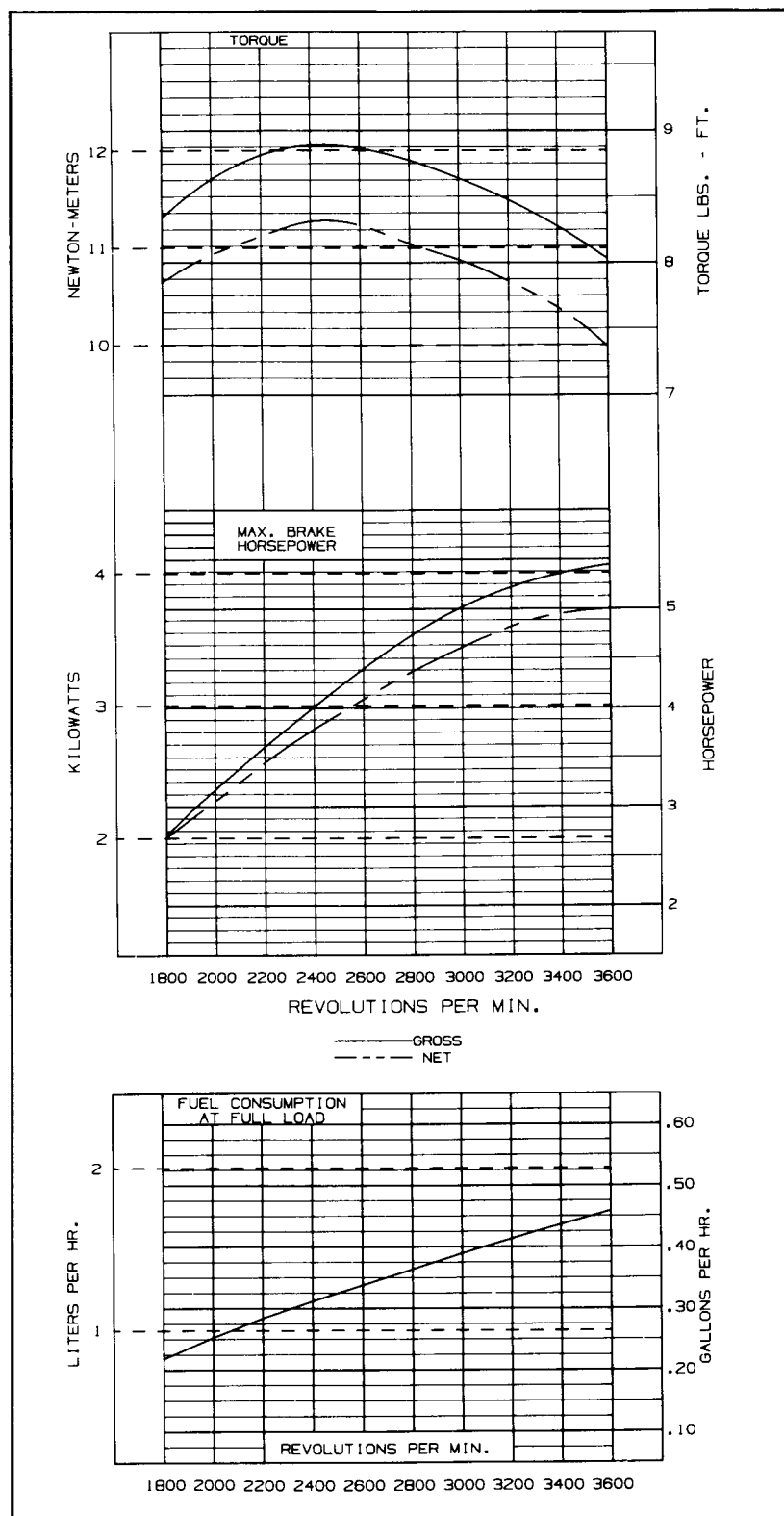

Figure 1-6. CH5 Power, Torque, And Fuel Data.

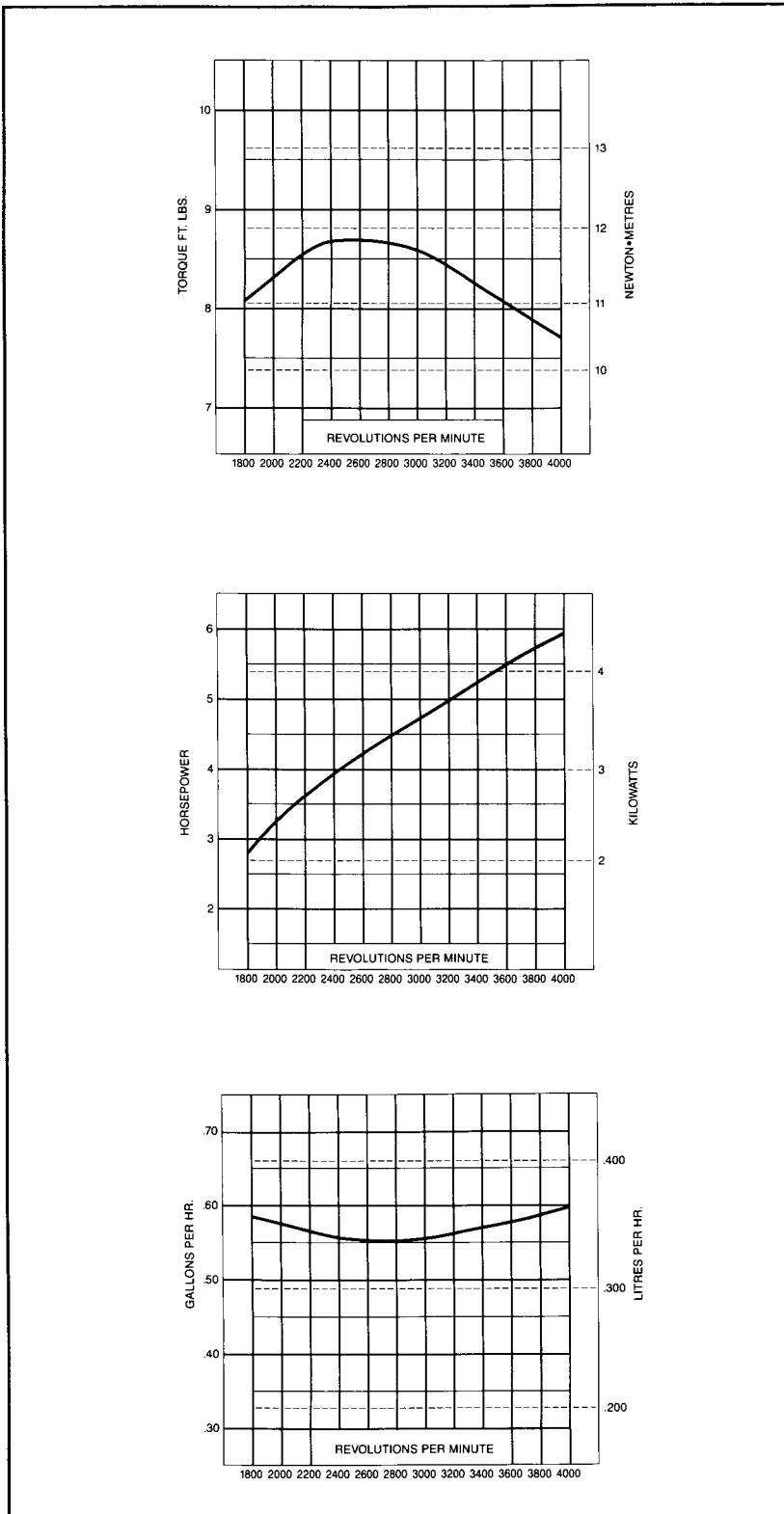

Figure 1-7. CH6 Power, Torque, And Fuel Data.

SECTION 1

SAFETY AND GENERAL INFORMATION

SPECIFICATIONS, TOLERANCES, AND SPECIAL TORQUE VALUES¹

DESCRIPTION	CH5 & CH6
-------------	-----------

General Specifications

Power (@ 3600 rpm, corrected to SAE J1349) CH5	3.73 kW (5 hp)
Power (@ 4000 rpm, corrected to SAE J1349) CH6	4.47 kW (6 hp)
Peak Torque (@ 2200 rpm) CH5	11.4 N•m (8.4 ft. lb.)
Peak Torque (@ 2600 rpm) CH6	11.6 N•m (8.6 ft. lb.)
Bore	67 mm (2.64 in.)
Stroke	51 mm (2.01 in.)
Displacement	180 cu. cm (10.98 cu. in.)
Compression Ratio	8.5 : 1
Weight (Approx.)	16.33 kg (36 lb.)
Oil Capacity (Approx.)	0.66 liter (0.7 U.S. qt.)
Fuel Tank Capacity (Approx.) CH5	3.78 liter (4.0 U.S. qt.)
Fuel Tank Capacity (Approx.) CH6	2.84 liter (3.0 U.S. qt.)

Air Cleaner

Base Nut Torque	6.8 N•m (58 in. lb.)
-----------------------	----------------------

Angle Of Operation – Maximum (At Full Oil Level)

Intermittent – All Directions	35°
Continuous – All Directions	20°

Camshaft

End Play	0.15–0.55 mm (0.0059–0.0217 in.)
Bore I.D. – Max. Wear Limit	
Crankcase	16.030 mm (0.6311 in.)
Closure Plate	25.430 mm (1.0012 in.)
Camshaft Bearing Surface O.D. – Max. Wear Limit	
Crankcase End	15.954 mm (0.6281 in.)
Closure Plate End	25.350 mm (0.9980 in.)

Carburetor

Preliminary Low Idle Fuel Needle Setting	1 Turn
Preliminary High Speed Setting (Adjustable Main Jet Type)	1-1/8 Turn
Fuel Bowl Retaining Screw Torque	9.8 N•m (87 in. lb.)
Throttle Plate Retaining Screw Torque	0.9 – 1.4 N•m (8 – 12 in. lb.)

Charging

Stator Air Gap	0.203 – 0.305 mm (0.008 – 0.012 in.)
Stator Mounting Screw Torque	4.0 N•m (35 in. lb.)

Closure Plate

Closure Plate Fastener Torque	22.6 N•m (200 in. lb.)
-------------------------------------	------------------------

Connecting Rod

Connecting Rod Cap Fastener Torque	9.0 N•m (80 in. lb.)
Connecting Rod-To-Crankpin Running Clearance	
New	0.030 – 0.056 mm (0.0012 – 0.0022 in.)
Max. Wear Limit	0.0635 mm (0.0025 in.)
Connecting Rod-To-Crankpin Side Clearance	0.431 – 0.661 mm (0.0170 – 0.0260 in.)
Connecting Rod-To-Piston Pin Running Clearance	0.015 – 0.003 mm (0.0006 – 0.0011 in.)
Piston Pin End I.D.	
New	14.015 – 14.023 mm (0.5518 – 0.5521 in.)
Max. Wear Limit	14.036 mm (0.5526 in.)

Crankshaft

End Play (Free)	0.000 – 0.056 mm (0.0000 – 0.0022 in.)
Crankshaft Bore to Crankshaft (CH6 with Sleeve Bearings)*	
Running Clearance – New	0.02–0.09 mm (0.0008–0.0036 in.)
Running Clearance – Max. Wear Limit	0.115 mm (0.0046 in.)
Crankshaft Flywheel End Main Bearing (CH6 with Sleeve Bearings)*	
Outside Diameter – New	30.000 – 30.008 (1.20–1.2003 in.)
O.D. Maximum Wear Limit	29.95 mm (1.198 in.)
Taper – Maximum	0.020 mm (0.0008 in.)

SECTION 1

SAFETY AND GENERAL INFORMATION

Out-of-Round – Maximum 0.025 mm (0.0010 in.)

Crankshaft Closure Plate End Main Bearing (CH6 with Sleeve Bearings)*

Outside Diameter – New 29.971–29.980 mm (1.1988–1.1992 in.)

O.D. Maximum Wear Limit 29.93 mm (1.1972 in.)

Taper – Maximum 0.020 mm (0.0008 in.)

Out-of-Round – Maximum 0.025 mm (0.0010 in.)

Connecting Rod Journal

O.D. – New 30.947–30.960 mm (1.2184–1.2189 in.)

O.D. – Max. Wear Limit 30.934 mm (1.2179 in.)

Max. Taper 0.025 mm (0.0010 in.)

Max. Out-Of-Round 0.013 mm (0.0005 in.)

Crankshaft T.I.R. – PTO End 0.10 mm (0.004 in.)

*Sleeve bearings standard spec. on CH6 – ball bearings optional specs.

Cylinder Bore

Cylinder Bore I.D. – New 67.000–67.030 mm (2.6378–2.6390 in.)

Cylinder Bore I.D. – Max. Wear Limit 67.049 mm (2.6397 in.)

Cylinder Bore I.D. – Max. Out-Of-Round 0.150 mm (0.0059 in.)

Cylinder Bore I.D. – Max. Taper 0.100 mm (0.0039 in.)

Cylinder Head

Cylinder Head Fastener Torque 22.6 N•m (200 in. lb.)

Max. Out-Of-Flatness 0.076 mm (0.003 in.)

Electric Starter

Drive Pinion Fastener Torque 17.0–19.0 N•m (150–170 in. lb.)

Drive Pinion-To-Flywheel Ring Gear Backlash 0.127–0.635 mm (0.0050–0.0250 in.)

Flywheel

Flywheel Retaining Screw Torque 67.8 N•m (50 ft. lb.)

Fuel Tank

Fuel Tank Fastener Screw Torque 17.0 N•m (150 in. lb.)

Governor

Governor Cross Shaft Bore I.D. — Max. Wear Limit	6.425 mm (0.2530 in.)
Governor Cross Shaft-To-Closure Plate Bore Running Clearance ..	0.020–0.122 mm (0.0008–0.0048 in.)
Governor Cross Shaft O.D. — Max. Wear Limit	6.296 mm (0.2479 in.)
Governor Gear Shaft-To-Governor Gear Running Clearance	0.025–0.111 mm (0.0010–0.0044 in.)
Governor Gear Shaft O.D. — Max. Wear Limit	9.960 mm (0.3921 in.)

Ignition

Spark Plug Type (Champion Or Equivalent)	RC12YC
Spark Plug Gap	1.02 mm (0.040 in.)
Spark Plug Torque	24.4–29.8 N•m (18–22 ft. lb.)
Ignition Module Air Gap	0.203–0.305 mm (0.0080–0.0120 in.)
Ignition Module Fastener Torque ²	4.0 or 6.2* N•m (35 or 55* in. lb.)

Muffler

Muffler Retaining Nut Torque	22.6 N•m (200 in. lb.)
------------------------------------	------------------------

Oil Sentry™

Oil Sentry™ Float Switch Torque	13.6 N•m (120 in. lb.)
---------------------------------------	------------------------

Piston, Piston Rings, And Piston Pin

Piston-To-Piston Pin Clearance	0.005–0.018 mm (0.0002–0.0007 in.)
Piston Pin Bore I.D. — New	14.006–14.014 mm (0.5514–0.5517 in.)
Piston Pin O.D. — New	13.996–14.000 mm (0.5510–0.5512 in.)
Top Compression Ring-To-Groove Side Clearance	0.040–0.085 mm (0.0016–0.0033 in.)
Middle Compression Ring-To-Groove Side Clearance	0.040–0.072 mm (0.0016–0.0028 in.)
Oil Control Ring-To-Groove Side Clearance	0.140–0.275 mm (0.0055–0.0108 in.)
Top And Center Compression Ring End Gap — New	0.25–0.45 mm (0.010–0.018 in.)
Piston Thrust Face (@D ₁)-To-Cylinder Bore Running Clearance — New ³	0.016–0.059 mm (0.0006–0.0023 in.)

Retractable Starter

Center Screw Torque	7.4–8.5 N•m (65–75 in. lb.)
---------------------------	-----------------------------

SECTION 1

SAFETY AND GENERAL INFORMATION

Throttle Control

Throttle Control lever Fastener Torque 4.3 N•m (38 in. lb.)

Valve Cover

Valve Cover Fastener Torque 3.4 N•m (30 in. lb.)

Valves And Valve Lifters

Intake Valve Stem-To-Valve Guide Running Clearance 0.0392–0.0749 mm (0.00154–0.00295 in.)

Exhaust Valve Stem-To-Valve Guide Running Clearance 0.0610–0.0991 mm (0.00240–0.00390 in.)

Intake Valve Guide I.D. – New 4.990–5.010 mm (0.1965–0.1972 in.)

Intake Valve Guide I.D. – Max. Wear Limit 5.085 mm (0.2002 in.)

Exhaust Valve Guide I.D. – New 4.990–5.010 mm (0.1965–0.1972 in.)

Exhaust Valve Guide I.D. – Max. Wear Limit 5.080 mm (0.2000 in.)

Valve Guide Reamer Size – STD 5.000 mm (0.1968 in.)

Valve Guide Reamer Size – Oversize 5.250 mm (0.2066 in.)

Intake Valve Minimum Lift 5.40 mm (0.213 in.)

Exhaust Valve Minimum Lift 5.40 mm (0.213 in.)

Nominal Valve Seat Angle 45°





Valve-To-Tappet Clearance (Cold) 0.000–0.051 mm (0.0000–0.0020 in.)





NOTES:

1. Values are in Metric units. Values in parenthesis are English equivalents. Lubricate threads with engine oil prior to assembly.
2. For self-tapping (thread forming) fasteners: the higher torque value* is for initial installation into a new cored hole; the lower torque value is for subsequent installation and installation into tapped holes and weld nuts.
3. Measure 6 mm (0.236 in.) above the bottom of the piston skirt at right angles to the piston pin.

TORQUE INFORMATION, SPECIFICATIONS, AND TOLERANCES

Metric Fastener Torque Recommendations For Standard Applications

Tightening Torque: N•m (in. lb.) + or - 10%						
	Property Class					Noncritical Fasteners Into Aluminum
						
Size						
M4	1.2 (11)	1.7 (15)	2.9 (26)	4.1 (36)	5.0 (44)	2.0 (18)
M5	2.5 (22)	3.2 (28)	5.8 (51)	8.1 (72)	9.7 (86)	4.0 (35)
M6	4.3 (38)	5.7 (50)	9.9 (88)	14.0 (124)	16.5 (146)	6.8 (60)
M8	10.5 (93)	13.6 (120)	24.4 (216)	33.9 (300)	40.7 (360)	17.0 (150)

Tightening Torque: N•m (ft. lb.) + or - 10%						
	Property Class					Noncritical Fasteners Into Aluminum
						
Size						
M10	21.7 (16)	27.1 (20)	47.5 (35)	66.4 (49)	81.4 (60)	33.9 (25)
M12	36.6 (27)	47.5 (35)	82.7 (61)	116.6 (86)	139.7 (103)	61.0 (45)
M14	58.3 (43)	76.4 (55)	131.5 (97)	184.4 (136)	219.7 (162)	94.9 (70)

Oil Drain Plugs Tightening Torque: N•m (English Equiv.)

Size	Into Cast Iron	Into Aluminum
1/8" NPT	-----	4.5 (40 in. lb.)
1/4"	17.0 (150 in. lb.)	11.3 (100 in. lb.)
3/8"	20.3 (180 in. lb.)	13.6 (120 in. lb.)
1/2"	27.1 (20 ft. lb.)	17.6 (13 ft. lb.)
3/4"	33.9 (25 ft. lb.)	21.7 (16 ft. lb.)
X-708-1	27.1/33.9 (20/25 ft. lb.)	27.1/33.9 (20/25 ft. lb.)





Torque Conversions

N•m = in. lb. x 0.113
 N•m = ft. lb. x 1.356
 in. lb. = N•m x 8.85
 ft. lb. = N•m x 0.737

SECTION 1

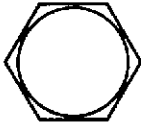
SAFETY AND GENERAL INFORMATION

English Fastener Torque Recommendations For Standard Applications

Tightening Torque: N•m (in. lb.) + or - 20%				
Bolts, Screws, Nuts And Fasteners Assembled Into Cast Iron Or Steel				Grade 2 Or 5 Fasteners Into Aluminum
	 Grade 2	 Grade 5	 Grade 8	
Size				
8-32	2.3 (20)	2.8 (25)	_____	2.3 (20)
10-24	3.6 (32)	4.5 (40)	_____	3.6 (32)
10-32	3.6 (32)	4.5 (40)	_____	_____
1/4-20	7.9 (70)	13.0 (115)	18.7 (165)	7.9 (70)
1/4-28	9.6 (85)	5.8 (140)	22.6 (200)	_____
5/16-18	17.0 (150)	28.3 (250)	39.6 (350)	17.0 (150)
5/16-24	18.7 (165)	30.5 (270)	_____	_____
3/8-16	29.4 (260)	_____	_____	_____
3/8-24	33.9 (300)	_____	_____	_____
Tightening Torque N•m (ft. lb.) + or - 20%				
Size				
5/16-24	_____	_____	40.7 (30)	_____
3/8-16	_____	47.5 (35)	67.8 (50)	_____
3/8-24	_____	54.2 (40)	81.4 (60)	_____
7/16-14	47.5 (35)	74.6 (55)	108.5 (80)	_____
7/16-20	61.0 (45)	101.7 (75)	142.4 (105)	_____
1/2-13	67.8 (50)	108.5 (80)	155.9 (115)	_____
1/2-20	94.9 (70)	142.4 (105)	223.7 (165)	_____
9/16-12	101.7 (75)	169.5 (125)	237.3 (175)	_____
9/16-18	135.6 (100)	223.7 (165)	311.9 (230)	_____
5/8-11	149.2 (110)	244.1 (180)	352.6 (260)	_____
5/8-18	189.8 (140)	311.9 (230)	447.5 (330)	_____
3/4-10	199.3 (150)	332.2 (245)	474.6 (350)	_____
3/4-16	271.2 (200)	440.7 (325)	637.3 (470)	_____

SECTION 2 SPECIAL TOOLS

SPECIAL SERVICE TOOL KITS

These quality tools are designed to help you perform specific disassembly, repair, and reassembly procedures. By using tools designed for the job, you can service engines easier, faster, and safer! In addition, you'll increase your service capabilities and customer satisfaction by decreasing engine down time.

Tool Kit No. KO-3211-A — This basic tool kit includes tools necessary to service Kohler K-Series and Magnum engines. It includes the tools originally sold as kit NU-3211 and the new tools kit no. KO-3212.

Tool Kit No. KO-3212 — This kit updates original tool kit No. NU-3211 to include all new tools released in 1986 and 1987. Specifically, the kit includes tools for fixed jet carburetor welch plug removal and installa-

tion, camshaft pin and camshaft pin cup plug installation, oil seal installation tool, and a tool board.

COMMAND Tool Kit No. KO-3213 — This kit is designed for the current Kohler Engine Service Dealer already having the KO-3211-A basic tool kit. This kit includes all additional tools necessary to service current Command series engines.

COMMAND Tool Kit No. KO-3214 — This kit is for the new Kohler Dealer servicing the Command series engines *only*.

COMMAND Tool Kit No. KO-3215 — This kit is for the new Kohler Dealer servicing the *CV11-14 model only*.

To avoid tool duplication, and to ensure you have all necessary tools, refer to the following table:



IF YOU ARE CURRENTLY	SERVICING	ORDER KIT NO.				
		KO-3211-A	KO-3212	KO-3213	KO-3214	KO-3215
New/Existing Kohler Dealer "No Tools"	K, M, & C	X		X		
Existing Kohler Dealer With NU-3211 Kit	K & M		X			
Existing Kohler Dealer With NU-3211 Kit	K, M, & C		X	X		
Existing Kohler Dealer With KO-3211-A Kit	K, M, & C			X		
Existing Kohler Dealer Command Only	C				X	
Existing Kohler Dealer C 11-14 Only	C					X

K = K-Series Engines
M = Magnum Engines
C = Command Engines

KO-3211-A = Standard Tool Kit For K-Series And Magnum Engines (Includes Kits NU-3211 And KO-3212)
KO-3212 = Add On Kit For NU-3211 (Kit KO-3212 + Kit NU-3211 = Kit KO-3211-A)
KO-3213 = Add On Kit For Command Series Engines (To Be Used With Kit KO-3211-A)
KO-3214 = Command Dealer Tool Kit
KO-3215 = CV11-14 Dealer Tool Kit

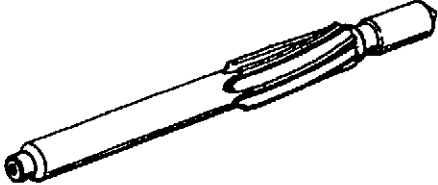
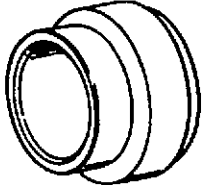
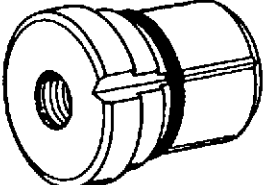
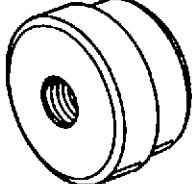

SECTION 2 SPECIAL TOOLS

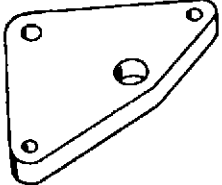
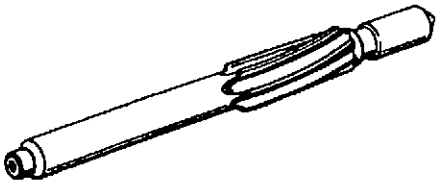
Kit KO-3213 Includes:

Tool No.	Description	Application	Illustration
KO-1026	REAMER (Oversize Valve Guide)	Used to ream valve guides— CV & CH11-14.	
KO-1027	OIL SEAL INSTALLER (Flywheel, PTO)	Used to install oil seals to the proper depth— CV & CH11-14. Use with KO-1036 handle.	
KO-1028	CRANKSHAFT BEARING INSTALLER	Used to install main bearing— CV & CH11-14. Use with NU-4747 handle.	
KO-1029	CRANKSHAFT BEARING REMOVER	Used to remove main bearing— CV & CH11-14. Use with NU-4747 handle.	
KO-1030	GOVERNOR SHAFT SEAL INSTALLER	Used to install governor shaft seal— CV & CH11-14.	
KO-1031	CAMSHAFT ENDPLAY PLATE	Used to check camshaft endplay— CV & CH11-14. (All necessary hard- ware is included.	
KO-1033	REAMER (Oversize Valve Guide)	Used to ream valve guides— CH5 & CH6.	



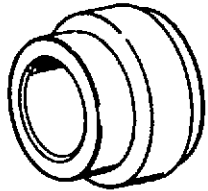
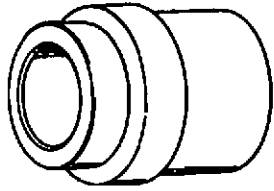

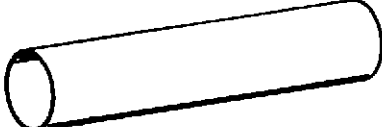
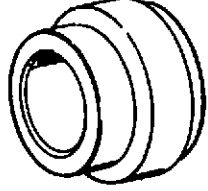
SECTION 2 SPECIAL TOOLS

2

Tool No.	Description	Application	Illustration
KO-1034	OIL SEAL INSTALLER (Flywheel)	Used to install oil seal to the proper depth – CH5 & CH6. Use with KO-1036 handle.	
KO-1035	CAMSHAFT PTO OIL SEAL INSTALLER	Used to install the camshaft PTO oil seal to the proper depth – CH5 & CH6. Use with KO-1036 handle.	
KO-1036	DRIVING HANDLE	Used with oil seal installers.	
KO-1037	SEAL PROTECTOR SLEEVE	Used on crankshaft when installing oil seals – CV & CH11-14.	
208665	HEX CAP SCREW	Used with flywheel puller kit (NU-3226) – All. (M8 x 1.25 x 70 mm)	NOT ILLUSTRATED
10257	FLAT WASHER	Used with flywheel puller kit – All.	
KO-1039	SILO PACK, HOOKS, SCREWS	Used with KO-3213 kit.	
KO-1043	OIL SEAL INSTALLER (PTO)	Used to install seal to the proper depth – CH5 & CH6. Use with KO-1036 handle.	

SECTION 2 SPECIAL TOOLS

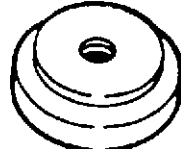
Kit KO-3214 Includes All Of The Above Tools Plus The Following:

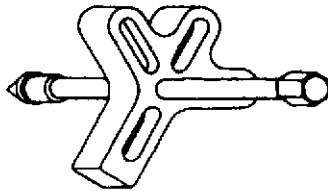
Tool No.	Description	Application	Illustration
NU-4747	HANDLE	Used to install and remove bearings.	
NU-10357	FLYWHEEL STRAP WRENCH	Used to hold flywheel. (For replacement strap, order Part No. 305085.)	
NU-12018	BEARING INSTALLER	Used to install main bearings – CH5 & CH6. Use with NU-4747 handle.	
NU-12021	SEAL PROTECTOR SLEEVE	Used on crankshaft when installing oil seals – CH5 & CH6.	
NU-3226	FLYWHEEL PULLER KIT	Used to remove flywheel. (All hardware included.)	
KO-1038 KO-1040	TOOL BOARD SILO PACK, HOOKS, SCREWS	Used with KO-3214 kit.	NOT ILLUSTRATED

SECTION 2 SPECIAL TOOLS

Kit No. KO-3214 Tool Usage Chart

Tool Number	Description	CH5 & CH6	CV & CH11-14
KO-1026	Reamer, Oversized Valve Guide		X
KO-1027	Oil Seal Installer (Flywheel, PTO)		X
KO-1028	Crankshaft Bearing Installer		X
KO-1029	Crankshaft Bearing Remover		X
KO-1030	Governor Shaft Seal Installer		X
KO-1031	Camshaft Endplay Plate		X
KO-1033	Reamer, Oversized Valve Guide	X	
KO-1034	Oil Seal Installer (Flywheel)	X	
KO-1035	Camshaft PTO Oil Seal Installer	X	
KO-1036	Driving Handle	X	X
KO-1037	Seal Protector Sleeve		X
208665	Hex. Cap Screw (M8 x 1.25 x 70 mm)	X	X
10257	Flat Washers	X	X
208562	Hex. Cap Screws (M8 x 1.25 x 20 mm)		X
KO-1039	Silo Pack, Hooks, And Screws (KO-3213)	X	X
NU-3226	Flywheel Puller Kit	X	X
NU-4747	Handle	X	X
NU-10357	Flywheel Strap Wrench	X	X
NU-12018	Bearing Installer	X	
NU-12021	Seal Protector Sleeve	X	
KO-1038	Tool Board	X	X
KO-1040	Silo Pack, Hooks, And Screws (KO-3214)	X	X
KO-1043	Oil Seal Installer (PTO)	X	X

Service tool kits can be ordered complete or the tools can be ordered individually. Contact your Kohler Distributor for price and availability.

SECTION 2 SPECIAL TOOLS

ENGINE ANALYSIS KIT NO. KO-1000

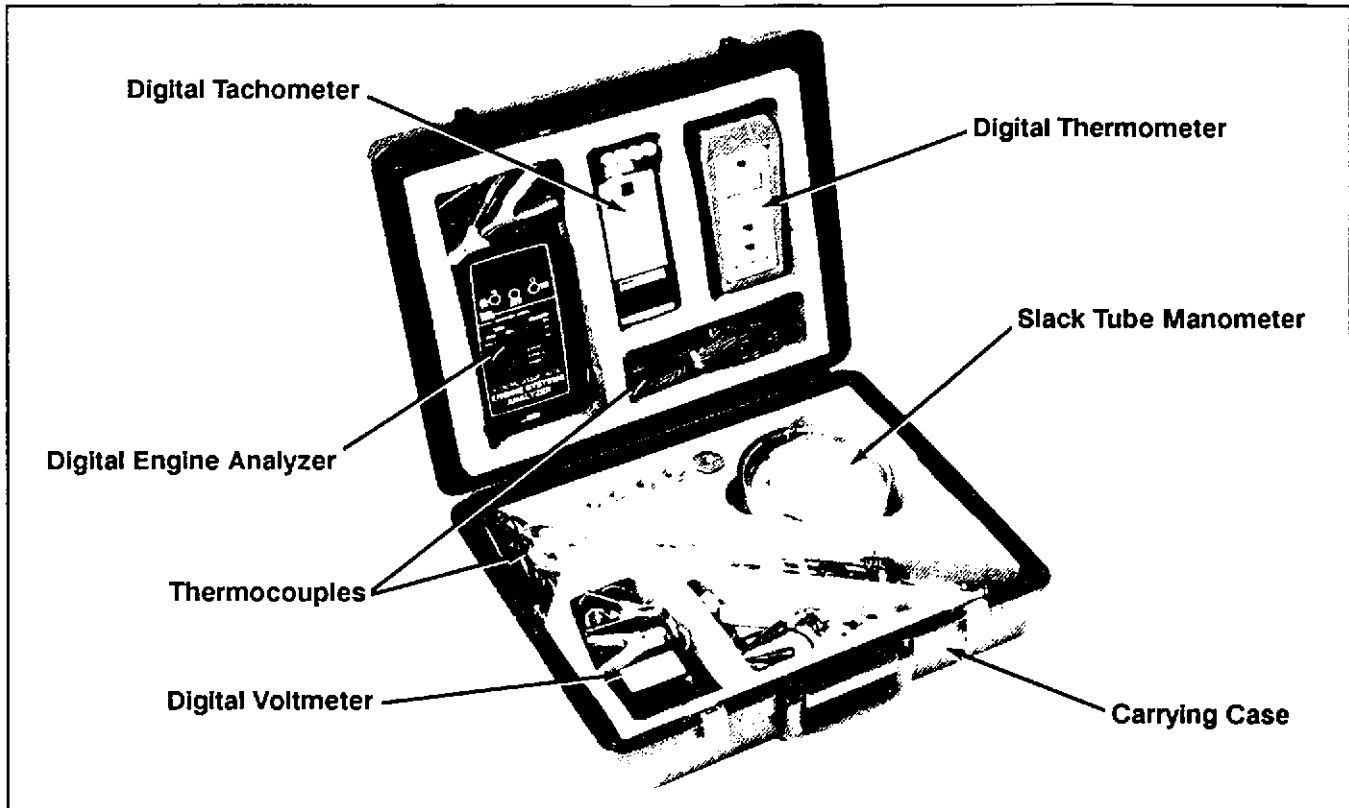

Figure 2-1. Engine Analysis Kit – KO-1000

The Kohler Engine Analysis Kit contains a selection of instruments that will enable you to measure critical items that relate to engine performance. You will find many uses for these instruments – from basic crank-case vacuum checks to sophisticated application tests.

The Engine Analysis Kit Includes:

Qty.	Description	Part No.
1	Digital Voltmeter	KO-1001
1	Digital Tachometer	KO-1002
1	Digital Thermometer	KO-1004
1	Digital Engine Analyzer	KO-1003
1	Slack Tube Manometer	KO-1005
1	8 ft. Lead With Plug	KO-1006
3	14mm Spark Plug	
	Thermocouple	KO-1007
2	Head Bolt Thermocouple	KO-1008
1	Oil Sump Thermocouple	KO-1009
1	1/4" x 1/8" Bushing	KO-1010-B
1	3/8" x 1/8" Bushing	KO-1010-A
1	1/2" x 1/8" Bushing	KO-1010-C
1	3/4" x 1/8" Bushing	KO-1010-D
1	Tube With Fittings	KO-1011-B
1	Carrying Case	KO-1013
3	Plain Thermocouple	KO-1015

The voltmeter, tachometer, and engine analyzer feature electronic circuitry and digital readouts. Guidelines for using the instruments and testing are included.

Using the instruments in the kit you will be able to:

1. Measure the temperatures of the:
 - a. spark plug base gasket/cylinder head bolt,
 - b. oil sump, and
 - c. air into flywheel and carburetor.
2. Measure engine speed (rpm).

3. Measure crankcase vacuum and exhaust system back pressure.
4. Measure voltage.
5. Measure charging system current.
6. Measure electric starter current (Amp) draw.

The Engine Analysis Kit can be ordered complete as shown, or the instruments can be ordered individually. Contact your Kohler Distributor for price and availability.

IGNITION SYSTEM TESTER

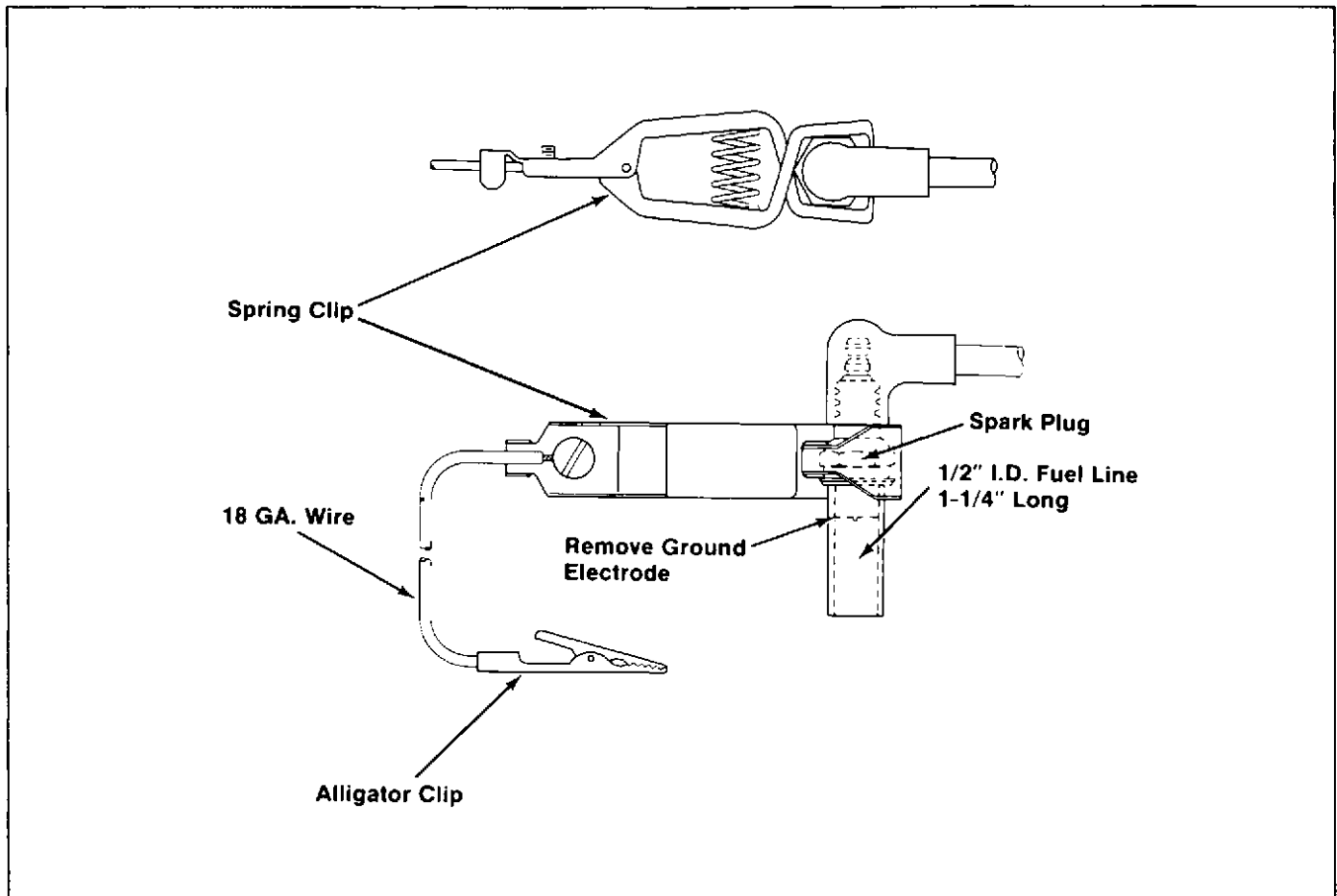

Figure 2-2. Electronic Magneto Ignition System Tester.

SECTION 2 SPECIAL TOOLS

These engines are equipped with a dependable electronic magneto ignition system. A simple tester can be used to determine if the ignition module is functioning properly. See Figure 2-2.

Tester Construction

1. Obtain a new RJ-8 or RCJ-8 spark plug.
2. Remove the ground electrode from the spark plug. This give a spark gap of approx. 3.3 mm (0.13 in.). This large gap simulates the spark required under actual engine conditions.
3. Make a lead assembly using a large spring clip, an alligator clip, and 18 gauge wire.
4. Cut a 32 mm (1-1/4 in.) length of 13 mm (1/2 in.) I.D. fuel line. Slide it onto the threads of the test plug. The fuel line shades the firing tip to make the spark more visible.

Using The Tester

Follow the instructions given in Section 8 – “Electrical System And Components.”

RTV SILICONE SEALANT

RTV silicone sealant is used as a gasket between the crankcase and closure plate.

An easy-to-use **silicone sealant dispenser tube, Part No. 52 597 02**, is available. This dispenser tube contains 2.8 fl. oz. of RTV-108.

To order, contact your source of supply.

WATER MANOMETER

The Kohler Part No. 25 800 50 U-Tube water manometer is a useful tool to check crankcase vacuum (or pressure) and to check for exhaust back pressure. It can also be used to adjust primary regulators used with gaseous fuel systems. Complete instructions are provided in the kit.

CYLINDER LEAKDOWN TESTER

The Kohler Part No. 47 800 02 Cylinder Leakdown Tester is a valuable alternate to a compression test on these ACR equipped engines. By pressurizing the combustion chamber from an external air source, this tool can determine if valves or rings are leaking. Instruction for using this tester are found on page 3.4 of this manual.

SECTION 3 TROUBLESHOOTING

TROUBLESHOOTING GUIDE

When troubles occur, be sure to check the simple causes which, at first, may seem too obvious to be considered. For example, a starting problem could be caused by an empty fuel tank.

Some common causes of engine troubles are listed below. Use these to locate the causing factors.

Engine Cranks But Will Not Start

1. Empty fuel tank
2. Fuel shutoff valve closed
3. Dirt or water in the fuel system
4. Clogged fuel line
5. Spark plug lead disconnected
6. Key switch or kill switch in "off" position
7. Faulty spark plug
8. Faulty ignition module

Engine Starts But Does Not Keep Running

1. Restricted fuel tank cap vent
2. Dirt or water in the fuel system
3. Faulty choke or throttle controls
4. Loose wires or connections that short the kill terminal of ignition module to ground
5. Faulty cylinder head gasket
6. Faulty carburetor

Engine Starts Hard

1. PTO drive is engaged
2. Dirt or water in the fuel system
3. Clogged fuel line
4. Loose or faulty wires or connections
5. Faulty choke or throttle controls
6. Faulty spark plug
7. Low compression
8. Faulty ACR mechanism

Engine Will Not Crank

1. PTO drive is engaged
2. Battery (if equipped) is discharged
3. Safety interlock switch is engaged
4. Loose or faulty wires or connections
5. Faulty key switch or ignition switch
6. Faulty electric starter (if equipped)
7. Retractable starter not engaging in drive cup
8. Seized internal engine components

Engine Runs But Misses

1. Dirt or water in the fuel system
2. Spark plug lead disconnected
3. Loose wires or connections that intermittently short the kill terminal of ignition module to ground
4. Engine overheated
5. Faulty ignition module

Engine Will Not Idle

1. Restricted fuel tank cap vent
2. Dirt or water in the fuel system
3. Faulty spark plug
4. Idle fuel adjusting needle improperly set
5. Idle speed adjusting screw improperly set
6. Low compression

Engine Overheats

1. Air intake/grass screen, cooling fins, or cooling shrouds clogged
2. Excessive engine load
3. Low crankcase oil level
4. High crankcase oil level
5. Faulty carburetor

Engine Knocks

1. Excessive engine load
2. Low crankcase oil level
3. Old/improper fuel
4. Internal wear or damage

SECTION 3

TROUBLESHOOTING

Engine Loses Power

1. Low crankcase oil level
2. High crankcase oil level
3. Dirty air cleaner element
4. Dirt or water in the fuel system
5. Excessive engine load
6. Engine overheated
7. Faulty spark plug
8. Low compression
9. Exhaust restriction

Engine Uses Excessive Amount Of Oil

1. Incorrect oil viscosity/type
2. Clogged or improperly-assembled breather
3. Worn or broken piston rings
4. Worn cylinder bore
5. Worn valve stems/valve guides

EXTERNAL ENGINE INSPECTION

Before cleaning or disassembling the engine, make a thorough inspection of its external appearance and condition. This inspection can give clues to what might be found inside the engine (and the cause) when it is disassembled.

- Check for buildup of dirt and debris on the crankcase, cooling fins, grass screen and other external surfaces. Dirt or debris on these areas are causes of overheating.
- Check for obvious fuel and oil leaks, and damaged components. Excessive oil leakage can indicate a clogged or improperly-assembled breather, worn or damaged seals and gaskets, or loose or improperly-torqued fasteners.
- Check the air cleaner cover and base for damage or indications of improper fit and seal.
- Check the air cleaner element. Look for holes, tears, cracked or damaged sealing surfaces, or other damage that could allow unfiltered air into

the engine. Also note if the element is dirty or clogged. These could indicate that the engine has been underserviced.

- Check the carburetor throat for dirt. Dirt in the throat is further indication that the air cleaner is not functioning properly.
- Check the oil level. Note if the oil level is within the operating range on the dipstick, or if it is low or overfilled.
- Check the condition of the oil. Drain the oil into a container—the oil should flow freely. Check for metal chips and other foreign particles.

Sludge is a natural by-product of combustion; a small accumulation is normal. Excessive sludge formation could indicate the oil has not been changed at the recommended intervals, the incorrect type or weight of oil was used, overrich carburetion, and weak ignition, to name a few.

NOTE: It is good practice to drain oil at a location away from the workbench. Be sure to allow ample time for complete drainage.

CLEANING THE ENGINE

After inspecting the external condition of the engine, clean the engine thoroughly before disassembling it. Also clean individual components as the engine is disassembled. Only clean parts can be accurately inspected and gauged for wear or damage. There are many commercially available cleaners that will quickly remove grease, oil, and grime from engine parts. When such a cleaner is used, *follow the manufacturer's instructions and safety precautions carefully.*

Make sure all traces of the cleaner are removed before the engine is reassembled and placed into operation. Even small amounts of these cleaners can quickly break down the lubricating properties of engine oil.

BASIC ENGINE TESTS

Crankcase Vacuum Test

A partial vacuum should be present in the crankcase when the engine is operating at normal temperatures. Pressure in the crankcase (normally caused by a clogged or improperly-assembled breather) can cause oil to be forced out at oil seals, gaskets, or other available spots.

Crankcase vacuum is best measured with a water manometer. Kohler Part No. 25 800 50 is recommended. Complete instructions are provided in kit.

Test the crankcase vacuum with the manometer as follows:

1. Insert the stopper/hose into the oil fill hole. Leave the other vent hose of manometer open to atmosphere.

Make sure the shut-off clamp is closed.

2. Start the engine and run at no-load high idle speed (3200 to 3750 RPM).
3. Open the clamp and note the water level in the tube.

The level in the engine side should be a minimum of **10.2 cm (4 in.)** above the level in the open side.

If the level in the engine side is the same as the open side (no vacuum), or the level in the engine side is lower than the level in the open side (pressure), check for the conditions in the table below.

4. Close the shut-off clamp **before** stopping the engine.

Compression Test

These engines are equipped with an automatic compression release (ACR) mechanism. Because of the ACR mechanism, it is difficult to obtain an accurate compression reading. As an alternate, use the leak-down test described in the following:

NO CRANKCASE VACUUM/PRESSURE IN CRANKCASE

Possible Cause	Solution
1. Crankcase breather clogged or inoperative.	1. Disassemble breather, clean parts thoroughly, reassemble, and recheck pressure.
2. Seals and/or gaskets leaking. Loose or improperly-torqued fasteners.	2. Replace all worn or damaged seals and gaskets. Make sure all fasteners are tightened securely. Use appropriate torque values and sequences when necessary.
3. Piston blowby or leaky valves. (Confirm by inspecting components.)	3. Recondition piston, rings, cylinder bore, valves, and valve guides.
4. Restricted exhaust.	4. Repair/replace restricted muffler/exhaust system.

SECTION 3

TROUBLESHOOTING

Cylinder Leakdown Test

A cylinder leakdown test can be a valuable alternative to a compression test. By pressurizing the combustion chamber from an external air source you can determine if the valves or rings are leaking, and how badly.

The Kohler Part No. 47 800 02 is a relatively simple, inexpensive leakdown tester for small engines. The tester includes a quick disconnect for attaching the adapter hose, a holding tool and instructions.

Leakdown Test Instructions

1. Run engine for 3–5 minutes to warm it up.
2. Remove spark plug(s) and air filter from engine.
3. Rotate crankshaft until piston (of cylinder being tested) is at top dead center of compression stroke. You will need to hold the engine in this position while testing. The holding tool supplied with the tester can be used if the PTO end of the crankshaft is accessible. Slide the holding tool onto the crankshaft and adjust the set screw to fit in the key slot. Install a 3/8" breaker bar into the

square hole of the holding tool, so it is perpendicular to both the holding tool and crankshaft PTO. If the flywheel end is more accessible, you can use a breaker bar and socket on the flywheel nut/screw to hold it in position. You may need an assistant to hold the breaker bar during testing. If the engine is mounted in a piece of equipment, you may be able to hold it by clamping or wedging a driven component. Just be certain that the engine cannot rotate off of T.D.C. in either direction.

4. Install the adapter into the spark plug hole, but do not attach it to the tester at this time.
5. Connect an adequate air source to the tester.
6. Turn the regulator knob in the increase (clockwise) direction until the gauge needle is in the yellow "set" area at the low end of the scale.
7. Connect tester quick-disconnect to the adapter. Note the gauge reading and listen for escaping air at the carburetor intake, exhaust outlet, and crankcase breather.
8. Check your test results against the table below:

LEAKDOWN TEST RESULTS

Air escaping from crankcase breather	Defective rings or worn cylinder walls.
Air escaping from exhaust system	Defective exhaust valve.
Air escaping from carburetor	Defective intake valve.
Gauge reading in "low" (green) zone	Piston rings and cylinder in good condition.
Gauge reading in "moderate" (yellow) zone	Engine is still usable, but there is some wear present. Customer should start planning for overhaul or replacement.
Gauge reading in "high" (red) zone	Rings and/or cylinder have considerable wear. Engine should be reconditioned or replaced.

SECTION 4A (CH5) AIR CLEANER & AIR INTAKE SYSTEM

4

AIR CLEANER (CH5)

This engine is equipped with a replaceable, high-density paper air cleaner element and an oiled-foam precleaner (which covers the paper element). See Figures 4A-1 and 4A-2.

NOTE: Refer to Section 4B for details on air cleaner used on CH6 models.

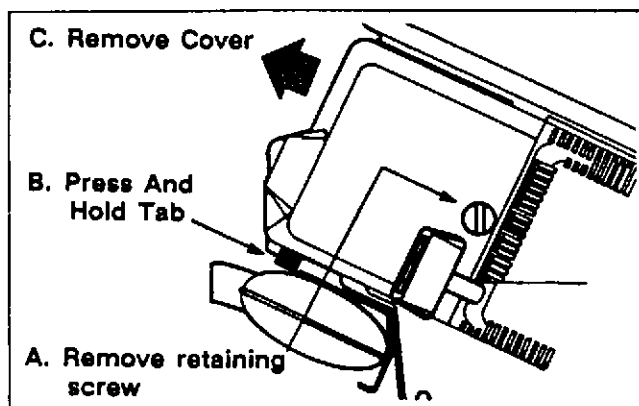

Figure 4A-1. Removing CH5 Air Cleaner Cover.

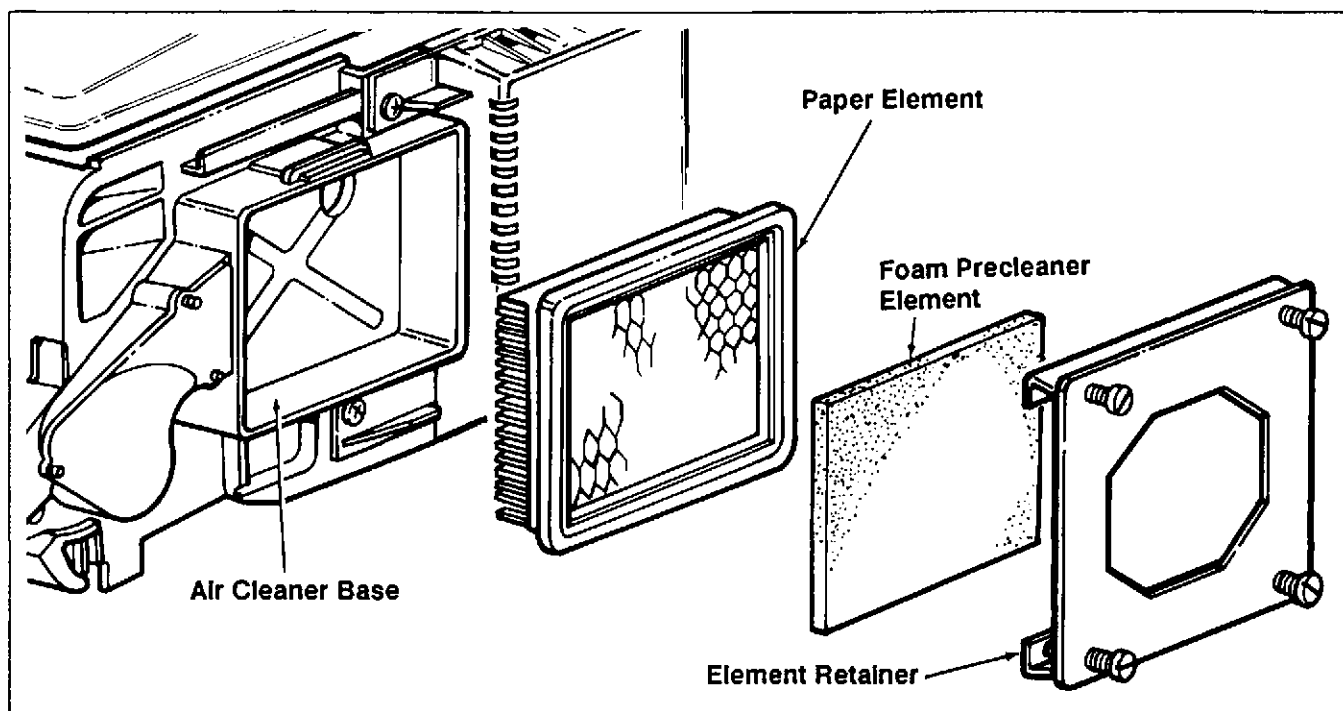

Figure 4A-2. CH5 Air Cleaner Components.

SECTION 4A – CH5

AIR CLEANER & AIR INTAKE SYSTEM

Air Cleaner Service (CH5)

Check the air cleaner **daily or before starting the engine**. Check for and correct heavy buildup of dirt and debris, and loose or damaged components.

NOTE: Operating the engine with loose or damaged air cleaner components could allow unfiltered air into the engine, causing premature wear and failure.

Service Precleaner (CH5)

Wash and reoil the precleaner every **25 hours** of operation (more often under extremely dusty or dirty conditions).

1. Remove the air cleaner cover as follows:
 - a. Remove the retaining screw (if so equipped).
 - b. Press and hold the tab at the bottom of the air cleaner cover.

NOTE: Choke control must be in the "OFF" position.
 - c. Slide the air cleaner cover off of the air cleaner base (away from the retractable starter).
2. Remove the precleaner from the air cleaner element retainer.
3. Wash the precleaner in warm water with detergent. Rinse the precleaner thoroughly until all traces of detergent are eliminated. Squeeze out excess water (do not wring). Allow the precleaner to air-dry.
4. Saturate the precleaner with new engine oil. Squeeze out all excess oil.
5. Reinstall the precleaner in the element retainer.
6. Reinstall the air cleaner cover. Make sure the air cleaner cover latch "snaps" securely.

Service Paper Element (CH5)

Every **100 hours** of operation (more often under extremely dusty or dirty conditions), check the paper element. Replace the element as necessary.

1. Remove the air cleaner cover. See "Service Precleaner", Step 1.
2. Remove the precleaner from the air cleaner element retainer.
3. Remove the element retainer and paper element from the air cleaner base as follows:
 - a. Loosen the four slot head screws in the element retainer.

NOTE: Do not remove screws.

- b. When screws are loosened sufficiently, unhook element retainer from bottom tabs on air cleaner base. Remove element retainer.
 - c. Remove paper element.
 4. Replace a dirty, bent, or damaged element with a genuine Kohler element. Do not wash the paper element or use pressurized air, as this will damage the element. Handle new elements carefully; do not use if the sealing surfaces are bent or damaged.
 5. When servicing the air cleaner, check the air cleaner base. Make sure it is secured and not bent or damaged. Also check the air cleaner element retainer for damage or improper fit. Replace all bent or damaged air cleaner components.
 6. Reinstall the paper element, element retainer, and precleaner as follows:

- a. Place the paper element into the air cleaner base.

NOTE: The pleats must run parallel to the cylinder.

- b. Hook the element retainer into the top of the air cleaner base. Then hook the retainer into the bottom of the base to hold the paper element in place.

NOTE: Be sure retainer is hooked on tabs.

- c. Tighten the four slot head screws evenly.

NOTE: These screws must be snug to eliminate any air leaks around paper element.

- d. Reinstall the precleaner in the element retainer.

Inspect CH5 Air Cleaner Components

Whenever the air cleaner cover is removed, or the paper element or precleaner are serviced, check the following areas/components:

Air Cleaner Base – Make sure the base is secured and not cracked or damaged. Since the air cleaner base and carburetor are secured to the intake port with common hardware, it is extremely important that the nuts securing these components are tight at all times.

Breather Tube – Make sure the tube is installed to both the air cleaner base and valve cover.

NOTE: Damaged, worn, or loose air cleaner components can allow unfiltered air into the engine causing premature wear and failure. Tighten or replace all loose or damaged components.

Disassembly – CH5 Air Cleaner

The following procedure is for complete disassembly of all air cleaner components.

1. Remove the air cleaner cover. See “Service Precleaner”, Step 1.
2. Remove the precleaner from the air cleaner element retainer.
3. Remove the element retainer and paper element from the air cleaner base. See “Service Paper Element”, Step 3.
4. Remove the two air cleaner base mounting screws and the two air cleaner base mounting nuts.
5. Disconnect the breather tube from the air cleaner base, and remove the air cleaner base and gasket.

Reassembly – CH5 Air Cleaner

Before reinstalling an air cleaner base that has been removed, make sure the four metal bushings, which reinforce the base mounting holes and maintain the proper torque of the mounting hardware, are in place. See Figure 4A-3.

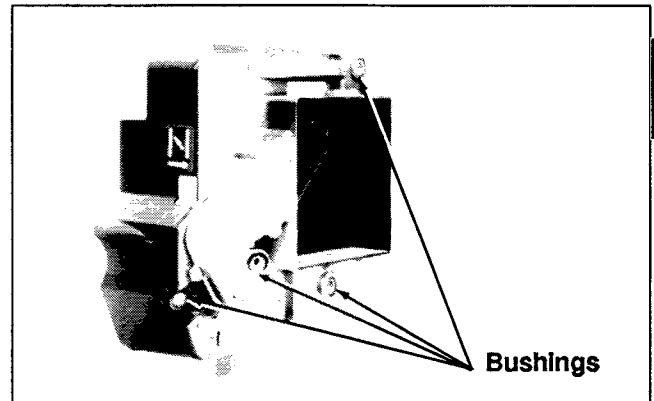

Figure 4A-3. Bushings In CH5 Air Cleaner Base.

1. Install the gasket and air cleaner base, and connect the breather tube to the air cleaner base.
2. Install the air cleaner base mounting nuts and screws. Torque each fastener to **6.8 N•m (58 In. lb.)**.
3. Install the paper element, element retainer, and precleaner. See “Service Paper Element”, Step 6.

CLEAN AIR INTAKE/COOLING AREAS

To ensure proper cooling, make sure the grass screen, cooling fins, and other external surfaces of the engine are kept clean **at all times**.

Every **100 hours** of operation (more often under extremely dusty or dirty conditions), remove the blower housing and other cooling shrouds. Clean the cooling fins and external surfaces as necessary. Make sure the cooling shrouds are reinstalled.

NOTE: Operating the engine with a blocked grass screen, dirty or plugged cooling fins, and/or cooling shrouds removed, will cause engine damage due to overheating.

SECTION 4B (CH6)

AIR CLEANER & AIR INTAKE SYSTEM

AIR CLEANER SERVICE (CH6)

This engine is equipped with a replaceable, high-density paper air cleaner element. All engines are also equipped with an oiled-foam precleaner which covers the paper element. See Figure 4B-1.

Check the air cleaner **daily or before starting the engine**. Check for and correct heavy buildup of dirt and debris, and loose or damaged components.

NOTE: Operating the engine with loose or damaged air cleaner components could allow unfiltered air into the engine causing premature wear and failure.

Service Precleaner (CH6)

Wash and reoil the precleaner every **25 hours** of operation (more often under extremely dusty or dirty conditions).

1. Remove the air cleaner cover as follows:
 - a. Loosen air cleaner cover retaining knob.

NOTE: Choke control must be in the "OFF" position.

- b. Slide the air cleaner cover off of the air cleaner base (away from retractable starter).

2. Remove the precleaner from the air cleaner element.
3. Wash the precleaner in warm water with detergent. Rinse the precleaner thoroughly until all traces of detergent are eliminated. Squeeze out excess water (do not wring). Allow the precleaner to air-dry.
4. Saturate the precleaner with new engine oil. Squeeze out all excess oil.
5. Reinstall the precleaner over the element.
6. Reinstall the air cleaner cover.
7. Tighten the air cleaner cover retaining knob.

Service Paper Element (CH6)

Every **100 hours** of operation (more often under extremely dusty or dirty conditions), check the paper element. Replace the element as necessary.

1. Remove the air cleaner cover. (See "Service Precleaner", Step 1.)

SECTION 4B – CH6 AIR CLEANER & AIR INTAKE SYSTEM

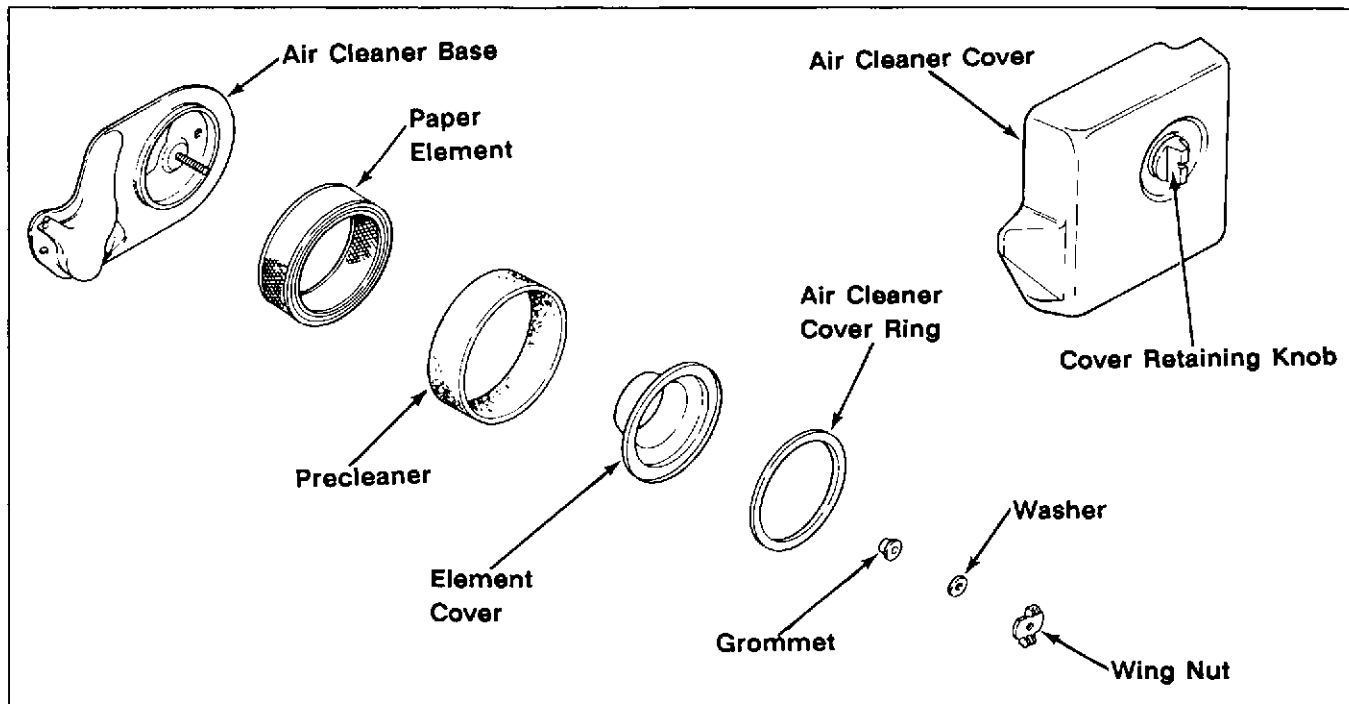

Figure 4B-1. CH6 Air Cleaner Components.

2. Remove the precleaner from the air cleaner element.
3. Remove the air cleaner cover ring, element cover w/grommet, washer and wing nut. Pull the element cover w/grommet off. Remove paper element.
4. Replace a dirty, bent, or damaged element with a genuine Kohler element. Do not wash the paper element or use pressurized air, as this will damage the element. Handle new elements carefully; do not use if the sealing surfaces are bent or damaged.
5. When servicing the air cleaner, check the air cleaner base. Make sure it is secured and not bent or damaged. Also check the air cleaner element cover for damage or improper fit. Replace all bent or damaged air cleaner components.
6. Install new or serviced paper element and components as follows:
 - a. Position paper element on base.
 - b. Slide element cover w/grommet then washer onto stud, secure with wing nut.
 - c. Reinstall the precleaner over the paper element.
 - d. Reinstall air cleaner cover ring into element cover.
 - e. Reinstall air cleaner cover and secure with the retaining knob.

Disassembly-CH6 Air Cleaner Components

The following procedure is for complete disassembly of all CH6 air cleaner components. Refer to Figure 4B-1 for sequence.

1. Remove air cleaner components following Steps 1 through 5 under the "SERVICE PAPER ELEMENT CH6" heading in this Section.
2. Remove the two air cleaner base to block mounting screws and the two air cleaner base to carburetor mounting nuts.
3. Disconnect the breather tube from the air cleaner base, remove the air cleaner base and gasket to complete disassembly of the air cleaner components.

**Reassembly-CH6 Air Cleaner
Components**

Reassembly of the CH6 air cleaner components is essentially the reverse of the disassembly procedure. To reassemble:

1. Reattach the base to the carburetor using the new gasket with the two mounting nuts and the base to the block with two screws. Torque these to **6.8 N•m (58 in. lb.)**.
2. Reverse steps found in CH6 Disassembly procedure above.

CLEAN AIR INTAKE/COOLING AREAS

To ensure proper cooling, make sure the grass screen, cooling fins, and other external surfaces of the engine are kept clean **at all times**.

Every **100 hours** of operation (more often under extremely dusty, dirty conditions), remove the blower housing and other cooling shrouds. Clean the cooling fins and external surfaces as necessary. Make sure the cooling shrouds are reinstalled.

NOTE: Operating the engine with a blocked grass screen, dirty or plugged cooling fins, and/or cooling shrouds removed, will cause engine damage due to overheating.

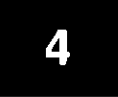

SECTION 5

FUEL SYSTEM AND GOVERNOR

FUEL RECOMMENDATIONS



WARNING: Explosive Fuel!

Gasoline is extremely flammable and its vapors can explode if ignited. Store gasoline only in approved containers, in well-ventilated, unoccupied buildings, away from sparks or flames. Do not fill the fuel tank while the engine is hot or running, since spilled fuel could ignite if it comes in contact with hot parts or sparks from ignition. Do not start the engine near spilled fuel. Never use gasoline as a cleaning agent.

General Recommendations

Purchase gasoline in small quantities and store in clean, approved containers. A container with a capacity of 2 gallons or less with a pouring spout is recommended. Such a container is easier to handle and helps eliminate spillage during refueling.

Do not use gasoline left over from the previous season, to minimize gum deposits in your fuel system and to insure easy starting.

Do not add oil to the gasoline.

Do not overfill the fuel tank. Leave some room for the fuel to expand.

Fuel Type

For best results, use only clean, fresh, unleaded gasoline with a pump sticker octane rating of 87 or higher. In countries using the Research method, it should be 90 octane minimum.

Unleaded gasoline is recommended, as it leaves less combustion chamber deposits. Leaded gasoline may be used in areas where unleaded is not available and exhaust emissions are not regulated. Be aware however, that the cylinder head will require more frequent service.

Gasoline/Alcohol blends

Gasohol (up to 10% ethyl alcohol, 90% unleaded gasoline by volume) is approved as a fuel for Kohler engines. Other gasoline/alcohol blends are not approved.

Gasoline/Ether blends

Methyl Tertiary Butyl Ether (MTBE) and unleaded gasoline blends (up to a maximum of 15% MTBE by volume) are approved as a fuel for Kohler engines. Other gasoline/ether blends are not approved.

FUEL SYSTEM

The typical fuel system and related components include the fuel tank, in-line fuel filter, fuel shut-off valve, carburetor, and interconnecting fuel lines.

Operation

The fuel from the tank is moved through the in-line filter and fuel lines by gravity.

Fuel then enters the carburetor float bowl and is moved into the carburetor body. There, the fuel is mixed with air. This fuel-air mixture is then burned in the engine combustion chamber.

SECTION 5

FUEL SYSTEM AND GOVERNOR

Troubleshooting Fuel System: Use the following procedure to check if fuel is reaching the combustion chamber.

Test	Conclusion
<p>1. Check for the following:</p> <p>A. Make sure the fuel tank contains fuel.</p> <p>B. Make sure the vent in fuel tank cap is not blocked.</p> <p>C. Make sure the fuel shutoff valve is open.</p>	
<p>2. Check for fuel in the combustion chamber.</p> <p>A. Disconnect the spark plug lead.</p> <p>B. Close the choke on the carburetor.</p> <p>C. Crank the engine several times.</p> <p>D. Remove the spark plug and check for fuel at the tip.</p>	<p>2. If there is fuel at the tip of the spark plug, fuel is reaching the combustion chamber.</p> <p>If there is no fuel at the tip of the spark plug, check for fuel flow from the fuel tank. (Test 3.)</p>
<p>3. Check for fuel flow from the tank to the carburetor.</p> <p>A. Remove the fuel line from the inlet fitting of the carburetor.</p> <p>B. Hold the line below the bottom of the tank. Open the shutoff valve (if so equipped) and observe flow.</p>	<p>3. If fuel does flow from the line, check for faulty carburetor. Refer to the "Carburetor" portions of this Section.</p> <p>If fuel does not flow from the line, check for clogged fuel tank cap vent, fuel tank filter screen, fuel shutoff valve, fuel lines, and in-line fuel filter.</p>

CARBURETOR

Model CH5 engines use fixed main jet carburetors made by Walbro to Kohler specifications while most CH6 models use fixed main jet Keihin carburetors. Some CH6 use Walbro carburetors with adjustable main fuel jet. Differences are pointed out wherever pertinent in this subsection which covers the troubleshooting, adjustment and service procedures for the carburetors.



WARNING: Explosive Fuel!

Gasoline may be present in the carburetor and fuel system. Gasoline is extremely flammable and its vapors can explode if ignited. Keep sparks, open flames, and other sources of ignition away from the engine. Disconnect and ground the spark plug lead to prevent the possibility of sparks from the ignition system.

Troubleshooting Checklist

If engine troubles are experienced that appear to be fuel system related, check the following areas before adjusting or disassembling the carburetor.

- Make sure the fuel tank is filled with clean, fresh gasoline.
- Make sure the fuel tank cap vent is not blocked and that it is operating properly.
- Make sure fuel line(s) is unrestricted.
- Make sure the fuel tank filter screen is clean and unobstructed.
- If the fuel tank is equipped with a shutoff valve, make sure it is open and unobstructed.
- If the engine is equipped with an in-line fuel filter, make sure it is clean and unobstructed. Replace the filter if necessary.
- Make sure the air cleaner base and carburetor are securely fastened to the engine using gaskets in good condition.
- Make sure the air cleaner element is clean and all air cleaner components are fastened securely.
- Make sure the ignition system, governor system, exhaust system, and throttle and choke controls are operating properly.

SECTION 5

FUEL SYSTEM AND GOVERNOR

If, engine starting or running problems persist similar to those listed in the following table, it may be necessary to adjust or service the carburetor.

Carburetor Adjustment(s)

NOTE: Carburetor adjustments should be made only after the engine has warmed up!

The carburetor is designed to deliver the correct fuel-to-air mixture to the engine under all operating conditions. The main fuel jet on fixed jet type carburetors is calibrated at the factory and is not adjustable. The idle fuel adjusting needle is also set at the factory and normally does not need adjustment.

TROUBLESHOOTING – CARBURETOR

Condition	Possible Cause/Probable Remedy
1. Engine starts hard, or runs roughly or stalls at idle speed.	1. Low idle fuel mixture or speed are improperly adjusted. Adjust the low idle speed screw, then adjust the low idle fuel needle.
2. Engine runs rich. (Indicated by black, sooty exhaust smoke, misfiring, loss of speed and power, governor hunting, or excessive throttle opening.)	2a. Choke partially closed during operation. Check the choke lever/linkage to ensure choke is operating properly. b. Low idle fuel mixture is improperly adjusted. Adjust low idle fuel needle. c. Float level is set too high. With fuel bowl removed and carburetor inverted, the exposed surface of float must be parallel with the bowl gasket surface of the carburetor body. d. Dirt under the fuel inlet needle. Remove needle; clean needle and seat and blow with compressed air. e. Bowl vent or air bleeds plugged. Remove fuel bowl, low idle fuel adjusting needle, and welch plugs. Clean vent, ports, and air bleeds. Blow out all passages with compressed air. f. Fuel bowl gasket leaks. Remove fuel bowl and replace gasket. g. Leaky, cracked, or damaged float. Submerge float to check for leaks. h. Air cleaner restricted.
3. Engine runs lean. (Indicated by misfiring, loss of speed and power, governor hunting, or excessive throttle opening.)	3a. Low idle fuel mixture is improperly adjusted. Adjust low idle fuel needle. b. Float level is set too low. With fuel bowl removed and carburetor inverted, the exposed surface of float must be parallel with the bowl gasket surface of the carburetor body. c. Idle holes plugged; dirt in fuel delivery channels. Remove fuel bowl, low idle fuel adjusting needle, and welch plugs. Clean main fuel jet and all passages; blow out with compressed air.
4. Fuel leaks from carburetor.	4a. Float level set too high. See Remedy 2c. b. Dirt under fuel inlet needle. See Remedy 2d. c. Bowl vent plugged. Remove fuel bowl and clean bowl vent. Blow out with compressed air. d. Float is cracked or damaged. Replace float. e. Bowl retaining screw gasket damaged. Replace gasket. f. Bowl retaining screw loose. Torque screw to specifications.

SECTION 5 FUEL SYSTEM AND GOVERNOR

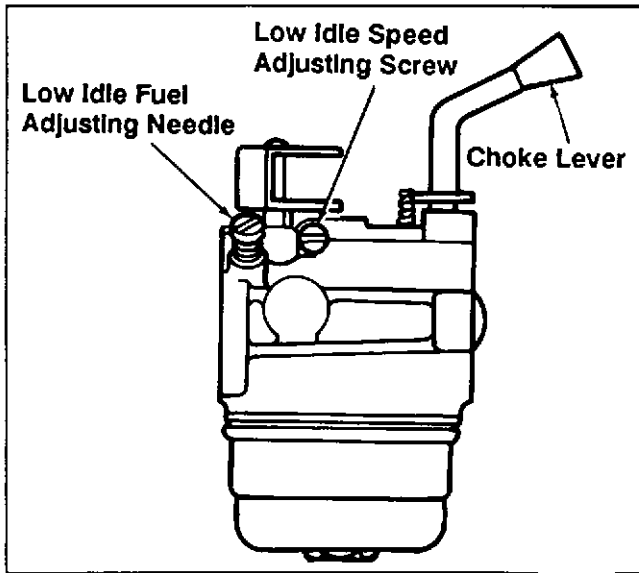

Figure 5-1A. Walbro CH5 Fixed Main Jet Carburetor.

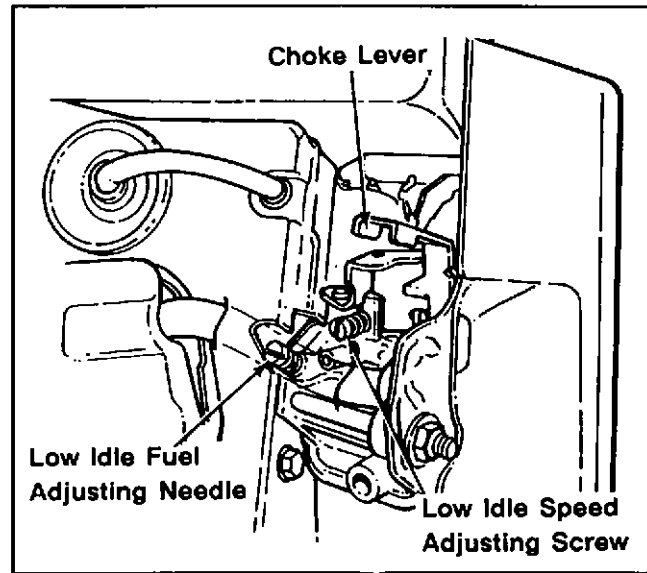

Figure 5-1B. Keihin CH6 Fixed Main Jet Carburetor.

CH5 model engines use fixed main jet type Walbro Carburetors as shown in Figure 5-1A. Most CH6 models also used fixed main type carburetors but these are made for Kohler by Keihin (see Figure 5-1B). Certain CH6 models use Walbro carburetors with adjustable main fuel jet as shown in Figure 5-1C. These allow adjusting for altitude increases.

NOTE: If an engine with fixed main jet type carburetor is operated at altitudes above 1830 meters (6000 ft.) above sea level, the carburetor may require a special "high" altitude main jet.

If the engine is hard-starting, runs rough or stalls at low speed, readjust the carburetor as follows:

1. With the engine **stopped**, turn the low idle fuel adjusting needle in until it bottoms **lightly**. On engines with adjustable main fuel, also turn the main fuel adjusting needle all the way in until it bottoms **lightly**.

NOTE: The tip of the fuel adjusting needles are tapered to critical dimensions. Damage to the needles and needle seats in the carburetor body will result if the needles are forced closed!

2. Preliminary Settings: Turn the needle (or needles) counterclockwise from lightly bottomed to the positions listed below:

IDLE FUEL – 1-1/4 TURNS OPEN
MAIN FUEL – 1-1/8 TURNS OPEN
(adjustable type only)

3. Start the engine and allow it to run at half throttle for five to ten minutes to warm up. If possible, place the engine under load while adjusting.
4. **Main Fuel Needle Setting:** This adjustment is required only for adjustable main jet carburetors. If the carburetor is a fixed main jet type, disregard this setting.

Place the throttle into the fast position.

Slowly turn the main fuel needle (see Figure 5-1C) in clockwise direction until the engine speed decreases then back it out about 1/4 turn for best high speed performance.

SECTION 5 FUEL SYSTEM AND GOVERNOR

5

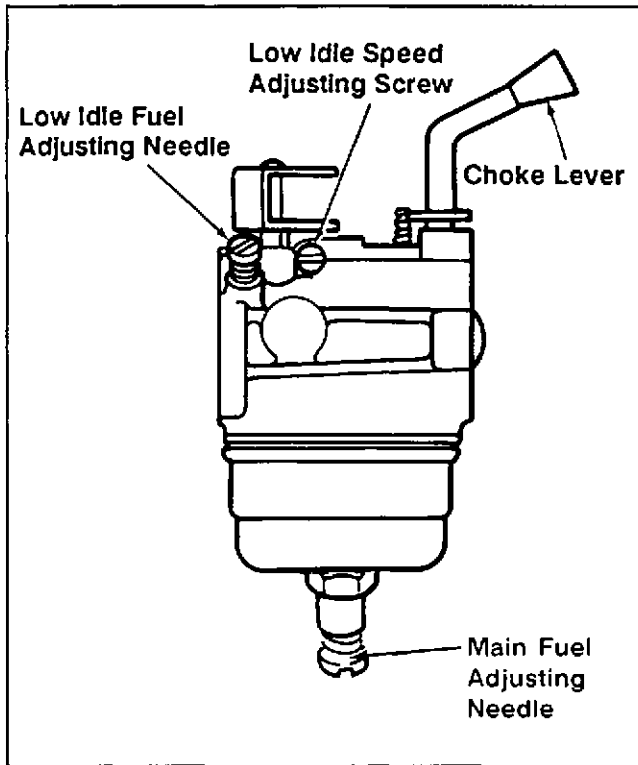

Figure 5-1C. CH6 Adjustable Main Fuel Carburetor.

5. **Low Idle Speed Setting:** Place the throttle into the "idle" or "slow" position and check RPM with a tachometer. Note that the actual low speed setting depends on the application, however, most are set at 1200 (\pm 75 RPM). Low idle speed must not exceed 1500 RPM. To adjust: turn the low idle speed adjusting screw in or out until the desired speed is attained.

NOTE: In constant speed applications, the low speed setting has no effect on operation so this final adjustment is not needed.

6. **Low Idle Fuel Setting:** Move throttle into "idle" or "slow" position then turn the low idle fuel needle out (counterclockwise) from the preliminary setting until the engine speed decreases (rich)—note position of the needle then turn it back in (clockwise) until it again increases then decreases (lean)—set the needle midway between the rich and lean settings. (See Figure 5-2.) Note: On constant speed applications, turn the low fuel adjusting needle out 1-1/4" turns from bottom and leave at this setting.

7. After adjusting, recheck low idle speed with a tachometer and reset as needed as described in Step 5.

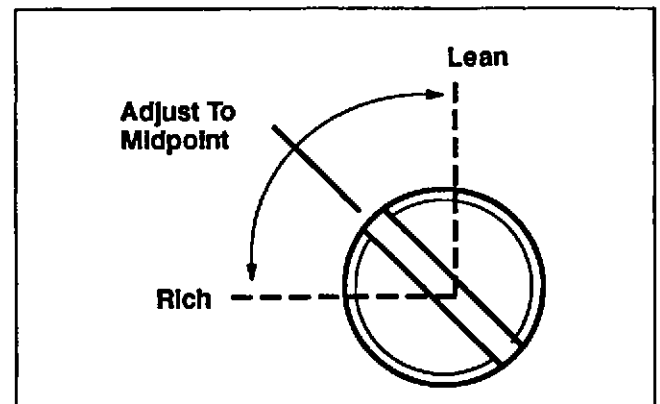

Figure 5-2. Optimum Low Idle Fuel Setting.

SECTION 5 FUEL SYSTEM AND GOVERNOR

Disassembly

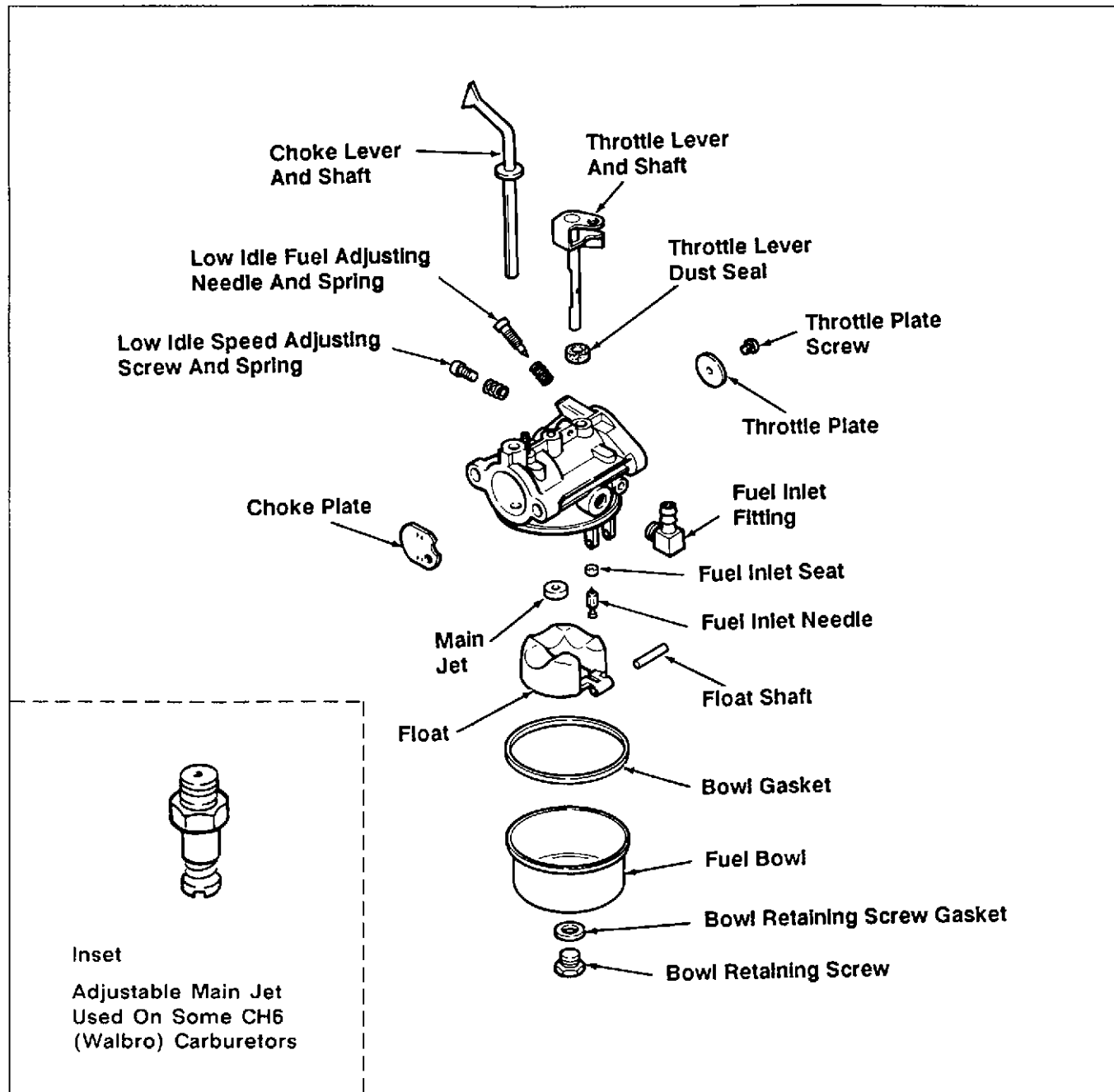

Figure 5-3A. CH5 (Walbro) Fixed Main Jet Carburetor – Exploded View.

1. Remove the bowl retaining screw, retaining screw gasket, and fuel bowl.
2. Remove the bowl gasket, float shaft, float, and fuel inlet needle.
3. Remove the low idle fuel adjusting needle and

spring. Remove the low idle speed adjusting screw and spring.

Further disassembly of the carburetor (removal of the welch plugs, fuel inlet seat, throttle plate and shaft, and choke plate and shaft) is recommended only if these parts are to be cleaned or replaced.

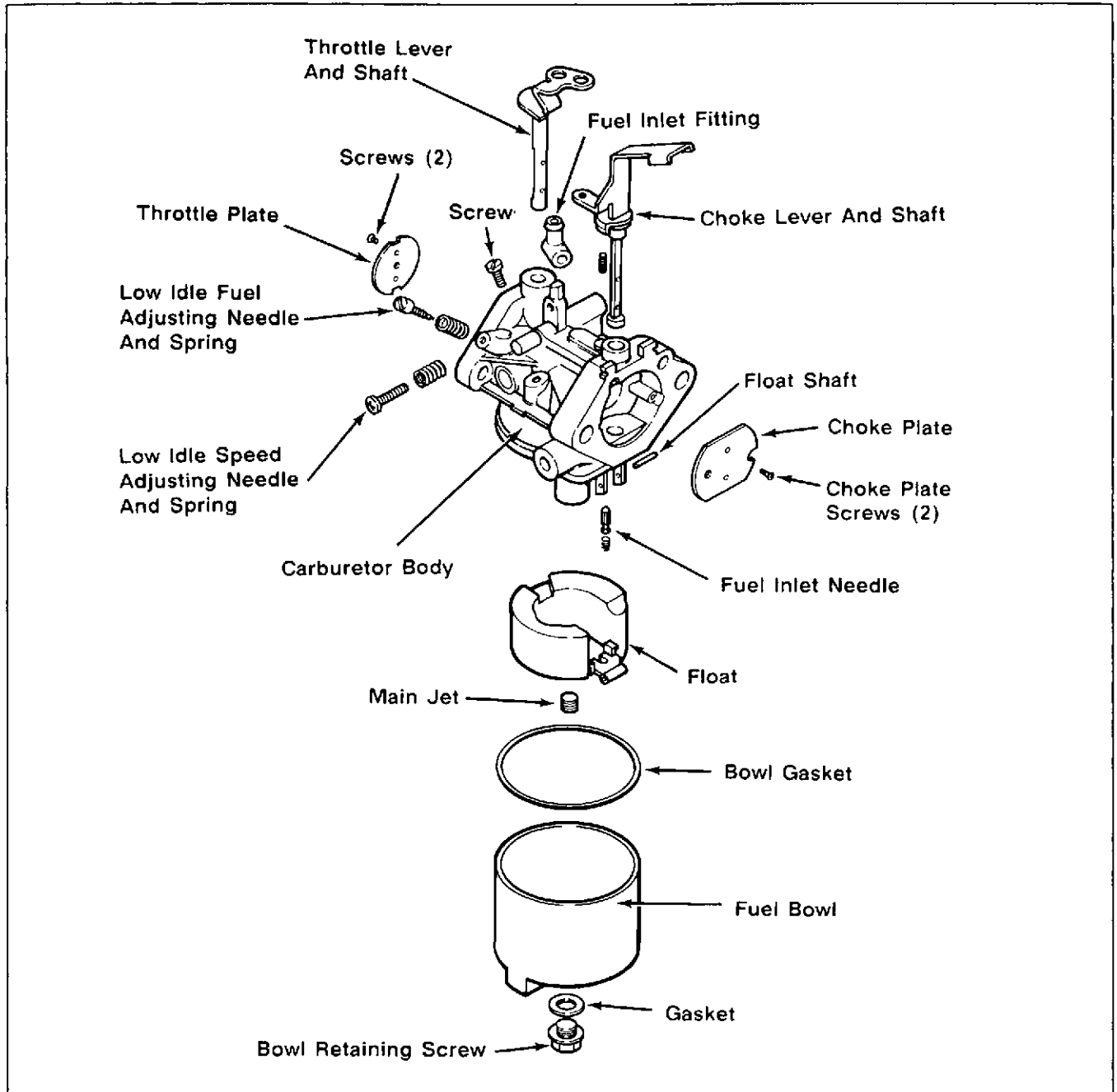

Figure 5-3B. CH6 (Keihin) Fixed Main Jet Carburetor – Exploded View.

Welch Plug Removal

In order to clean the "off-idle" ports and bowl vent thoroughly, remove the welch plugs covering these areas.

Use tool no. **KO-1018** and the following procedure to remove the welch plugs. See Figure 5-4.

SECTION 5 FUEL SYSTEM AND GOVERNOR

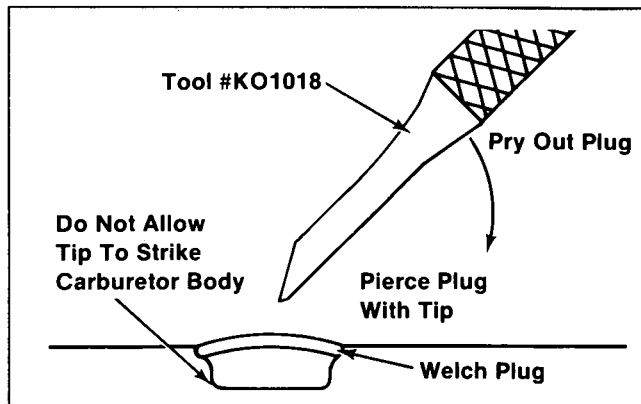

Figure 5-4. Removing Welch Plug.

1. Pierce the welch plug with the tip of the tool.

NOTE: To prevent damage to the carburetor, do not allow the tool to strike the carburetor body.

2. Pry out the welch plug with the tip of the tool.

Fuel Inlet Seat Removal

To remove the fuel inlet seat, pull it out of the carburetor body using a screw, drill bit, or similar tool.

NOTE: Always install a new fuel inlet seat. Do not reinstall a seat that has been removed.

Choke Shaft Removal

1. Because the edges of the choke plate on CH5 are beveled, mark the choke plate and carburetor body to ensure correct reassembly. See Figure 5-5.

Also take note of the choke plate position in the bore, and the position of the choke lever.

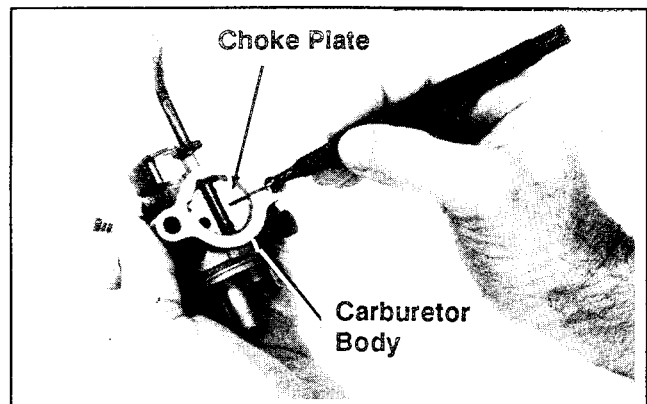

Figure 5-5. Marking Choke Plate And Carburetor Body.

2. Grasp the choke plate with a pliers. Pull it out of the slot in the choke shaft. See Figure 5-6. The choke plate on CH6 is secured with two screws – remove the screws and choke plate.

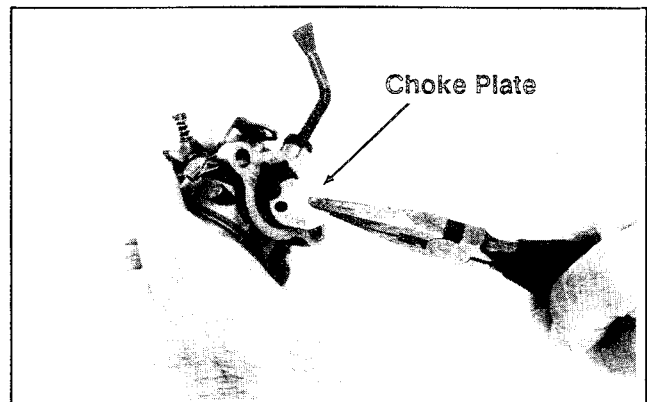

Figure 5-6. Removing Choke Plate.

3. Remove the choke shaft.

Throttle Shaft Removal

1. Because the edges of the throttle plate are beveled on CH5 models, mark the throttle plate and carburetor body to ensure correct reassembly.

Also take note of the throttle plate position in the bore, and the position of the throttle lever on CH5.

2. Carefully and slowly remove the screw (screws on CH6), which secures the throttle plate to the throttle shaft. Remove the throttle plate.
3. File off any burrs which may have been left on the throttle shaft when the screw was removed. Do

this **before** removing the throttle shaft from the carburetor body.

4. Remove the throttle lever/shaft assembly with the foam dust seal.

Cleaning



WARNING: Flammable Solvents!

Carburetor cleaners and solvents are extremely flammable. Keep sparks, flames, and other sources of ignition away from the area. Follow the cleaner manufacturer's warnings and instructions on its proper and safe use. Never use gasoline as a cleaning agent.

All parts should be cleaned thoroughly using a carburetor cleaner (such as acetone). **Make sure** all gum deposits are removed from the following areas:

- **Carburetor body and bore;** especially the areas where the throttle plate, choke plate and shafts are seated.
- **Idle fuel and "off-idle" ports in carburetor bore, main jet, bowl vent, and fuel inlet needle and seat.**

NOTE: These areas can be cleaned with a piece of fine wire in addition to cleaners. Be careful not to enlarge the ports, or break the wire inside the ports. Wearing proper eye protection, blow out all passages with compressed air.

- **Float and float hinge.**
- **Fuel bowl.**
- **Throttle plate, choke plate, throttle shaft, and choke shaft.**

NOTE: Do not submerge the carburetor in cleaner or solvent when fiber, rubber, or foam seals or gaskets are installed. The cleaner may damage these components.

Inspection

Carefully inspect all components and replace those that are worn or damaged.

- Inspect the carburetor body for cracks, holes, and other wear or damage.
- Inspect the float for cracks, holes, and missing or damaged float tabs. Check the float hinge and shaft for wear or damage.
- Inspect the fuel inlet needle and seat for wear or damage.
- Inspect the tip of the low idle fuel adjusting needle for wear or grooves.
- Inspect the throttle and choke shaft and plate assemblies for wear or excessive play.

Repair

Always use new gaskets when servicing or reinstalling carburetors. Repair kits are available which include new gaskets and other components.

Components such as the throttle and choke shaft assemblies, throttle plate, choke plate, low idle fuel needle, and others are available separately.

Always refer to the Parts Manual for the engine being serviced to ensure the correct repair kits and replacement parts are ordered.

Reassembly

Throttle Shaft Installation

1. Install the foam dust seal on the throttle shaft.
2. Insert the throttle lever/shaft assembly into the carburetor body. Position the cutout portion of the shaft so it faces the carburetor mounting flange.
3. Install the throttle plate to the throttle shaft. Make sure the plate is positioned properly in the bore as noted and marked during disassembly. Apply Loctite® no. 609 to the threads of the throttle plate retaining screw. Install the screw so that it is slightly loose.

SECTION 5

FUEL SYSTEM AND GOVERNOR

4. Apply finger pressure to the throttle lever/shaft to keep it firmly seated against the pivot in the carburetor body. Rotate the throttle shaft until the throttle plate closes the bore around its entire perimeter; then tighten the screw(s). See Figure 5-7.

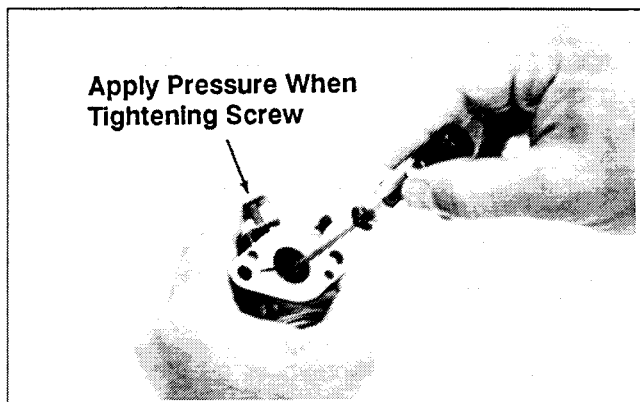

Figure 5-7. Installing The Throttle Lever/Shaft.

5. Operate the throttle lever. Check for binding between the throttle plate and carburetor bore. Loosen the screw and adjust the throttle plate as necessary.

Torque the screw(s) to **0.9 – 1.4 N·m**
(**8 – 12 in. lb.**).

Choke Shaft Installation (CH5 Models)

1. Insert the choke shaft into the carburetor body until the choke shaft detent collar touches the top of the detent spring on the carburetor.
2. Lift the detent spring away from the choke shaft detent collar using a small screwdriver, and insert the choke shaft further into the carburetor body until it bottoms. Spring should now engage with detents of collar.
3. Position the choke lever as noted during disassembly (choke lever should point to the left when viewed from the choke side of the carburetor).
4. Position the choke plate as noted and marked during disassembly. Insert the choke plate into the slot in the choke shaft. Make sure that the choke plate is inserted far enough that its locking tabs are positioned on each side of the choke shaft.

Fuel Inlet Seat Installation

Press the fuel inlet seat into the bore in the carburetor body until it bottoms.

Welch Plug Installation

Use tool no. **KO-1017** and install new plugs as follows:

1. Position the carburetor body with the welch plug cavities to the top.
2. Place a new welch plug into the cavity with the raised surface **up**.
3. Use the end of the tool that is about the same size as the plug and **flatten** the plug. Do not force the plug below the surface of the cavity. See Figure 5-8.

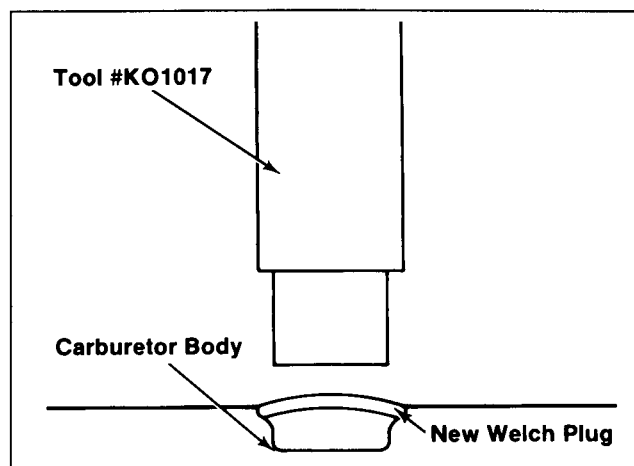

Figure 5-8. Installing Welch Plugs.

4. After the plugs are installed, seal them with fingernail polish or lacquer (or an equivalent sealant). Allow the sealant to dry completely.

Carburetor Reassembly

1. Install the low idle speed adjusting screw and spring.
2. Install the low idle fuel adjusting needle and spring. Turn the adjusting needle **in** (clockwise) until it bottoms *lightly*.

NOTE: The tip of the idle fuel adjusting needle is tapered to critical dimensions. Damage to the needle and the seat in the carburetor body will result if the needle is forced.

3. Turn the low idle fuel adjusting needle **out** (counterclockwise) **1 full turn** from lightly bottomed.

NOTE: After installation of the reassembled carburetor, follow the final adjustment procedures listed in Steps 3, 4, 5, and 6 of "Adjustment" (in this Section).

4. Insert the fuel inlet needle into the float. Lower the float/needle into the carburetor body. See Figure 5-9.

Install the float shaft.

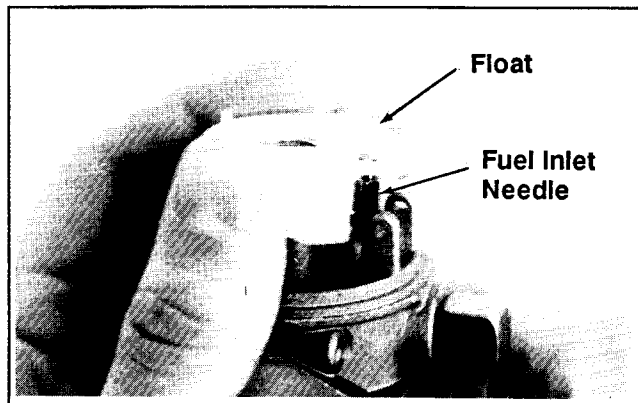

Figure 5-9. Installing Float And Fuel Inlet Needle.

5. Install the bowl gasket, fuel bowl, bowl retaining screw gasket, and bowl retaining screw.

Torque the bowl retaining screw to **9.8 N•m (87 in. lb.)**.

GOVERNOR

These engines are equipped with centrifugal flyweight type mechanical governors. The governor is designed to hold the engine speed constant under changing load conditions. The governor gear/flyweight mechanism is mounted inside the crankcase and is driven off the gear on the camshaft. See Figure 5-10 (camshaft gear removed for clarity of photograph).

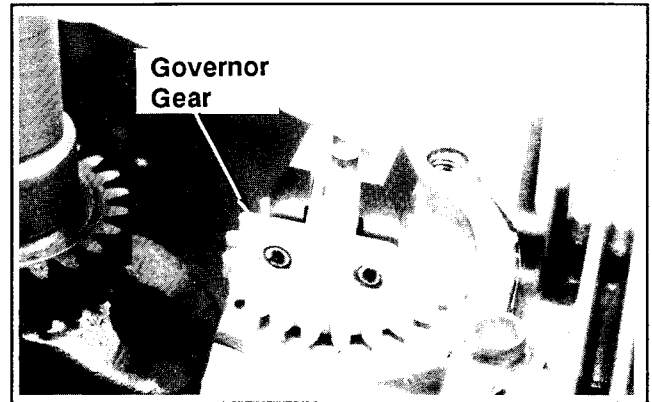

Figure 5-10. Governor Gear Assembly.

Operation

Centrifugal force acting on the rotating governor gear assembly causes the flyweights to move outward as speed increases, and inward as speed decreases. As the flyweights move outward, they cause the regulating pin to extend from the governor gear assembly.

The regulating pin contacts the tab on the cross shaft, causing the shaft to rotate when the engine speed changes. See Figure 5-11. One end of the cross shaft protrudes through the side of the closure plate. Through external linkage attached to the cross shaft, the rotating action is transmitted to the throttle lever of the carburetor.

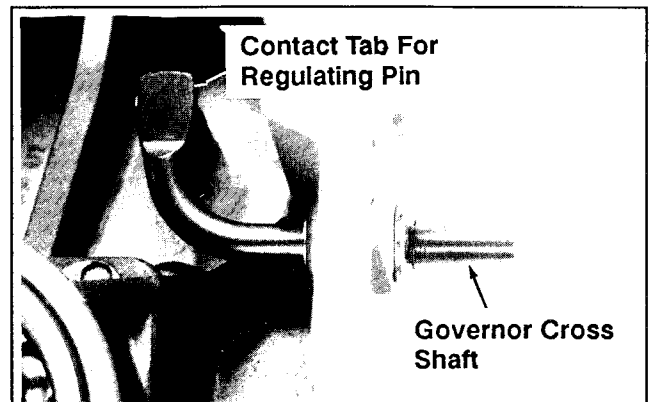

Figure 5-11. Governor Cross Shaft.

When the engine is at rest, and the throttle control is in the "fast" position, the tension of the governor spring holds the throttle plate open. When the engine is operating (the governor gear assembly is rotating), the force applied by the regulating pin against the cross shaft tends to close the throttle plate. The governor

SECTION 5

FUEL SYSTEM AND GOVERNOR

spring tension and the force applied by the regulating pin are in "equilibrium" during operation, holding the engine speed constant.

When load is applied and the engine speed (and governor gear speed) decreases, the governor spring tension moves the governor lever to open the throttle plate wider. This allows more fuel into the engine; increasing engine speed. (This action occurs very rapidly, so a reduction in speed is hardly noticed.) As the speed reaches the governed setting, the governor spring tension and the force applied by the regulating pin will again be in equilibrium. This maintains the engine speed at a relatively constant level.

The governed speed setting is determined by the position of the throttle control. It can be variable or constant, depending on the application.

Initial Adjustment

Make this initial adjustment whenever the governor lever is loosened or removed from the cross shaft. To ensure proper setting, make sure the throttle linkage is connected to the governor lever and to the carburetor throttle lever. See Figure 5-12 (certain engine components removed for clarity of photograph).

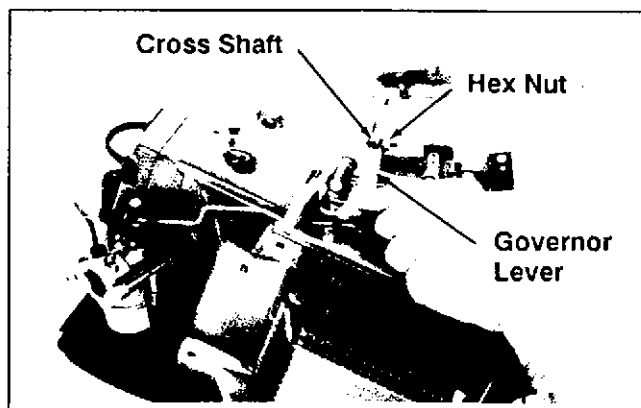

Figure 5-12. Initial Governor Adjustment.
(CH5 Shown)

1. Loosen the governor lever hex. nut.
2. Pull and hold the governor lever away from the carburetor so that the carburetor throttle plate is in the "wide open throttle" position.

3. Grasp the governor cross shaft with a pliers and turn the shaft **counterclockwise** as far as it will go.
4. Tighten the hex. nut securely.

High Idle Speed Adjustment

The recommended maximum no-load high idle speed for most of these engines is **3750 rpm**. The actual high idle speed depends on the application. Refer to the equipment manufacturer's instructions for specific information.

⚠ WARNING: Overspeed is Hazardous!
Do not tamper with the the governor setting. Overspeed is hazardous and could cause personal injury.

The high idle speed is set by turning the high idle speed adjusting screw on the high idle speed/kill switch bracket assembly **in or out**. See Figure 5-13 and follow the procedures listed below:

NOTE: Although certain engine components have been removed for clarity of the photograph, never run the engine with the air cleaner assembly removed. Damage to the engine will result due to unfiltered air entering.

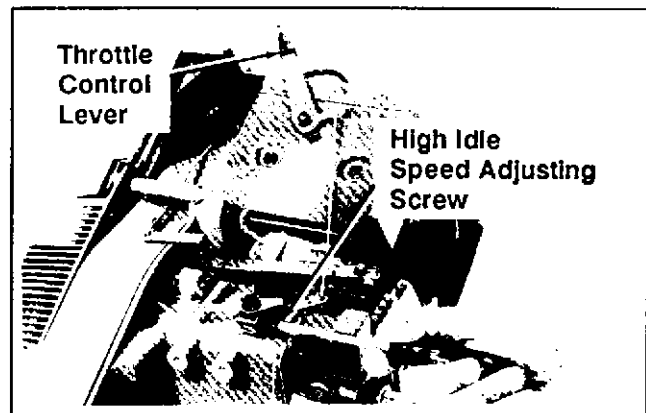

Figure 5-13A. High Idle Speed/Kill Switch Bracket Assembly On CH5.

1. Start the engine and allow it to warm up. Place the throttle control lever into the "fast" or high idle position.
2. Check the engine speed with a tachometer.

3. **To increase the high idle speed** – turn the high idle speed adjusting screw **out** (counterclockwise), while applying light pressure to (and thereby gradually moving) the throttle control lever in the high idle speed direction (toward the carburetor), until the desired engine speed is attained.

To decrease the high idle speed – turn the high idle speed adjusting screw **in** (clockwise), until the desired engine speed is attained.

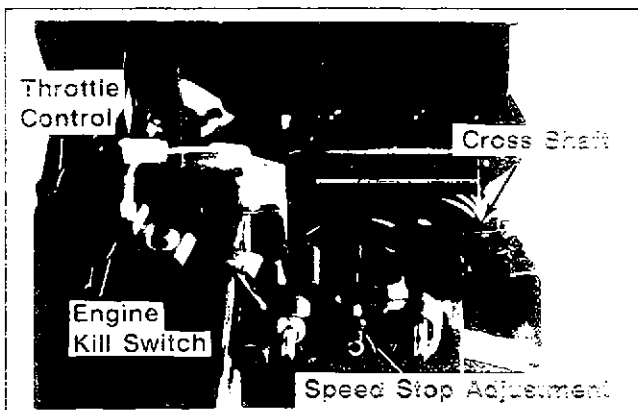

Figure 5-13B. Governor Components On CH6 Model.

Low Idle Speed Adjustment

The low idle speed is set by turning the low idle speed adjusting screw on the carburetor **in or out**. This setting must be made in conjunction with the low idle fuel mixture setting. Refer to "Carburetor" earlier in this Section.

Sensitivity Adjustment

Governor sensitivity is adjusted by repositioning the governor spring in the holes in the governor lever. If speed surging occurs with a change in load, the governor is set too sensitive. If a big drop in speed occurs when normal load is applied, the governor should be set for greater sensitivity.

The governor lever has five holes for use in adjusting governor sensitivity. See Figure 5-14. For the least governor sensitivity, the governor spring should be inserted in the lever hole closest to the governor cross shaft. The lever holes become increasingly sensitive the farther they are from the cross shaft. For the greatest governor sensitivity, the governor spring should be inserted in the lever hole farthest from the governor cross shaft.

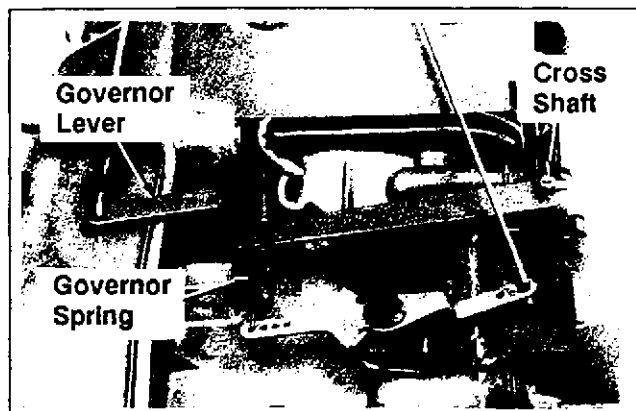

Figure 5-14. Governor Sensitivity Adjustment.

5

CONSTANT SPEED VARIATION

While most CH5 and CH6 engines have variable speed governors as described and shown in the foregoing, certain CH6 models are equipped with constant speed governor control. On these, the engine comes up to top governed speed immediately after starting. They do not have throttle control lever or engine kill switch on the governor high speed bracket. Stopping these is accomplished by depressing and holding a spring steel "kill" lever against the spark plug. Governor sensitivity is adjusted the same as described above for the variable speed type governors. High idle governed speed can be adjusted by turning the high speed stop screw in or out as shown in Figure 5-15.

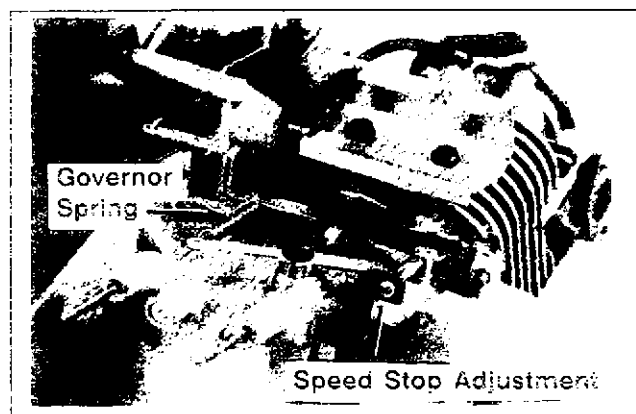

Figure 5-15. Constant Speed Governor Variation (CH6).

SECTION 6

LUBRICATION SYSTEM

OIL RECOMMENDATIONS

Using the proper type and weight of oil in the crankcase is extremely important. So is checking oil daily and changing oil regularly. Failure to use the correct oil, or using dirty oil, causes premature engine wear and failure.

Oil Type

Use high-quality detergent oil of **API (American Petroleum Institute) service class SF or SG**. Select the viscosity based on the air temperature at the time of operation as shown in the following table.

Recommended SAE Viscosity Grades

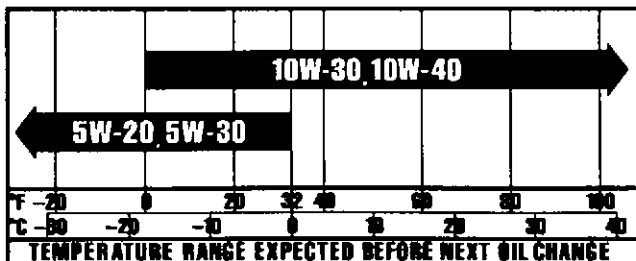

NOTE: Using other than service class SF or SG oil or extending oil change intervals longer than recommended can cause engine damage.

A logo or symbol on oil containers identifies the API service class and SAE viscosity grade. See Figure 6-1.



Figure 6-1. Oil Container Logo.

6

CHECK OIL LEVEL

The importance of checking and maintaining the proper oil level in the crankcase cannot be overemphasized. Check oil **BEFORE EACH USE** as follows:

For CH5 Engines With Extended Oil Fill Tube/Dipstick

1. Make sure the engine is stopped, level, and is cool so the oil has had time to drain into the sump.
2. To keep dirt, grass clippings, etc., out of the engine, clean the area around the oil fill cap/dipstick before removing it.
3. Unthread and remove the oil fill cap/dipstick; wipe oil off. Reinsert the dipstick into the tube and rest the oil fill cap on the tube. Do not thread the cap onto the tube. See Figure 6-2.

SECTION 6 LUBRICATION SYSTEM

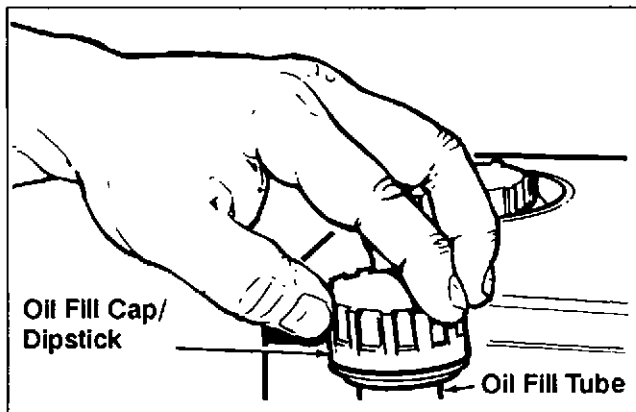

Figure 6-2. Checking Oil Level – CH5 Engines With Extended Oil Fill Tube/Dipstick.

4. Remove the dipstick and check the oil level.

The oil level should be up to, but not over, the “F” mark on the dipstick. See Figure 6-3.

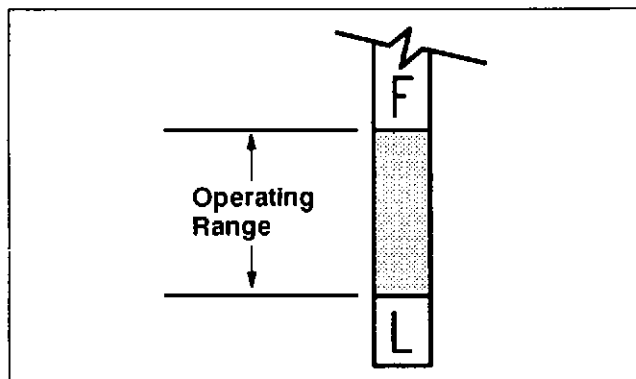

Figure 6-3. Oil Level Dipstick On CH5.

5. If the level is low, add oil of the proper type, up to the “F” mark on the dipstick. Refer to “Oil Type” in this Section. Always check the level with the dipstick before adding more oil.

NOTE: To prevent extensive engine wear or damage, always maintain the proper oil level in the crankcase. Never operate the engine with the oil level below the “L” mark or over the “F” mark on the dipstick.

For CH6 Engines With Oil Fill/Check Plug

1. Make sure the engine is stopped, level and is cool so the oil has time to drain into the sump.

2. To keep dirt, grass clippings, etc., out of the engine, clean the areas around the oil fill/check plug and filler neck.
3. Unthread and remove the oil fill/check plug from the filler neck. When full, the oil level will be up to the point of overflowing the filler neck. If you can see some oil in the sump, this may be too low.
4. If the level is low, bring it up to the point of overflowing the filler neck as shown in Figure 6-4. Refer to “OIL TYPE” on page 6.1 for correct type of oil to use.

NOTE: To prevent extensive engine wear or damage, always maintain the proper oil level in the crankcase. Never operate a CH5 engine with the oil level below the point of overflowing the filler neck.

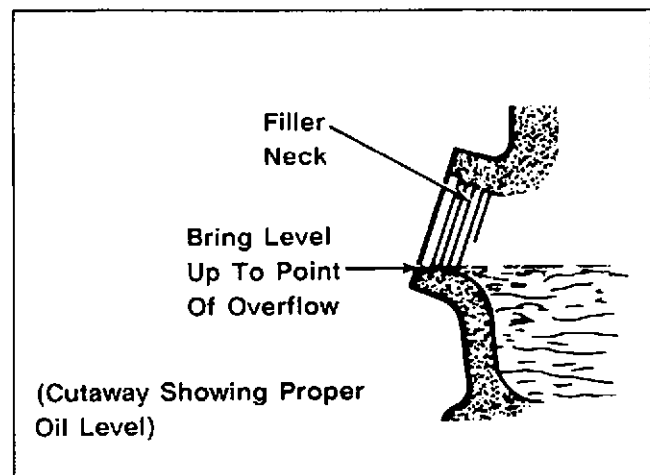

Figure 6-4. Proper Oil Level On CH6 Engine.

Oil Sentry™

Some engines are equipped with an optional Oil Sentry oil level monitor. If the oil level gets low, Oil Sentry will either shut off the engine or activate a warning signal, depending on the application.

NOTE: Make sure the oil level is checked **BEFORE EACH USE** and is maintained up to the “F” mark on the dipstick on CH5 engines or to the point of overflowing the filler neck on CH6 engines. This includes engines equipped with Oil Sentry.

CHANGE OIL

For a new engine, change oil after the first 5 hours of operation. Thereafter, change oil after every 100 hours of operation.

For an overhauled engine or those rebuilt with a new short block, use 10W-30-weight service class SF or SG oil for the first 5 hours of operation. Change the oil after this initial run-in period. Refill with service class SF or SG oil as specified in the "Viscosity Grades" table in this Section.

Change the oil while the engine is still warm. The oil will flow freely and carry away more impurities. Make sure the engine is level when filling/checking the oil.

Change the oil as follows (see Figure 6-5):

1. Remove the oil drain plug and oil fill cap/dipstick or oil fill/check plug on CH6 engines. Be sure to allow ample time for complete drainage. Tip engine if possible to speed draining.
2. Reinstall the drain plug. Make sure it is tightened to 17.6 N•m (13 ft. lb.) torque.
3. Fill the crankcase, with new oil of the proper type, to the "F" mark on the dipstick or to the point of overflowing the filler neck on CH6 engines. Refer to "Oil Type" in this Section. Always check the level before adding more oil.
4. Reinstall the oil fill cap/dipstick and tighten securely.

NOTE: To prevent extensive engine wear or damage, always maintain the proper oil level in the crankcase. Never operate the engine with the oil level below the "L" mark or over the "F" mark on the dipstick on CH5 engines or when the level falls below the point of overflowing the filler neck on CH6 engines.

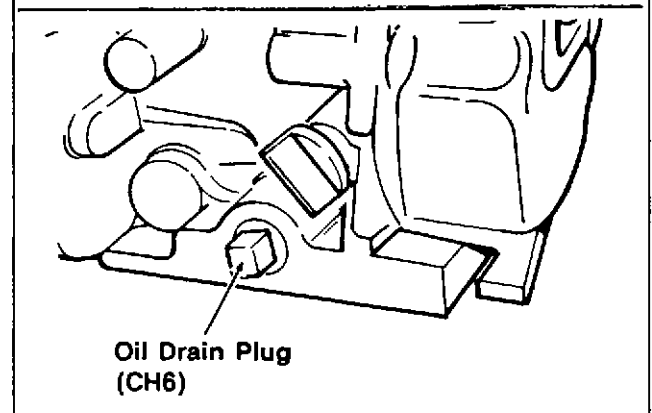
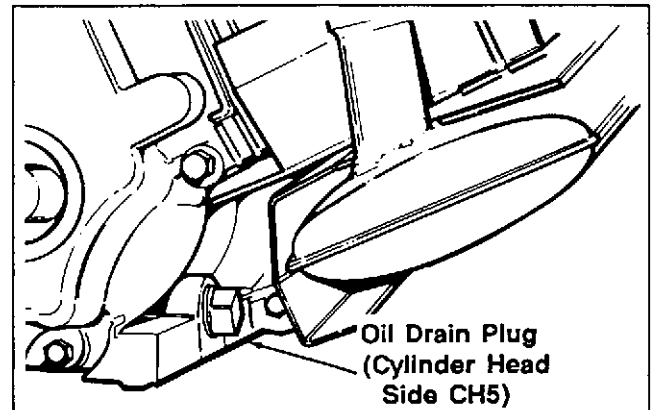
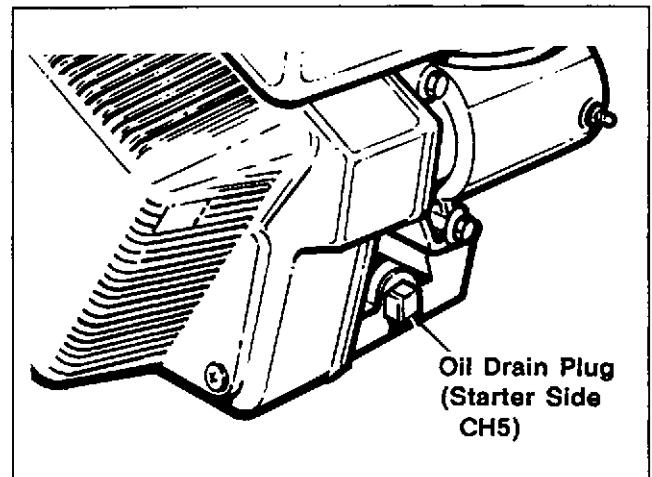

Figure 6-5. Oil Drain Plugs.

*NOTE: This side often used for the optional Oil Sentry™ Switch (in place of the oil drain).

SECTION 7 RETRACTABLE STARTER



CAUTION: Spring Under Tension!

Retractable starters contain a powerful, flat wire recoil spring that is under tension. Do not remove the center screw from the starter until the spring tension is released. Removing the center screw before releasing spring tension, or improper starter disassembly, can cause the sudden and potentially dangerous release of the spring.

Always wear safety goggles when servicing retractable starters – full face protection is recommended.

To ensure personal safety, and proper starter disassembly and reassembly, follow the procedures in this section carefully.

7

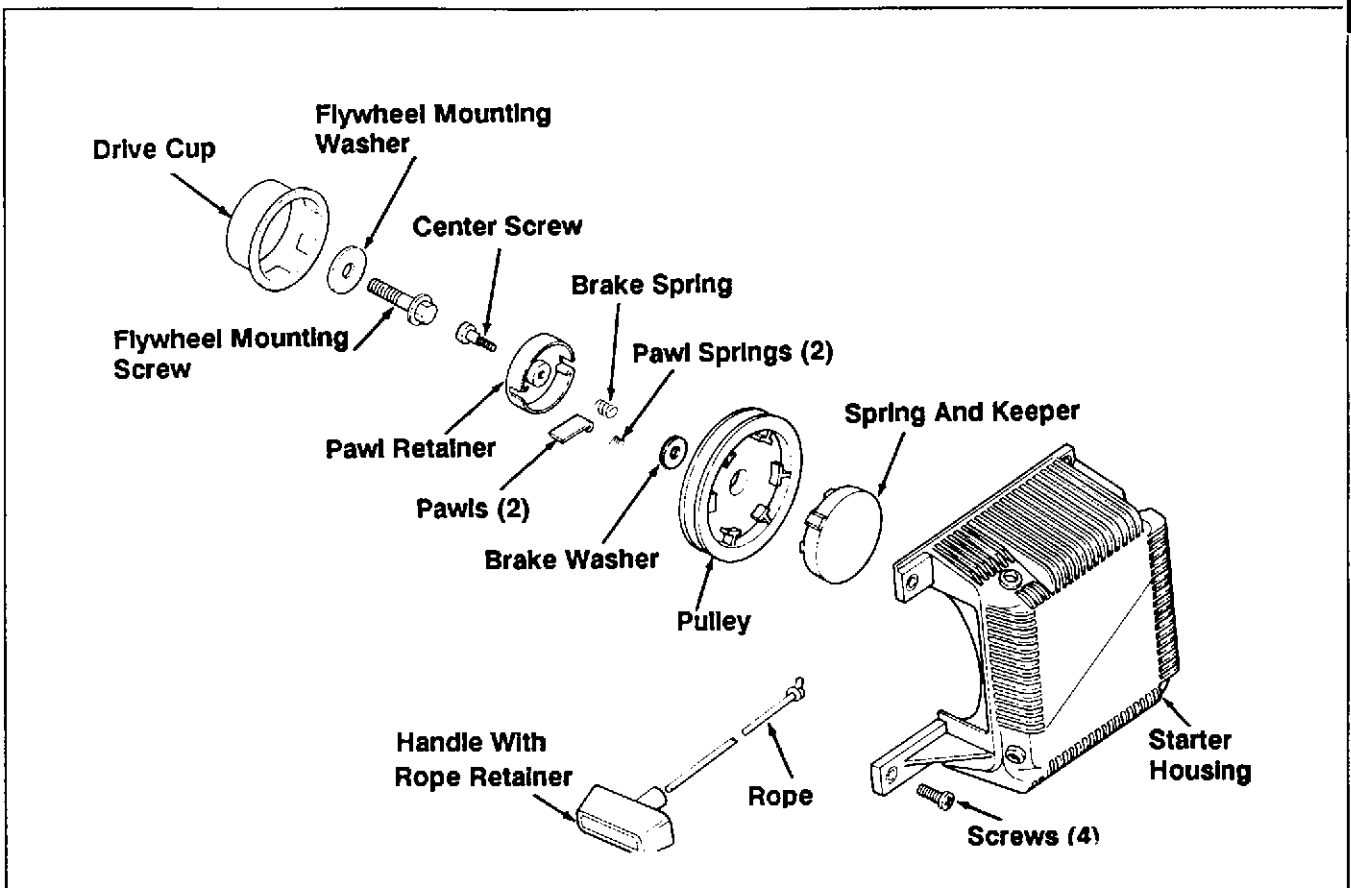

Figure 7-1. Retractable Starter – Exploded View.

SECTION 7

RETRACTABLE STARTER

TO REMOVE STARTER

1. Remove air cleaner cover. See "Service Precleaner", Step 1 and Figures 4A-1 and 4B-1 in Sections 4A and 4B "AIR CLEANER & AIR INTAKE SYSTEM".
2. Remove the four hex. flange screws securing the starter to blower housing.
3. Remove the starter.

TO INSTALL STARTER

1. Install the retractable starter and four hex. flange screws to blower housing. Leave the screws slightly loose.
2. Pull the starter handle out until the pawls engage in the drive cup. Hold the handle in this position and tighten the screws securely. See Figure 7-2.
3. Install the air cleaner cover.



Figure 7-2. Installing Retractable Starter.

ROPE REPLACEMENT

The rope can be replaced *without* complete starter disassembly.

1. Remove the starter from the engine blower housing.
2. Pull the rope out approx. 12" and tie a temporary (slip) knot in it to keep it from retracting into the starter. See Figure 7-3.

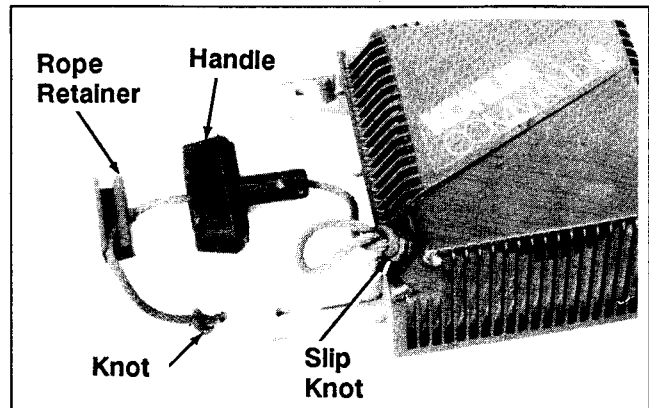

Figure 7-3. Removing Starter Handle.

3. Remove the rope retainer from inside the starter handle. Untie the single knot and remove the rope retainer and handle.
4. Hold the pulley firmly and untie the slip knot. Allow the pulley to rotate slowly as the spring tension is released.
5. When all spring tension on the starter pulley is released, remove the rope from pulley.
6. Tie a single knot in one end of the new rope.
7. Rotate the pulley counterclockwise (when viewed from pawl side of pulley) until the spring is tight. (Approx. 5 full turns of pulley.)
8. Rotate the pulley clockwise until the rope hole in pulley is aligned with rope guide bushing of starter housing.

NOTE: Do not allow the pulley/spring to unwind. Enlist the aid of a helper if necessary, or use a C-clamp to hold the pulley in position.

9. Insert the new rope through the rope hole in starter pulley and rope guide bushing of housing. See Figure 7-4.

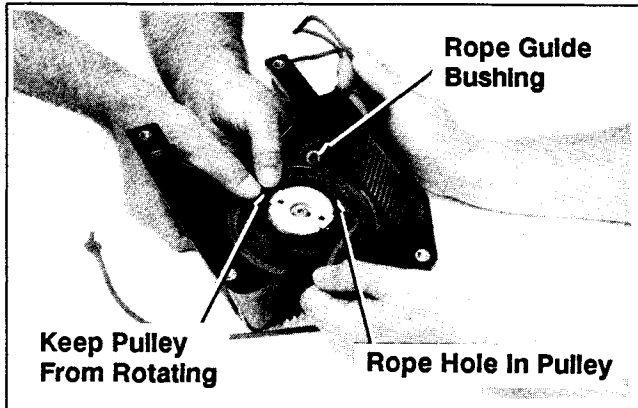

Figure 7-4. Installing Rope.

10. Tie a slip knot approx. 12" from the free end of rope. Hold the pulley firmly and allow it to rotate slowly until the slip knot reaches the guide bushing of housing.
11. Slip the handle and rope retainer onto the rope. Tie a single knot at the end of the rope. Install the rope retainer into the starter handle.
12. Untie the slip knot and pull on the handle until the rope is fully extended. Slowly retract the rope into the starter.

When the spring is properly tensioned, the rope will retract fully and the handle will stop against the starter housing.

PAWLS (DOGS) REPLACEMENT

The starter must be completely disassembled to replace the starter pawls. A pawl repair kit is available which includes the following components:

Pawl Repair Kit 15 757 01 Contains:

Qty.	Description
1	Pawl Retainer
1	Center Screw
2	Pawl (Dog) Spring
1	Brake Spring
2	Starter Pawl (Dog)
1	Brake Washer

DISASSEMBLY



CAUTION: Spring Under Tension!

Do not remove the center screw from starter until the spring tension is released. Removing the center screw before releasing spring tension, or improper starter disassembly, can cause the sudden and potentially dangerous release of the spring. Follow these instructions carefully to ensure personal safety and proper starter disassembly. Make sure adequate face protection is worn by all persons in the area.

1. Release spring tension and remove the handle and starter rope. (Refer to "Rope Replacement", Steps 2 through 5 above.)
2. Remove the center screw and pawl retainer. See Figure 7-5.
3. Remove the brake spring and brake washer. See Figure 7-6.
4. Carefully note the positions of the pawls and pawl springs before removing them.

Remove the pawls and pawl springs from the starter pulley.

SECTION 7 RETRACTABLE STARTER

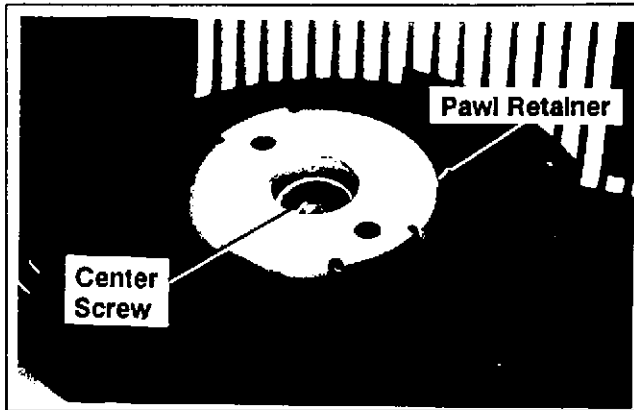

Figure 7-5. Center Screw And Pawl Retainer.

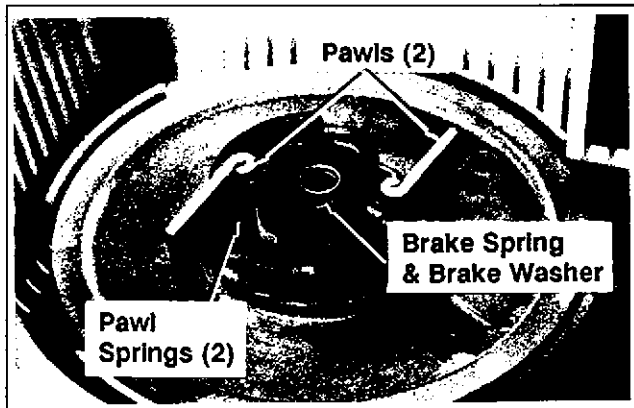

Figure 7-6. Brake Spring And Washer, Pawls, And Pawl Springs.

5. Rotate the pulley **clockwise 2 full turns**. This will ensure the spring is disengaged from the starter housing.
6. Hold the pulley into the starter housing. Invert the pulley/housing so the pulley is away from your face, and away from others in the area.
7. Rotate the pulley slightly from side to side and carefully separate the pulley from the housing. See Figure 7-7.

If the pulley and the housing do not separate easily, the spring could be engaged in the starter housing, or there is still tension on the spring. Return the pulley to the housing and repeat step 5 before separating the pulley and housing.

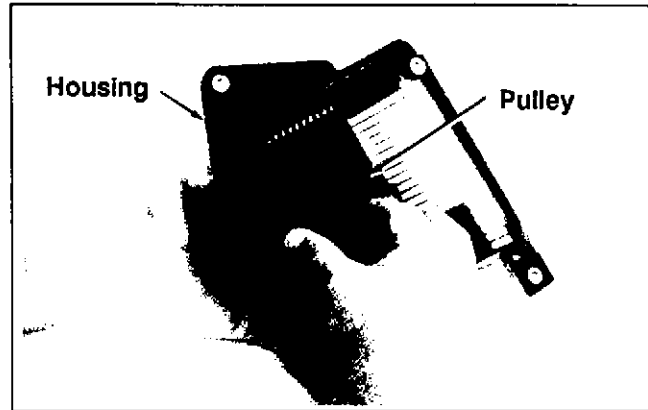

Figure 7-7. Removing Pulley From Housing.

8. Note the position of the spring and keeper assembly in the pulley. See Figure 7-8.

Remove the spring and keeper assembly from the pulley as a package.



CAUTION: Spring Under Tension!

Do not remove the spring from the keeper. Severe personal injury could result from the sudden uncoiling of the spring.

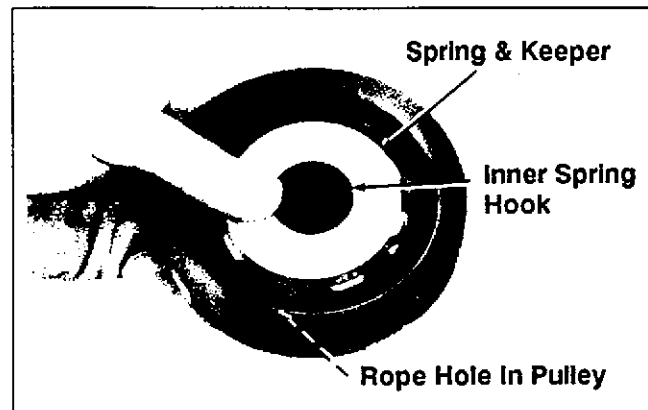

Figure 7-8. Position Of Spring And Keeper In Pulley.

INSPECTION AND SERVICE

1. Carefully inspect the rope, pawls, housing, center screw, and other components for wear or damage.
2. Replace all worn or damaged components. Use only genuine Kohler replacement parts as specified in the Parts Manual. All components shown in Figure 7-1 are available as service parts. Do not use nonstandard parts.

3. Do not attempt to rewind a spring that has come out of the keeper. Order and install a new spring and keeper assembly.
4. Clean all old grease and dirt from the starter components. Generously lubricate the spring and center shaft with any commercially-available bearing grease.

REASSEMBLY

1. Make sure the spring is well-lubricated with grease. Place the spring and keeper assembly inside the pulley (with spring towards pulley). See Figure 7-8.
2. Install the pulley with spring and keeper assembly into the starter housing. See Figure 7-9.

Make sure the pulley is fully seated against the starter housing. Do not wind the pulley and recoil spring at this time.

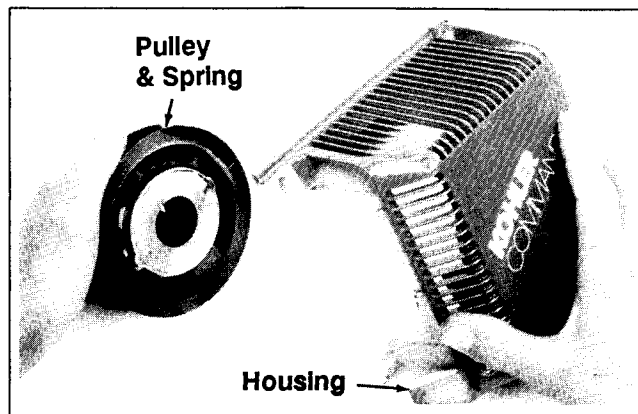

Figure 7-9. Installing Pulley And Spring Into Housing.

3. Install the pawl springs and pawls into the starter pulley. See Figure 7-10.

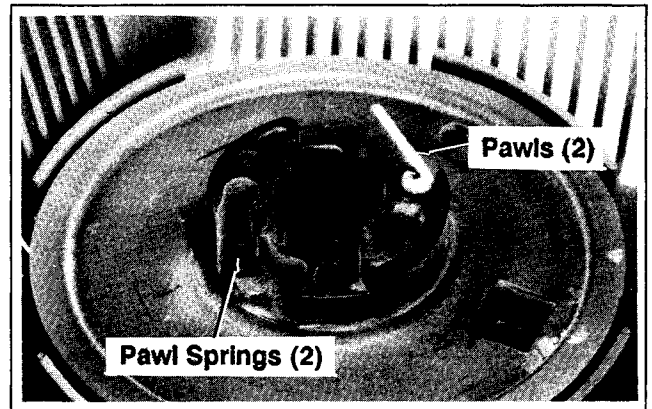

Figure 7-10. Installing Pawls And Pawl Springs.

4. Place the brake washer in the recess in the starter housing hub.
5. Lubricate the brake spring sparingly with grease. Place the spring on the plain washer. (Make sure the threads in center shaft remain clean, dry, and free of grease and oil.)
6. Apply a small amount of **Loctite® #271** to the threads of the center screw. Install the center screw, with retainer, to the center shaft. Torque the screw to **7.4–8.5 N•m (65–75 in. lb.)**.
7. Tension the spring and install the rope and handle as instructed in Steps 6 through 12 under “Rope Replacement” above.
8. Install the starter to the engine blower housing.

SECTION 8

ELECTRICAL SYSTEM AND COMPONENTS

This Section covers the operation, service, and repair of the electrical system and electrical system components.

Major electrical systems and components covered in this Section include the spark plug, ignition system and ignition module; in addition to the following optional electrical systems and components: battery, battery charging system, electric starter, and Oil Sentry™ oil level monitor.

SPARK PLUG

Engine misfire or starting problems are often caused by a spark plug that is in poor condition or with an improper gap setting.

This engine is equipped with the following spark plug:

Type:	Champion® RC12YC (or equivalent)
Gap:	1.02 mm (0.040 in.)
Thread Size:	14 mm
Reach:	19.1 mm (3/4 in.)
Hex Size:	15.9 mm (5/8 in.)

Spark Plug Service

Every **100 hours** of operation, remove the spark plug, check its condition, and reset the gap or replace with a new plug as necessary.

1. Before removing the spark plug, clean the area around the base of the plug to keep dirt and debris out of the engine.
2. Remove the plug and check its condition. Replace the plug if worn or if reuse is questionable.

NOTE: Do not clean the spark plug in a machine which uses abrasive grit. Some grit could remain on the spark plug and enter the engine, causing extensive wear and damage.

3. Check the gap using a wire feeler gauge. Adjust the gap to **1.02 mm (0.040 in.)** by carefully bending the ground electrode. See Figure 8-1.
4. Reinstall the spark plug into the cylinder head. Torque the spark plug to **24.4 – 29.8 N·m (18 – 22 ft. lb.)**.

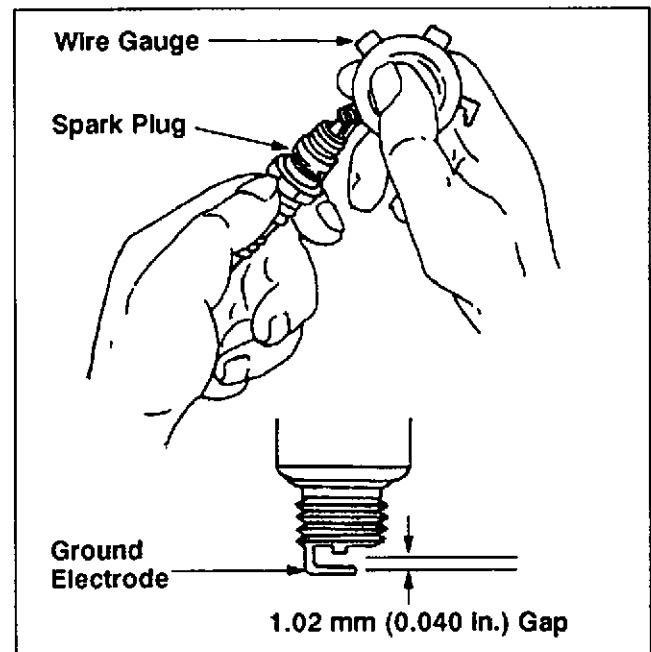

Figure 8-1. Servicing Spark Plug.

SECTION 8 ELECTRICAL SYSTEM AND COMPONENTS

Inspection

Inspect the spark plug as soon as it is removed from the cylinder head. The deposits on the tip are an indication of the general condition of the piston rings, valves, and carburetor.

Normal and fouled plugs are shown in the following photos.



Normal: A plug taken from an engine operating under normal conditions will have light tan or gray colored deposits. If the center electrode is not worn, a plug in this condition could be regapped and reused.

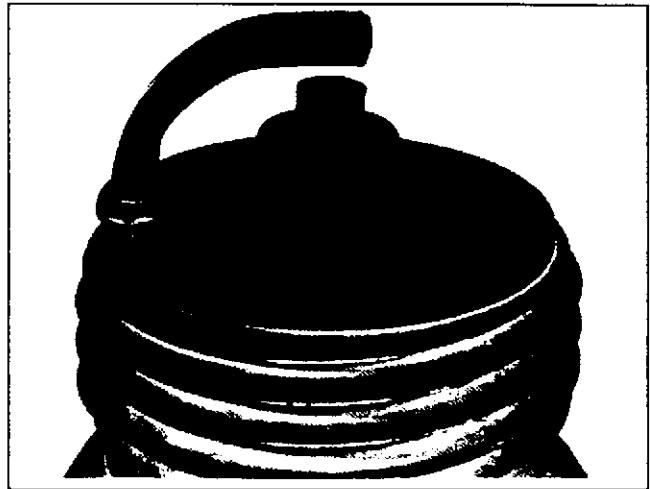

Carbon Fouled: Soft, sooty, black deposits indicate incomplete combustion. Incomplete combustion is usually caused by overrich carburetion, weak ignition, or poor compression.



Worn: On a worn plug, the center electrode will be rounded and the gap will be eroded .010" or more than the correct gap. Replace a worn spark plug immediately.

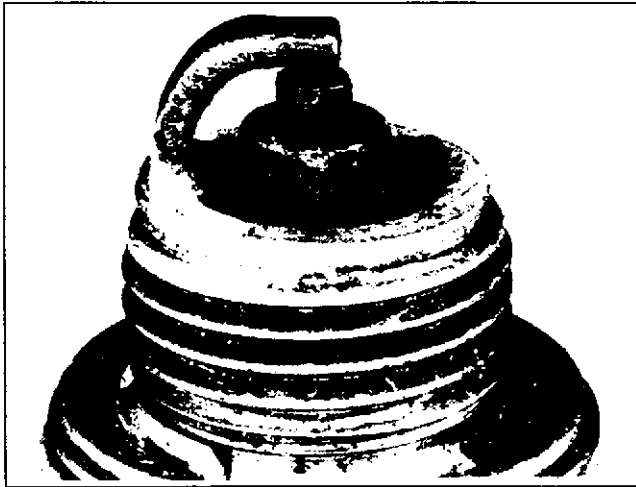

Wet Fouled: A wet plug is caused by excess fuel, or oil in the combustion chamber. Excess fuel could be caused by operating the engine with too much choke. Oil in the combustion chamber is usually caused by worn piston rings or valve guides.

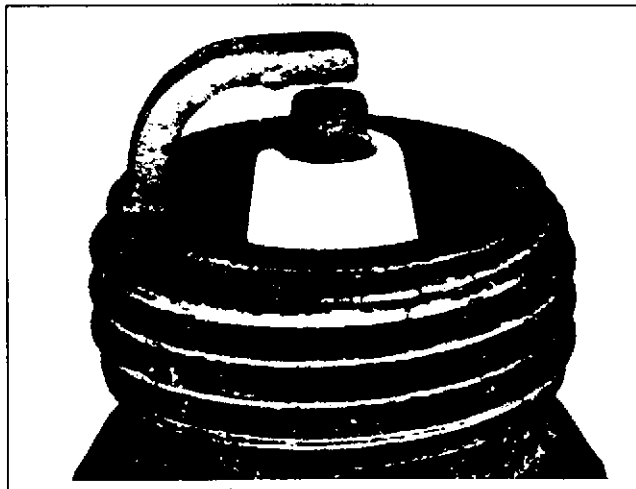

Chalky White Deposits: Chalky white colored deposits indicate overheating. This condition is usually accompanied by excessive gap erosion. A clogged grass screen, clogged cooling fins, and lean carburetion are some causes of overheating.

ELECTRONIC MAGNETO IGNITION SYSTEM

These engines are equipped with a dependable electronic magneto ignition system. The system consists of the following components:

- A magnet assembly which is permanently affixed to the flywheel.
- An electronic magneto ignition module which mounts on the engine crankcase.
- A kill switch (or key switch) which grounds the module to stop the engine. NOTE: Certain CH6 models use a spring loaded "kill" switch which is held against the spark plug to stop the engine.
- A spark plug.

Operation

As the flywheel rotates and the magnet assembly moves past the ignition module, a low voltage is induced in the primary windings of the module. When the primary voltage is precisely at its peak, the module induces a high voltage in its secondary windings. This high voltage creates a spark at the tip of the spark plug. This spark ignites the air-fuel mixture in the combustion chamber.

The timing of the spark is automatically controlled by the module. Therefore, other than periodically checking/replacing the spark plug, no maintenance, timing, or adjustments are necessary or possible with this system.

In the event starting problems should occur which are not corrected by replacing the spark plug, refer to the following "Troubleshooting Guide" for trouble analysis procedures.

**SECTION 8
ELECTRICAL SYSTEM AND COMPONENTS**

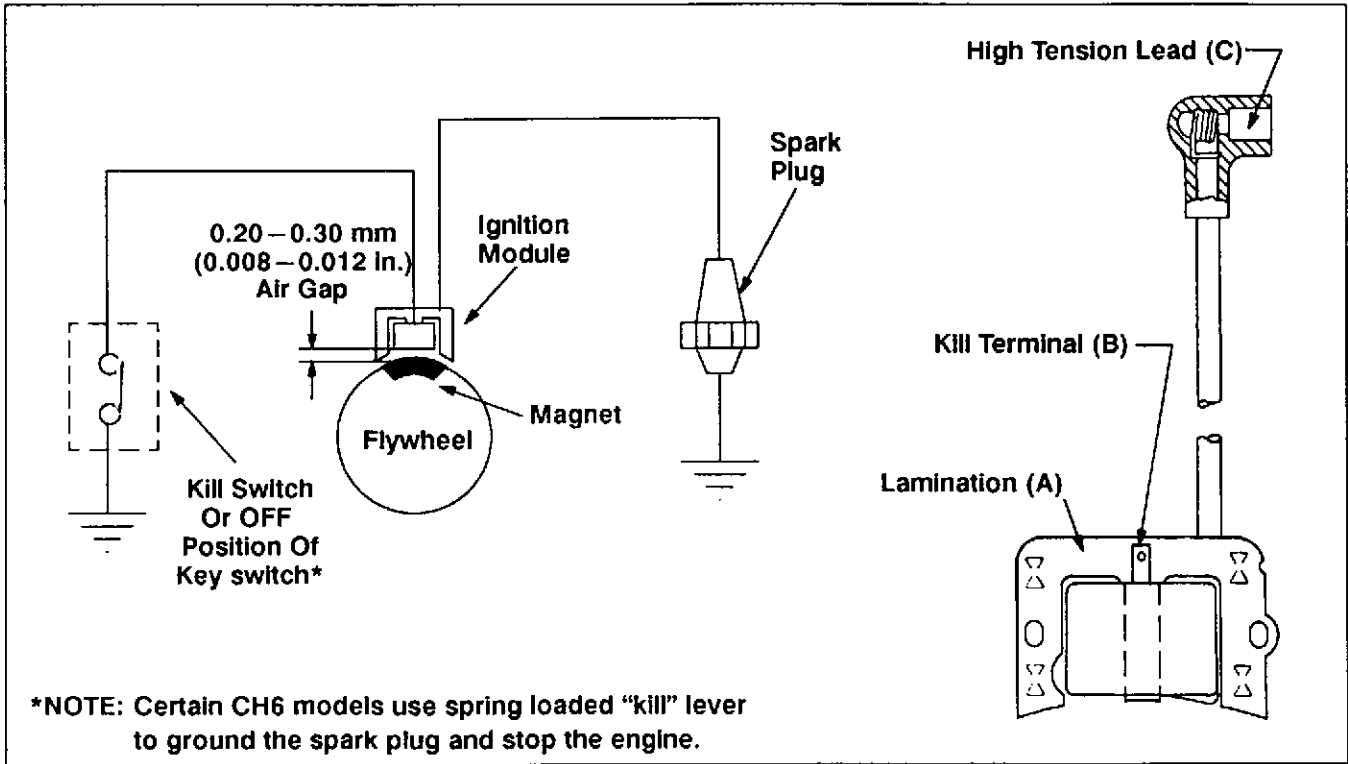

Figure 8-2. Electronic Magneto Ignition System.

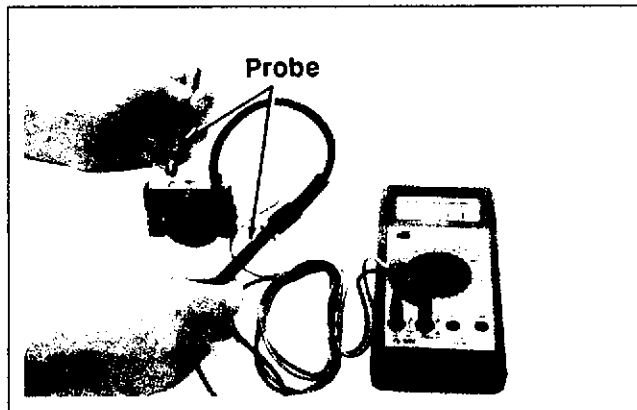

Figure 8-3. Testing Module Secondary.

**Ignition System
Troubleshooting Guide**

The following guide will help locate and correct ignition system-related starting problems. This procedure uses a simple tester which can easily be made by the

serviceman. Refer to Section 2—"Special Tools" for ignition system tester construction details.

NOTE: Use a low-voltage (2 volts or less) ohmmeter when ohmmeter is required. Always zero ohmmeter on each scale before testing to ensure accurate readings.

Problem	Test	Conclusion
ENGINE WILL NOT START	1. Make sure the spark plug lead is connected to the spark plug.	
	2. Check the condition of spark plug. Make sure gap is set to 1.02 mm (0.040 in.) .	2. If plug is in good condition, check/adjust gap and reinstall.
	3. Check ignition module using test plug. (Refer to Section 2—"Special Tools.") a. Remove the high-tension lead from the engine spark plug and connect it to the test plug. NOTE: To maintain engine speeds normally obtained during cranking, do not remove the engine spark plug. b. Make sure the engine ignition switch, kill switch, or key switch is in the "run" position. c. Crank the engine and observe the test plug. Visible and audible sparks should be produced.	3. If visible and audible sparks are produced, the ignition module is OK. If visible and audible sparks are not produced: a. Make sure the engine ignition switch, kill switch, or key switch is in the "run" position. b. Check wires and terminals of ignition module and other components for accidental grounding and damaged insulation. c. If wires and terminals are OK, the ignition module is probably faulty and should be replaced. Test module further using an ohmmeter (Test 4).
	4. Measure the resistance of module secondary using an ohmmeter (see Figures 8-2 and 8-3): Connect one ohmmeter lead to laminations (A). Connect the other lead to the spark plug terminal of high-tension lead (C). With the ohmmeter leads connected in this manner, the resistance of secondary should be 7,900 to 10,850 ohms . NOTE: This test cannot be performed unless module has been fired at least once.	If the resistance is low or 0 ohms , the module secondary is shorted. Replace the module. If the resistance is high or infinity ohms , the module secondary is open. Replace the module. If the resistance is within the specified range, the module secondary is OK.

SECTION 8 ELECTRICAL SYSTEM AND COMPONENTS

Ignition Module Removal and Installation

Refer to the Disassembly and Reassembly Sections for complete ignition module removal and installation procedures.

BATTERY

A 12-volt battery with a rating of at least 250 cold cranking amps. is normally used. Refer to the operating instructions of the equipment this engine powers for specific information.

If the battery charge is not sufficient to crank the engine, recharge the battery.

NOTE: Do not attempt to "jump start" the engine with another battery. Starting the engine with batteries larger than those recommended can burn out the starter motor.

Battery Charging



WARNING: Dangerous Acid, Explosive Gases!

Batteries contain sulfuric acid. To prevent acid burns, avoid contact with skin, eyes, and clothing. Batteries produce explosive hydrogen gas while being charged. To prevent a fire or explosion, charge batteries only in well ventilated areas. Keep sparks, open flames, and other sources of ignition away from the battery at all times. Keep batteries out of the reach of children. Remove all jewelry when servicing batteries.

Before disconnecting the negative (-) ground cable, make sure all switches are OFF. If ON, a spark will occur at the ground cable terminal which could cause an explosion if hydrogen gas or gasoline vapors are present.

Battery Maintenance

Regular maintenance will ensure the battery will accept and hold a charge.

1. Regularly check the level of electrolyte. Add distilled water as necessary to maintain the recommended level.

NOTE: Do not overfill the battery. Poor performance or early failure due to loss of electrolyte will result.

2. Keep the cables, terminals, and external surfaces of battery clean. A build-up of corrosive acid or grime on the external surfaces can self-discharge the battery. Self-discharging happens rapidly when moisture is present.
3. Wash the cables, terminals, and external surfaces with a baking soda and water solution. Rinse thoroughly with clear water.

NOTE: Do not allow the baking soda solution to enter the cells as this will destroy the electrolyte.

Battery Test

Test the battery voltage by connecting D.C. voltmeter across the battery terminals – crank the engine. If the battery drops below 9 volts while cranking, the battery is discharged or faulty. Refer to Figure 8-4.

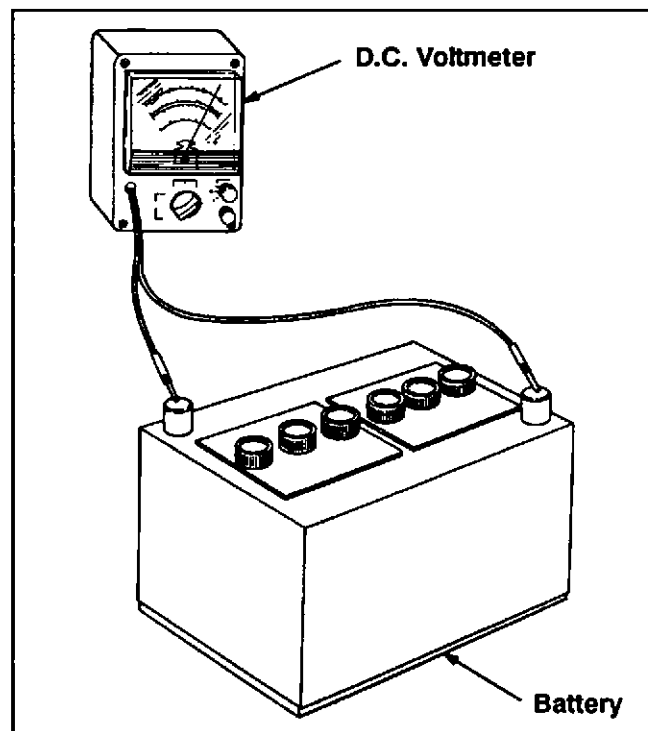

Figure 8-4. Checking Battery Voltage.

ELECTRICAL SYSTEMS WIRING DIAGRAMS AND BATTERY CHARGING SYSTEMS

Some engines are equipped with a 0.5 amp unregulated battery charging system.

Refer to the following wiring diagram and troubleshooting guide to test and service this system.

NOTE: Observe the following guidelines to prevent damage to the electrical system and components.

1. Make sure the battery polarity is correct. A negative (-) ground system is used.
2. Disconnect the stator lead, wiring harnesses, and any other electrical accessories in common ground with the engine before performing electric welding on the equipment powered by the engine.
3. Prevent the stator lead from touching or shorting while the engine is running. This could damage the stator.

Electric Start Engines 0.5 Amp Unregulated Battery Charging System

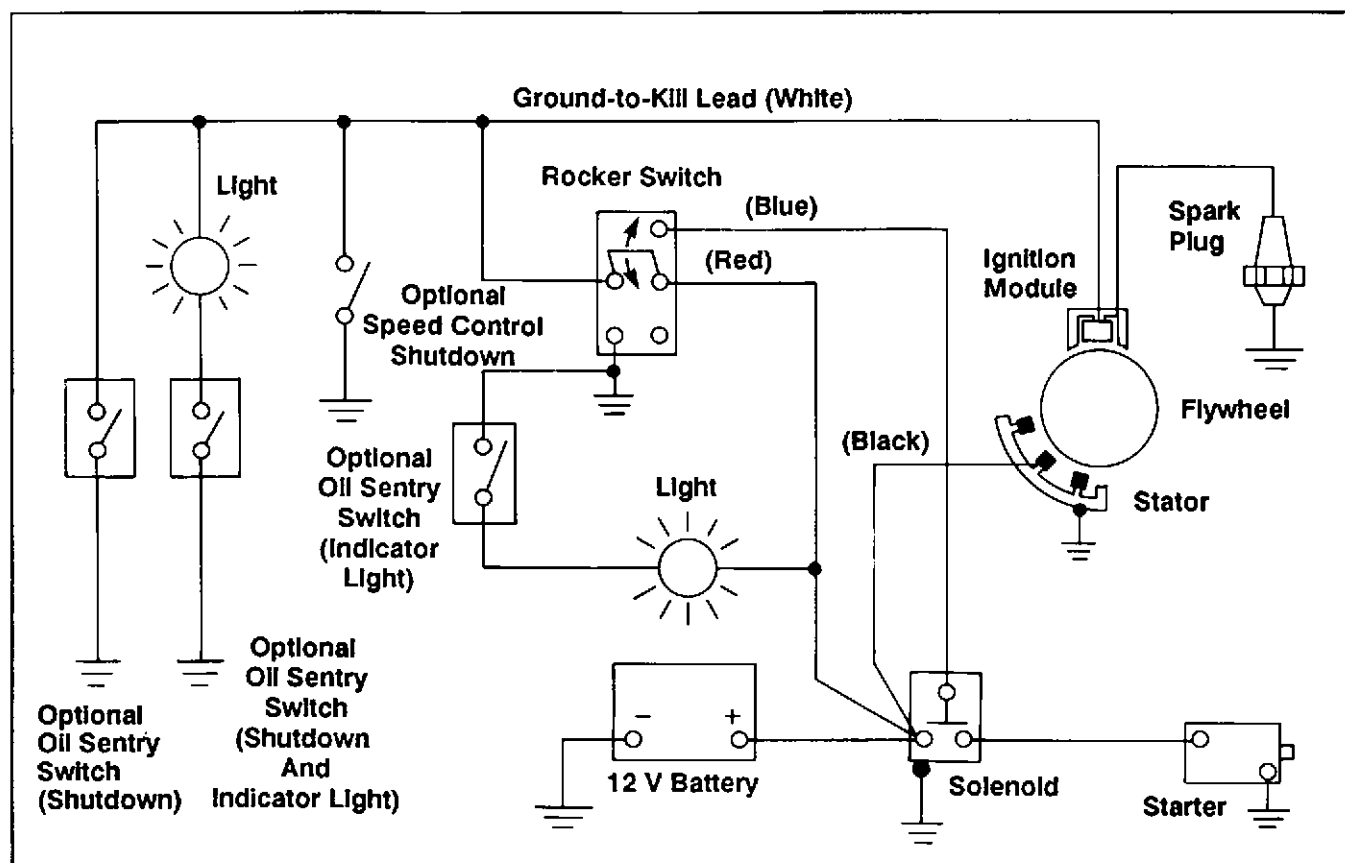

Figure 8-5. Wiring Diagram – Electric Start Engines 0.5 Amp Unregulated Battery Charging System.

SECTION 8 ELECTRICAL SYSTEM AND COMPONENTS

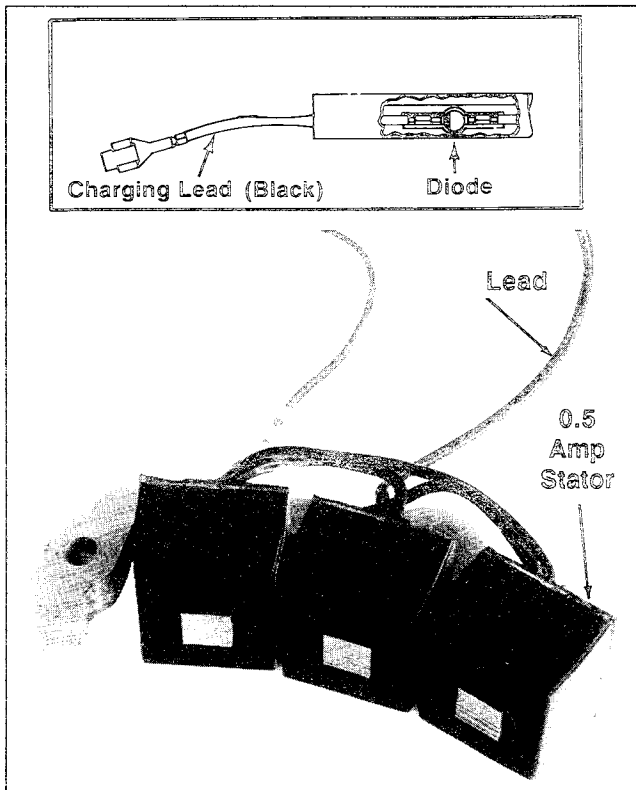
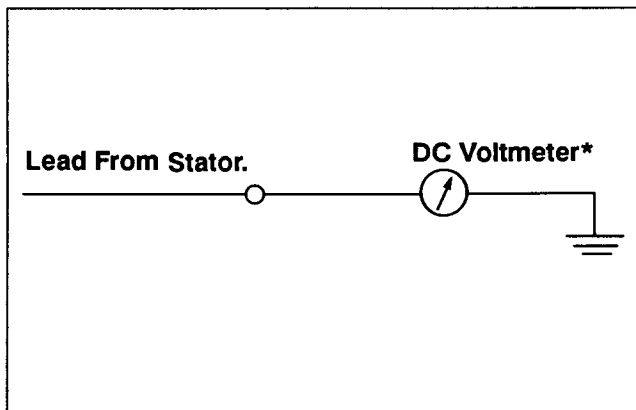

Figure 8-6. 0.5 Amp Stator.

Troubleshooting Guide 0.5 Amp Unregulated System

1. Test Circuit.



2. Minimum Output.

<u>Engine Speed</u>	<u>Output (DC Volts)*</u>
1600	2.49/3.39
2000	4.19/5.57
2400	7.18/9.10
2800	9.68/11.90
3200	11.90/14.00
3600	13.29/14.97
4000	14.34/16.80

If voltage is significantly lower than listed values replace stator.

*NOTE: Voltmeter must have an integrating time (RMS) function to yield a true DC reading, and a high input impedance ($> 10 \text{ M } \Omega$) such that the output voltage is not artificially lowered due to meter loading.

ELECTRIC STARTER

NOTE: Do not crank the engine for more than 10 seconds at a time. If the engine does not start, allow a 60-second cool-down period between starting attempts. Failure to follow these guidelines can burn out the starter motor.

NOTE: If the engine develops sufficient speed to disengage the starter but does not keep running (a false start), the engine rotation must be allowed to come to a complete stop before attempting to restart the engine. If the starter is engaged while the flywheel is rotating, the starter pinion and flywheel ring gear may clash, resulting in damage to the starter.

NOTE: If the starter does not crank the engine, shut off the starter immediately. Do not make further attempts to start the engine until the condition is corrected. Do not attempt to jump start the engine with another battery. Starting with batteries larger than those recommended can burn out the starter motor.

NOTE: Do not drop the starter or strike the starter frame. Doing so can damage the ceramic permanent magnets inside the starter frame.

BENDIX DRIVE ELECTRIC STARTER

This subsection covers the operation, troubleshooting, and repair of the Bendix drive permanent magnet electric starter.

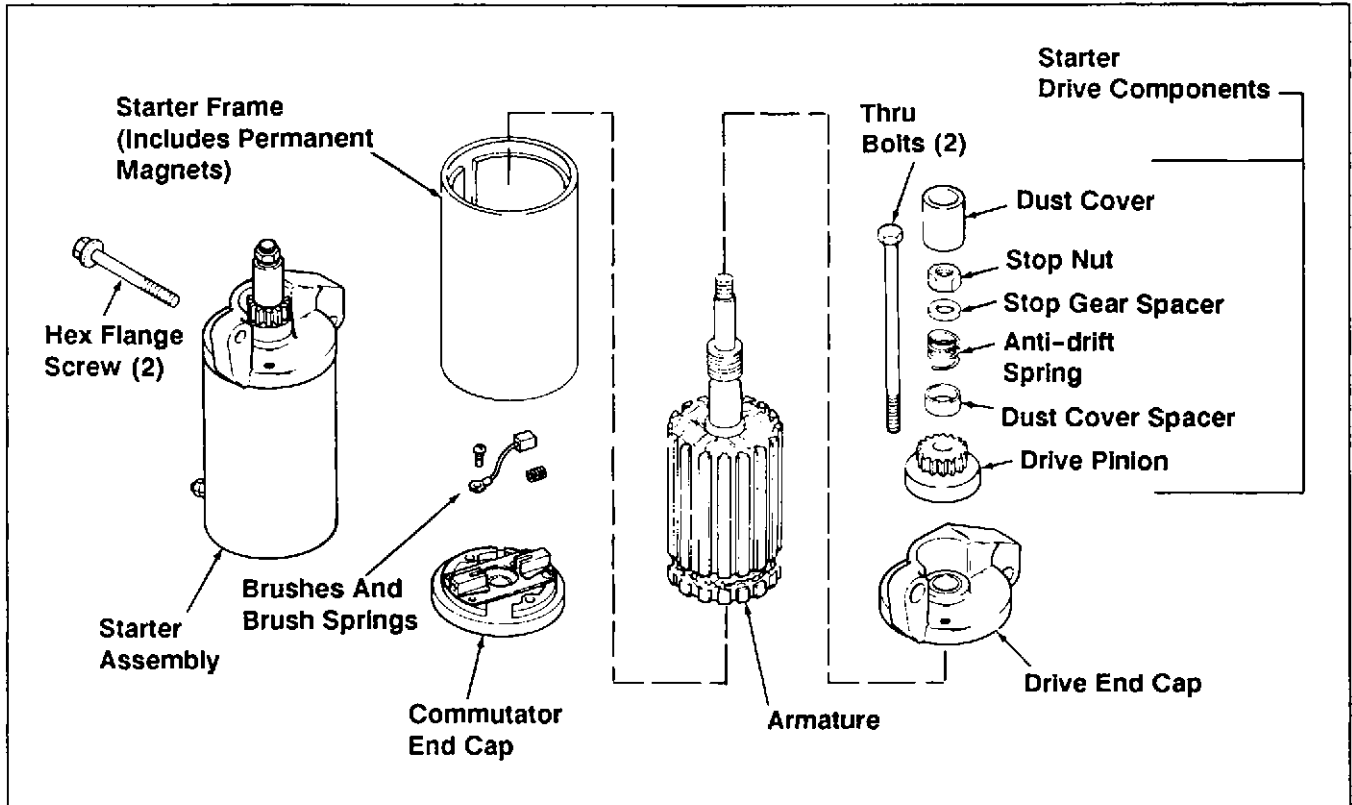

Figure 8-7. Bendix Drive Electric Starter.

Operation

When power is applied to the starter, the armature rotates. As the armature rotates, the drive pinion moves out on the splined drive shaft and into mesh with the flywheel ring gear. When the pinion reaches the end of the drive shaft, it rotates the flywheel and "cranks" the engine.

When the engine starts, the flywheel rotates faster than the starter armature and drive pinion. This moves the drive pinion out of mesh with the ring gear and into the retracted position. When power is removed from the starter, the armature stops rotating and the drive pinion is held in the retracted position by the anti-drift spring.

SECTION 8 ELECTRICAL SYSTEM AND COMPONENTS

Troubleshooting Guide

Problem	Possible Fault	Correction
Starter Does Not Energize	Battery	1. Check the specific gravity of battery. If low, recharge or replace battery as necessary.
	Wiring	1. Clean corroded connections and tighten loose connections. 2. Replace wires in poor condition and with frayed or broken insulation.
	Starter Switch Or Solenoid	1. Bypass the switch or solenoid with a jumper wire. If starter cranks normally, replace the faulty components.
Starter Energizes But Turns Slowly	Battery	1. Check the specific gravity of battery. If low, recharge or replace battery as necessary.
	Brushes	1. Check for excessively dirty or worn brushes and commutator. Clean using a coarse cloth (not emery cloth). 2. Replace brushes if excessively or unevenly worn.
	Transmission Or Engine	1. Make sure the clutch or transmission is disengaged or placed in neutral. This is especially important on equipment with hydrostatic drive. The transmission must be exactly in neutral to prevent resistance which could keep the engine from starting. 2. Check for seized engine components such as the bearings, connecting rod, and piston.

Starter Removal And Installation

Refer to the "Disassembly" and "Reassembly" Sections for starter removal and installation procedures.

Starter Drive Service (Refer To Figure 8-7.)

Every **500 hours** of operation (or annually, whichever occurs first), clean and lubricate the splines on the starter drive shaft. If the drive pinion is worn, or has chipped or broken teeth, it must be replaced.

It is not necessary to completely disassemble the starter to service the drive components. Service the drive as follows:

1. Remove the starter from the engine.
2. Remove the dust cover.

3. Hold the drive pinion in a vice with soft jaws when removing and installing the stop nut. The armature will rotate with the nut until the drive pinion stops against internal spacers.

NOTE: Do not overtighten the vise as this can distort the drive pinion.

4. Remove the stop nut, stop gear spacer, anti-drift spring, dust cover spacer, and drive pinion.
5. Clean the splines on drive shaft thoroughly with solvent. Dry the splines thoroughly.
6. Apply a small amount of Kohler electric starter drive lubricant, **Part No. 52 357 01**, to the splines.

NOTE: Kohler electric starter drive lubricant, **Part No. 52 357 01**, must be used on all Kohler electric starter drives. The use of other lubricants can cause the drive pinion to stick or bind.

7. Apply a small amount of Loctite® No. 271 to the stop nut threads.
8. Install the drive pinion, dust cover spacer, anti-drift spring, stop gear spacer, and stop nut. Torque the stop nut to **17.0 – 19.2 N•m (150 – 170 in. lb.)**.
9. Install the dust cover.

Starter Disassembly

1. Remove the dust cover, stop nut, stop gear spacer, anti-drift spring, dust cover spacer, and drive pinion. Refer to “Starter Drive Service” above.
2. Scribe a small line on the drive end cap, opposite the line on the starter frame. These lines will serve as match marks when reassembling the starter. See Figure 8-8.

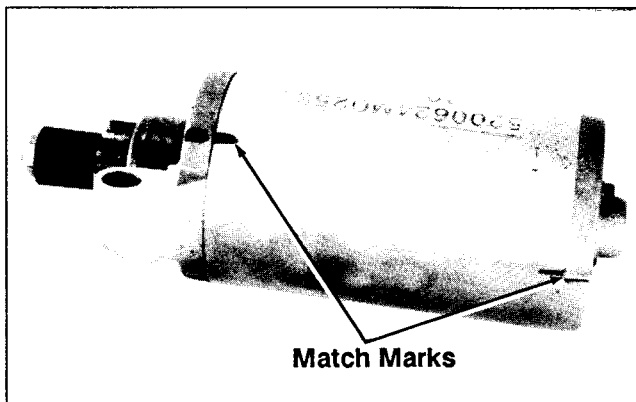

Figure 8-8. Starter Assembly Match Marks.

3. Remove the thru bolts.
4. Remove the commutator end cap with brushes and brush springs.

NOTE: The wiring lead of the positive (+) brush is attached to the insulated terminal on the starter frame. When the commutator end cap is removed, the positive (+) brush should be removed from the brush guide of the brush holder, and will remain attached to the starter frame insulated terminal.

5. Remove the drive end cap.
6. Remove the armature and thrust washer from inside the starter frame.

Brush Replacement

1. Remove the brush springs from the brush guides of the brush holder. See Figure 8-9.

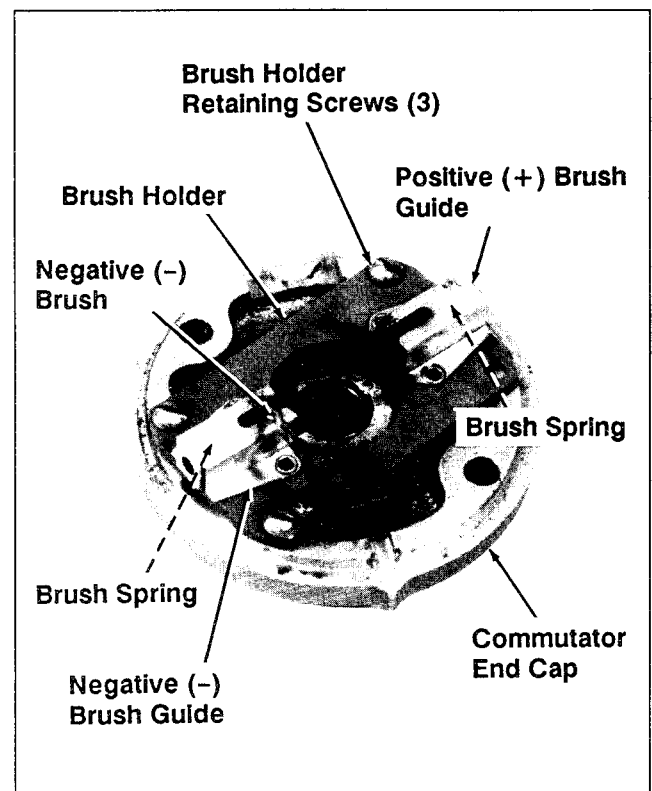

Figure 8-9. Commutator End Cap With Brushes.

2. Remove the brush holder screws, negative (-) brush, and plastic brush holder.
3. Remove the hex. nuts from the stud terminal. See Figure 8-10.

SECTION 8 ELECTRICAL SYSTEM AND COMPONENTS

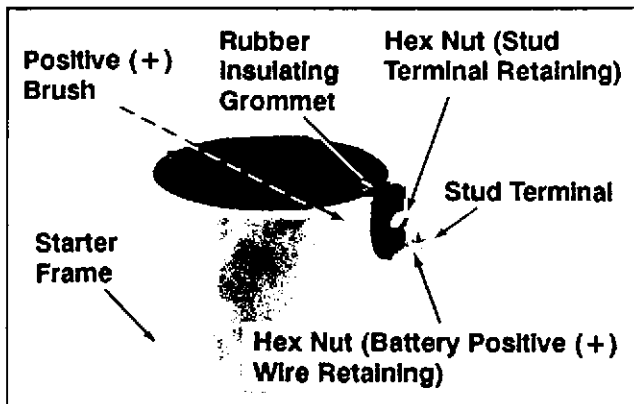

Figure 8-10. Commutator End Cap With Brushes.

Remove the stud terminal with positive (+) brush and rubber insulating grommet from the starter frame.

4. Reinstall the insulating grommet to the new stud terminal with positive (+) brush. Install the stud terminal with grommet onto the starter frame. Secure the stud with the hex. nut.
5. Install the brush holder, new negative (-) brush, and brush holder screws.
6. Install the brush springs and brushes into the brush guides of the brush holder. Make sure the chamfered sides of the brushes are facing away from the brush springs.

Commutator Service

Clean the commutator with a coarse, lint free cloth. Do not use emery cloth.

If the commutator is badly worn or grooved, turn it down on a lathe or replace the armature.

Starter Reassembly

1. Place the thrust washer over the drive shaft of armature.
2. Insert the armature into the starter frame. Make sure the magnets are closer to the drive shaft end of armature. The magnets will hold the armature inside the frame.

3. Install the drive end cap over the drive shaft. Make sure the match marks on the end cap and starter frame are aligned. See Figure 8-8.

4. Align the match marks on the commutator end cap and starter frame. Hold the drive end and commutator end caps firmly to the starter frame. Remove the brush holder tool.

5. Install the thru bolts and tighten securely.

6. Lubricate the drive shaft with Kohler electric starter drive lubricant. Install the drive pinion, dust cover spacer, anti-drift spring, stop gear spacer, stop nut, and dust cover. Refer to "Starter Drive Service" above.

OIL SENTRY™ OIL LEVEL MONITOR



Operation

Some engines are equipped with optional Oil Sentry™ system. Oil Sentry™ uses a float switch in the oil pan to detect a low engine oil level. On stationary or unattended applications (pumps, generators, etc.) the float switch can be used to ground the ignition module to stop the engine. On vehicular applications (garden tractors, mowers, etc.) and those equipped with a battery or electric start, the float switch can be used to activate a "low oil" warning light.

NOTE: Refer to the Specifications in the "Safety and General Information" Section for maximum angles of operation for engines equipped with Oil Sentry™. Always operate the engine within the guidelines specified. Operating the engine at angles greater than specified could cause the engine to stop if wired for low oil shut off.

The following instructions will enable switch removal, installation, and testing without removing the oil pan. Follow these instructions carefully to prevent damage to the switch.

Float Switch Removal

1. Make sure the engine/equipment is resting on a level surface.
2. Remove the oil drain plug and drain oil from crankcase.
3. Disconnect float switch leads.
4. Using a 9/16" open end wrench, turn switch counterclockwise 1/4 TURN to loosen. STOP turning switch when flat surface on float switch is in a horizontal position. (Flat surface parallel with base of oil pan and N.C./N.O. markings down.) Refer to Figures 8-11 and 8-12.

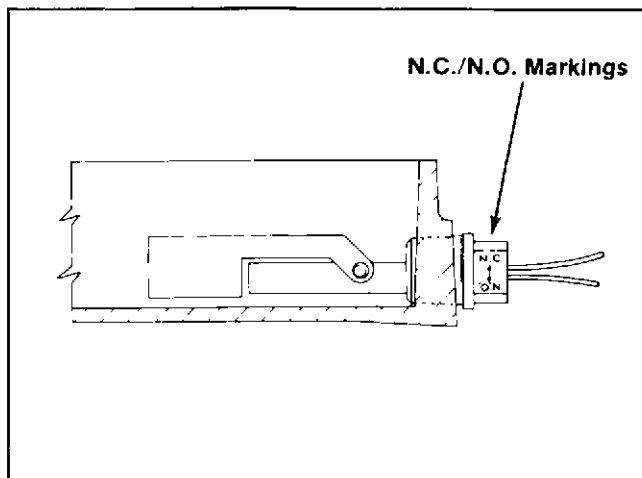

Figure 8-11. Float Switch Removal.

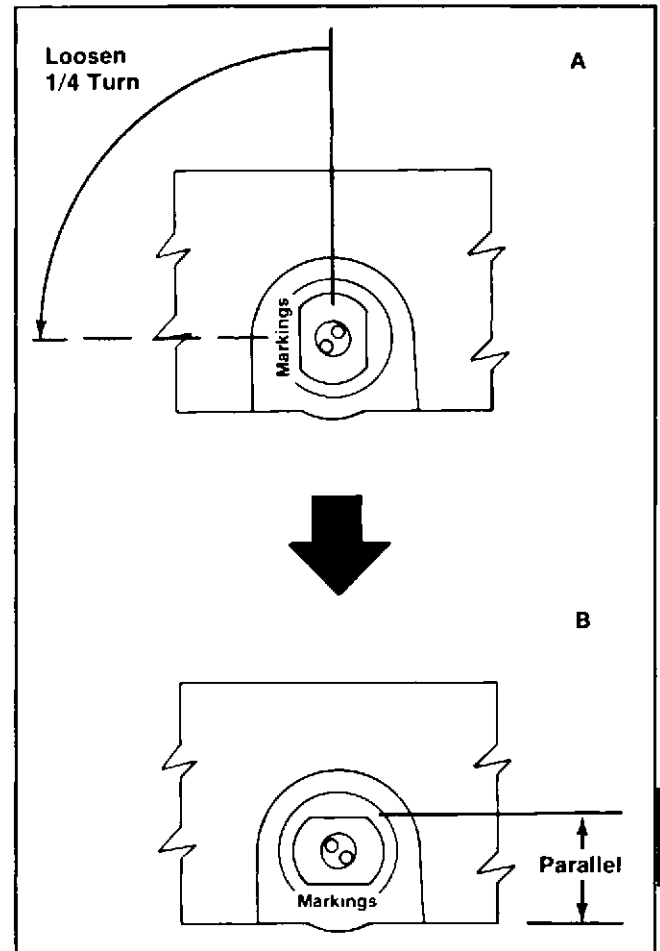

Figure 8-12. Float Switch Removal.

5. Turn the switch counterclockwise in 1/2 TURN INCREMENTS using a smooth, continuous action. Pause briefly between increments and keep the flat surface of float switch in a horizontal position (parallel with base of oil pan). Refer to Figure 8-13.

SECTION 8 ELECTRICAL SYSTEM AND COMPONENTS

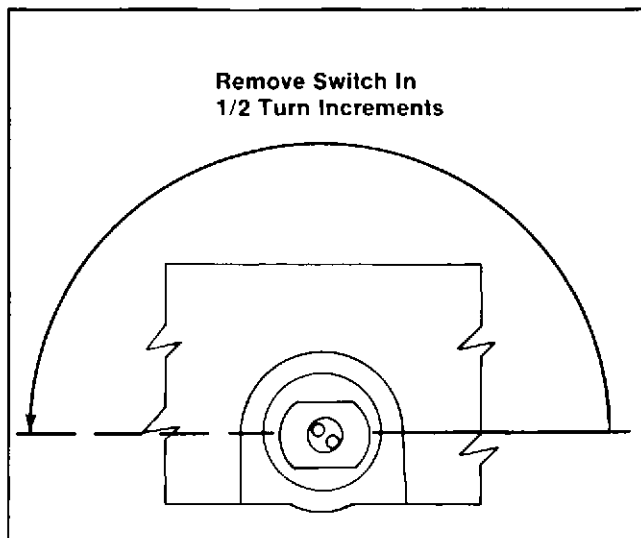

Figure 8-13. Float Switch Removal.

CAUTION: To prevent damage to the float switch, and to enable you to “feel” if the float strikes the oil pan, REMOVE THE SWITCH BY HAND as soon as it is loose enough for you to do so.

When turning the float switch, use a smooth, continuous action for the ENTIRE 1/2 turn increment. Pausing the rotation of the switch in the position shown in Figure 8-14 will cause the float to strike the oil pan.

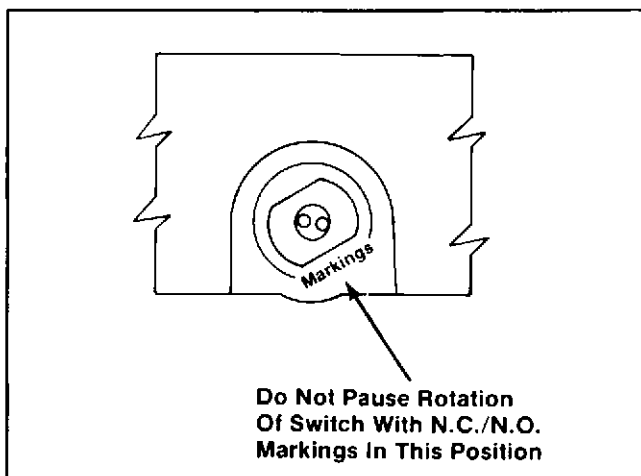

Figure 8-14. Float Switch Removal.

If the float strikes the oil pan, STOP turning the switch, then use the following procedure.

- Turn the switch clockwise until the flat surface is in a vertical position as shown in Figure 8-12. (N.C./N.O. markings on left.) This will allow the float to return against the switch body.
- Turn the switch counterclockwise 1/4 TURN. STOP turning switch when flat surface is in a horizontal position. (Flat surface parallel with base of oil pan and N.C./N.O. markings down. Refer to Figure 8-12.
- Turn the switch counterclockwise in 1/2 TURN INCREMENTS as instructed in Step 5 above.

Float Switch Installation

- Make sure the engine/equipment is resting on a level surface.
- Remove the oil drain plug and drain oil from crankcase if oil has not already been drained.

CAUTION: To prevent damage to the float switch, and to enable you to “feel” if the float strikes the oil pan, INSTALL THE SWITCH BY HAND as long as it is loose enough for you to do so.

- Apply Loctite® No. 592 Teflon® sealant (or equivalent) to the entire thread area of switch.
- Apply a thick film of clean SAE 30 oil to the float and switch body as shown in Figure 8-15.

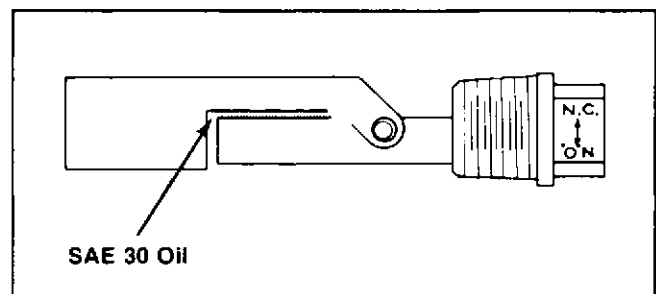

Figure 8-15. Float Switch Removal.

SECTION 8 ELECTRICAL SYSTEM AND COMPONENTS

5. Hold the switch with the flat surface in a vertical position. (N.C./N.O. marking to the left.) Insert the switch into the oil pan and turn the switch 1/4 turn. STOP turning the switch when the flat surface on switch is in a horizontal position. Flat surface parallel with base of oil pan and N.C./N.O. markings up.) Refer to Figure 16.

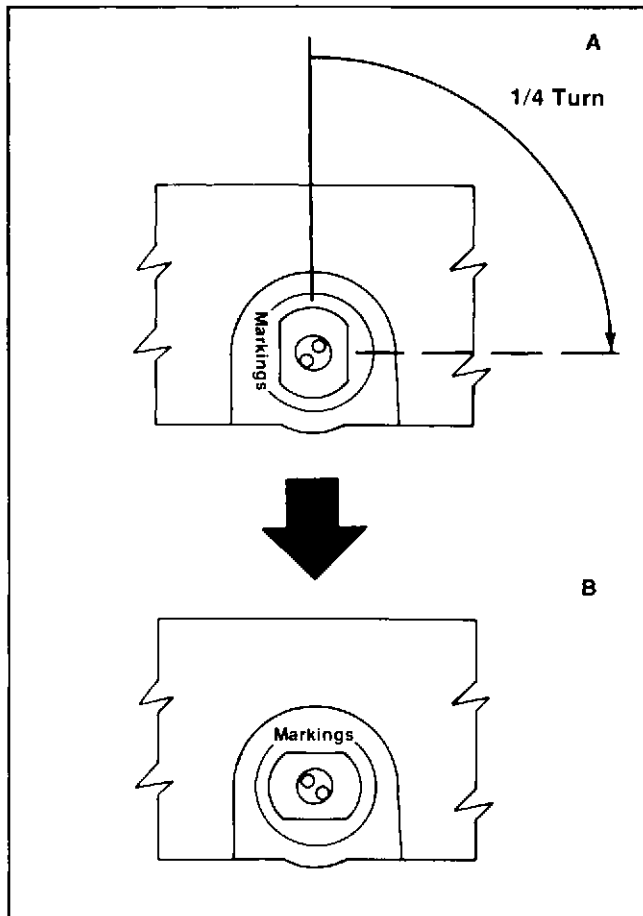

Figure 8-16. Float Switch Installation.

6. Turn the switch clockwise in 1/2 TURN INCREMENTS using a smooth continuous action. Pause briefly between increments and keep the flat surface of switch in a horizontal position (parallel with base of oil pan.) Refer to Figure 8-17.

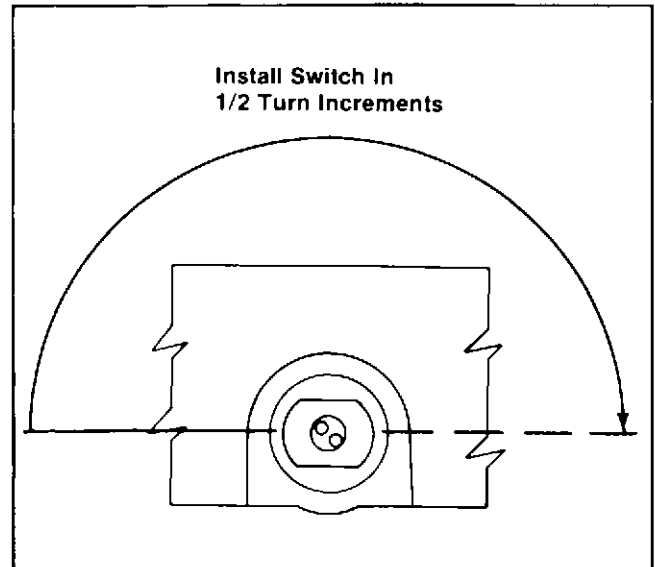

Figure 8-17. Float Switch Installation.

NOTE: Several "1/2 increments" may be required until the threads on switch engage in oil pan.

CAUTION: When turning the float switch, use a smooth continuous action for the entire 1/2 turn increment. Pausing the rotation of the switch in the position shown in Figure 8-18 will cause the float to strike the oil pan.

SECTION 8 ELECTRICAL SYSTEM AND COMPONENTS

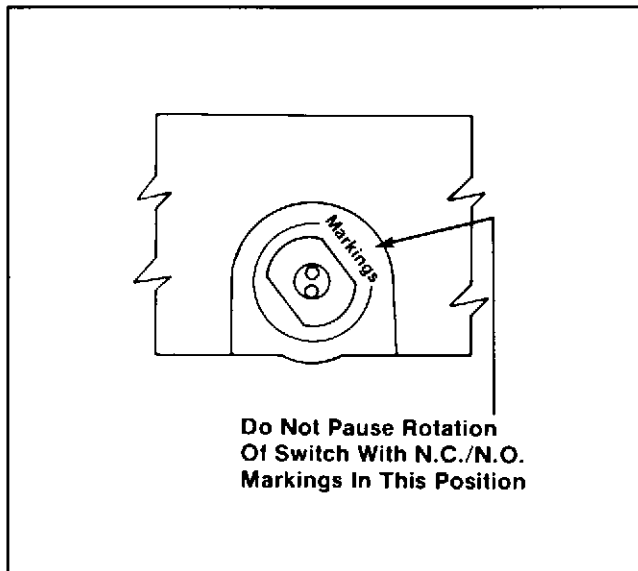

Figure 8-18. Float Switch Installation.

If the float does strike the oil pan, STOP turning the switch, and use the following procedure.

- A. Turn the switch counterclockwise until the flat surface is in a vertical position, (N.C./N.O. markings on left.) This will allow the float to return against the switch body. Refer to Figure 8-16A.
- B. Turn the switch clockwise 1/4 TURN. STOP turning switch when flat surface is in a horizontal position. (Flat surface parallel with base of oil pan and N.C./N.O. markings up.) Refer to Figure 8-16.
- C. Turn the switch clockwise in 1/2 TURN INCREMENTS as instructed in Step 7 above.
8. Turn in the switch approximately five (5) to six (6) full turns to obtain the proper position. Use a 9/16" open end wrench to tighten the switch. The "N.C." markings on switch will be at the top when the switch is positioned properly as shown in Figure 8-19.

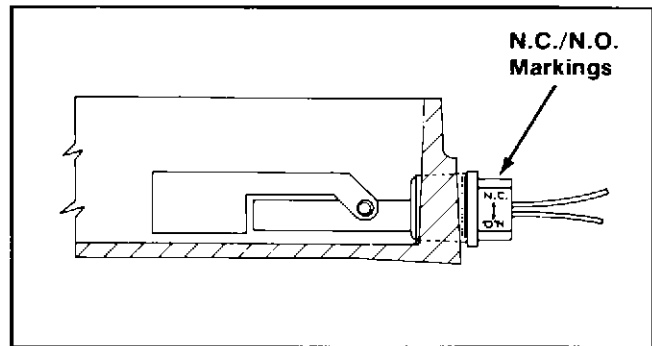

Figure 8-19. Float Switch Installation.

Float Switch Test

Perform the following tests to ensure that the float switch is positioned and working properly before connecting the leads. Refer to Figure 8-20.

NOTE: These tests apply to engines equipped with a standard oil pan. Special oil pan and/or dipstick arrangements can give inaccurate test results.

1. Connect a continuity test light across float switch leads. The light **should be "on"**.
2. Install oil drain plug and refill crankcase with oil. The light **should be "off"** after oil is above the "L" mark on the dipstick or proper level on CH6 models.
3. If the float switch fails this test:
 - A. Make sure the switch is in the proper position with the "N.C." markings at the top. Refer to Figure 8-19.
 - B. If switch is positioned properly, drain oil and remove switch (see "Float Switch Removal"). If the float is not attached to the switch body, the closure plate must be removed.
 - C. Replace a faulty or broken switch with a new one. (See "Float Switch Installation".)

Switch Position	Continuity
A	No (Switch open)
B	Yes (Switch closed)

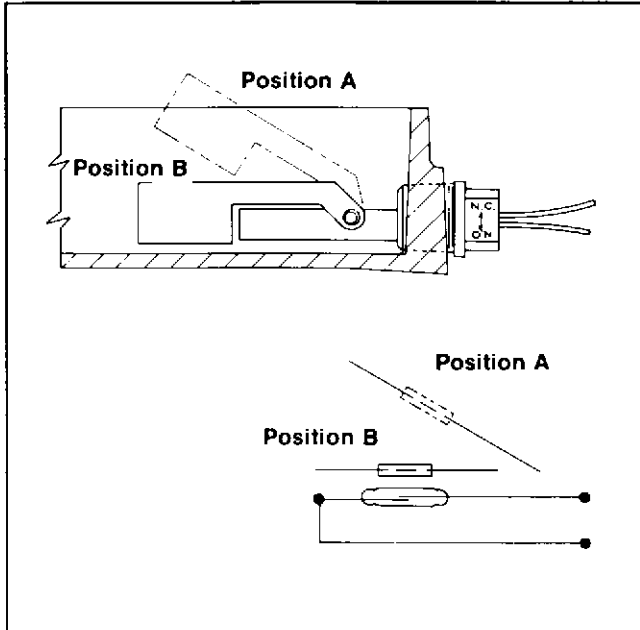

Figure 8-20. Float Switch Test.

Operational Test

Reconnect the leads and perform the following test.

1. Make sure the oil level is up to, but not over the "F" mark on dipstick.
2. Start the engine.

If the switch is wired as a low oil level shutdown, the engine should start.

If the switch is wired to activate a low oil warning light, the light should be "off."

3. Stop the engine. Drain the oil until the oil level is below the "L" mark on dipstick or lower than bottom of filler neck on CH6. If properly wired, the engine will not start, or the light will be "on".
4. If the test results of Steps 2 and 3 are not as indicated, check for improper wiring and/or improper float installation.

SECTION 9 DISASSEMBLY

The following sequence is suggested for complete engine disassembly. This procedure can be varied to accommodate options or special equipment.

Clean all parts thoroughly as the engine is disassembled. Only clean parts can be accurately inspected and gauged for wear or damage. There are many commercially available cleaners that will quickly remove grease, oil, and grime from engine parts. When such a cleaner is used, follow the manufacturer's instructions and safety precautions carefully.

Make sure all traces of the cleaner are removed before the engine is reassembled and put into operation. Even small amounts of these cleaners can quickly break down the lubricating properties of engine oil.

TYPICAL DISASSEMBLY SEQUENCE

1. Disconnect spark plug lead.
2. Drain oil from crankcase.
3. Remove air cleaner.
4. Remove retractable starter.
5. Remove dipstick and fill tube.
6. Remove fuel tank and line.
7. Remove carburetor and linkage.
8. Remove muffler.
9. Remove blower housing and baffles.
10. Remove governor, throttle and kill switch linkage.
11. Remove valve cover and cylinder head.
12. Remove ignition module.
13. Remove flywheel.
14. Remove closure plate.
15. Remove camshaft and tappets.
16. Remove governor gear and cross shaft.
17. Remove oil sentry.
18. Remove connecting rod and piston.
19. Remove piston from connecting rod.
20. Remove piston rings.

21. Remove crankshaft.
22. Remove crankshaft oil seals and bearings.

DISCONNECT SPARK PLUG LEAD DRAIN OIL FROM CRANKCASE

1. Remove the oil drain plug and oil fill cap/dipstick or oil fill/check plug on CH6. See Figure 9-1.

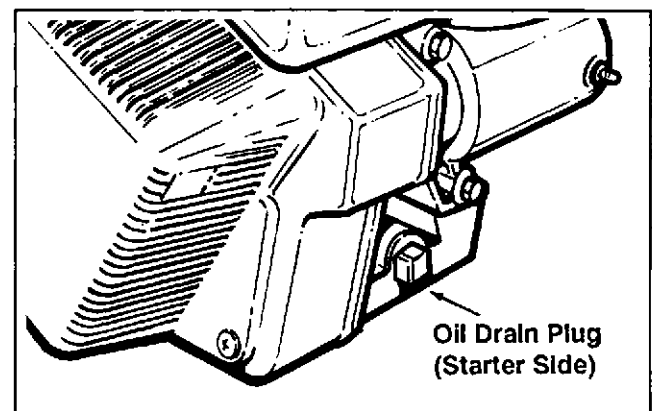

Figure 9-1. Draining Oil.

2. Allow ample time for the oil to drain from the crankcase. Tip engine to speed draining.

REMOVE AIR CLEANER COMPONENTS

Remove the air cleaner components from the air cleaner base as described in Section 4A for the CH5 and Section 4B for CH6 models. Remove the bases as follows:

1. Remove the two base mounting screws.
2. Remove the two nuts securing the base to the carburetor studs.
3. Disconnect the breather tube from the air cleaner base.

SECTION 9 DISASSEMBLY

4. Remove the base and gaskets to complete removal of air cleaner components from the engine.

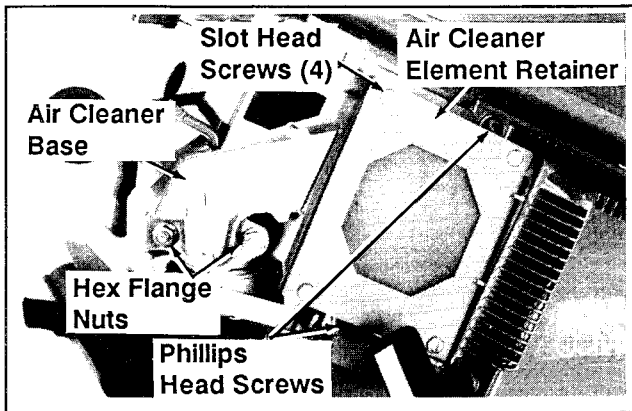

Figure 9-2. Removing CH5 Air Cleaner Base.

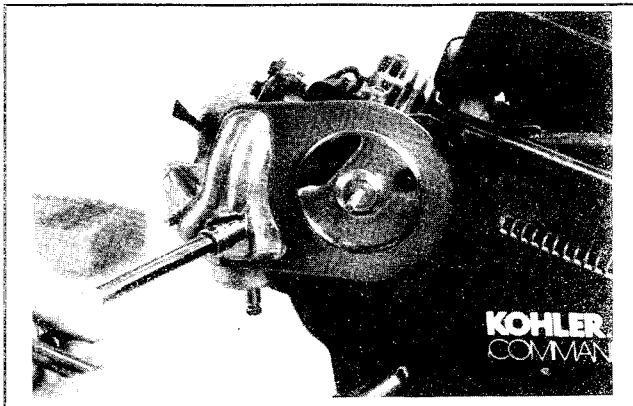

Figure 9-3. Removing CH6 Air Cleaner Base.

REMOVE RETRACTABLE STARTER

Remove Phillips head screws and the retractable starter. See Figure 9-4.

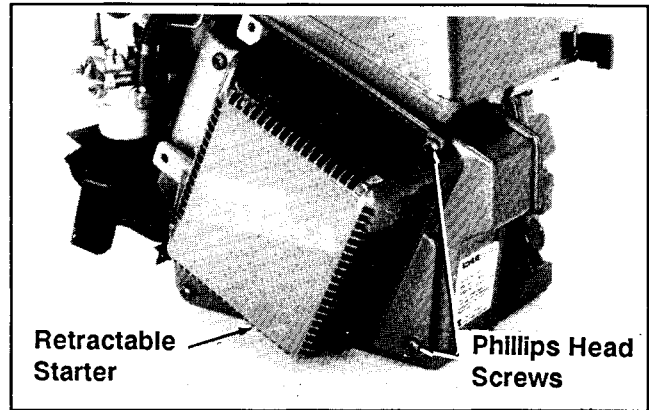

Figure 9-4. Removing (CH5 Shown) Retractable Starter.

REMOVE DIPSTICK AND FILL TUBE (CH5)

1. Remove the hex. flange screw and nut securing the oil fill tube to the fuel tank. See Figure 9-5.

NOTE: Some CH5 models use an oil fill tube with bracket at base of tube. On these remove screw at base.

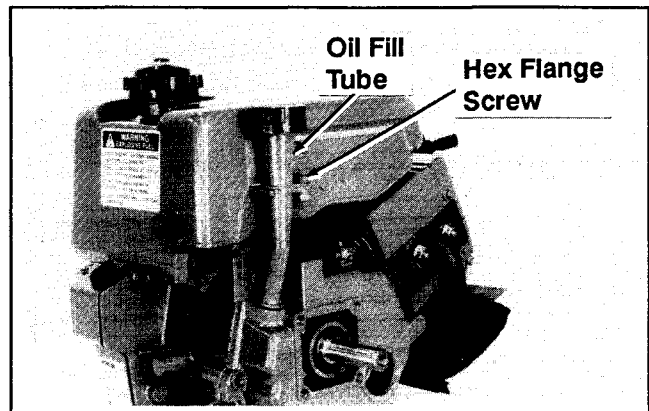

Figure 9-5. Removing Oil Fill Tube On CH5. (Earlier Tank Mounting Shown.)

2. Remove the oil fill tube from the crankcase.

NOTE: CH6 models do not have the extended oil fill tube and dipstick.

REMOVE FUEL TANK AND LINE

WARNING: Gasoline may be present in the carburetor and fuel system. Gasoline is extremely flammable, and its vapors can explode if ignited. Keep sparks, open flames, and other sources of ignition away from the engine.

1. Turn the fuel shut-off valve to the OFF position.
2. Disconnect the fuel line from the inlet fitting of the carburetor. See Figure 9-6.

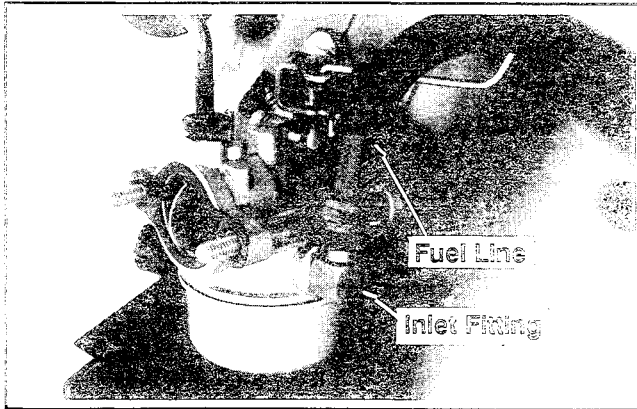

Figure 9-6. Disconnecting Fuel Line.
(CH5 Carburetor Shown)

3. Remove the hex. flange screws securing the fuel tank to the engine. See Figure 9-7.

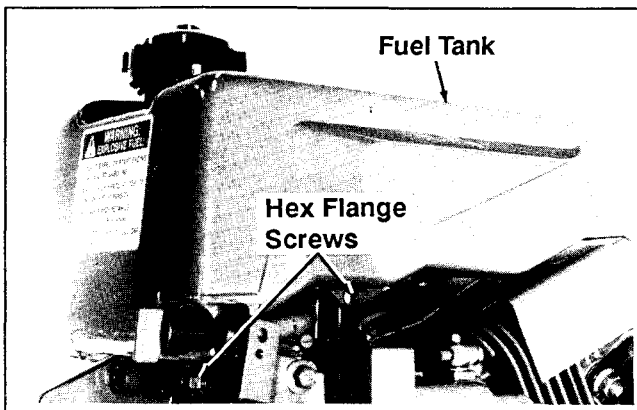

Figure 9-7. Removing Fuel Tank And Fuel Line.
(CH5 Fuel Tank Shown)

4. Remove the fuel tank and fuel line.

CONTROL PANEL REMOVAL (CH6 MODELS)

After the fuel tank has been removed, the control panel used on standard CH6 models can be disconnected and removed if this is needed for further disassembly.

REMOVE CARBURETOR AND LINKAGE

WARNING: Gasoline may be present in the carburetor and fuel system. Gasoline is extremely flammable, and its vapors can explode if ignited. Keep sparks, open flames, and other sources of ignition away from the engine.

1. Remove the throttle linkage from the throttle lever clip. See Figure 9-8.

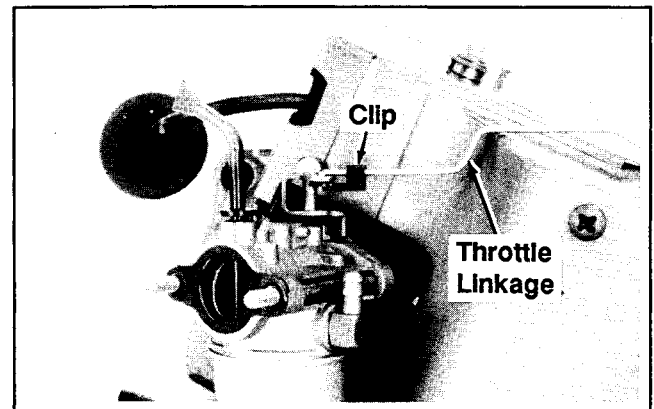

Figure 9-8. Removing Carburetor.
(CH5 Carburetor Shown)

2. Remove the carburetor and gasket from intake manifold studs.

REMOVE MUFFLER (CH5 MODELS)

1. Remove hex. flange nuts from exhaust studs and hex. flange screws from muffler bracket. See Figure 9-9.

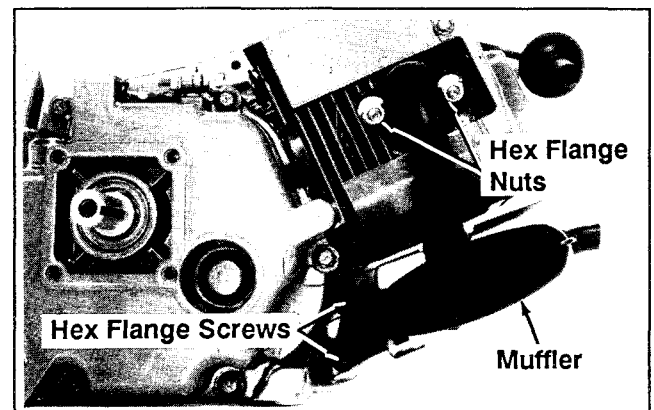

Figure 9-9. Removing Muffler.
(CH5 Shown)

SECTION 9 DISASSEMBLY

2. Remove muffler and gasket from exhaust outlet flange.

REMOVE MUFFLER (CH6 MODELS)

On most CH6 engines, the muffler is located under a heat shield on top of the cylinder barrel. The shield must be removed before the muffler can be removed. On these the muffler is attached to the exhaust port with two hex. flange nuts the same as CH5 models however the CH6 is also attached by a bracket to the cylinder head. Some CH6 models do not have the heat shield and use a flat "pancake" muffler which is secured to the exhaust port with two hex. head capscrews. Exhaust gaskets are always used between the muffler flange and exhaust port surface.

REMOVE BLOWER HOUSING AND BAFFLES

1. See Figures 9-10 and 9-11. Loosen four hex. flange screws and remove the cylinder head baffle. Do not remove the spark plug wire and grommet from the baffle until later if needed. Remove bottom baffle from underside of cylinder.

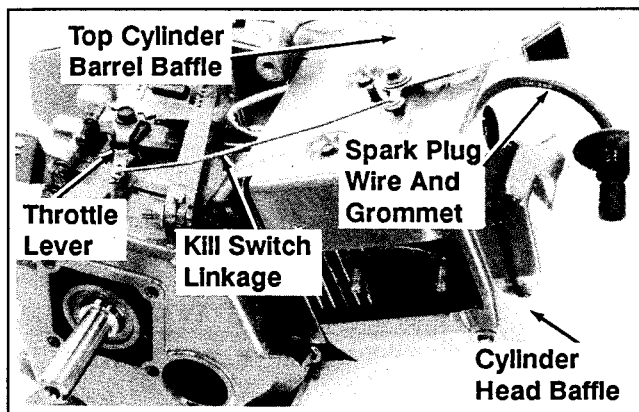

Figure 9-10. Removing Baffles.

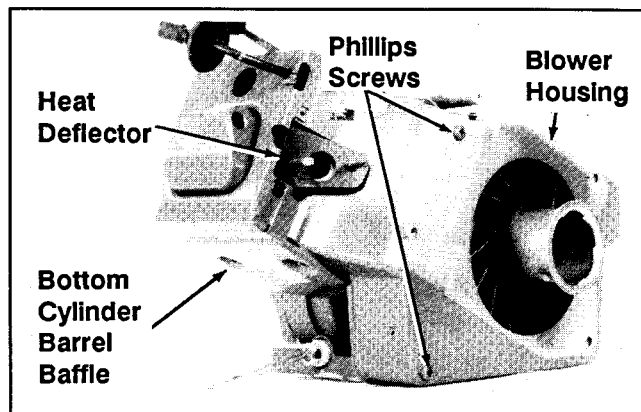

Figure 9-11. Removing Baffle And Blower Housing.

2. Remove hex. flange screws from the top cylinder barrel baffle. Remove the baffle and disconnect the kill switch linkage from the throttle lever.
3. Remove hex. flange screws from the bottom cylinder baffle. Remove the baffle.
4. Remove Phillips head screws from the blower housing. Remove the blower housing.
5. Remove the heat deflector and gaskets from the intake studs.

REMOVE GOVERNOR, THROTTLE, AND KILL SWITCH LINKAGE

1. See Figure 9-12. Loosen hex. flange nut on governor lever and remove lever from governor shaft. Disconnect return spring from the governor lever.

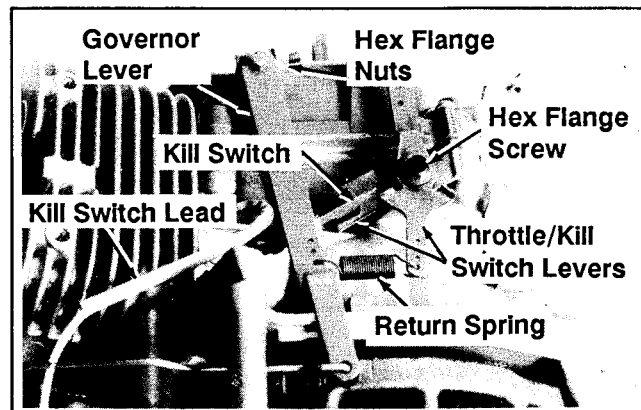

Figure 9-12. Removing Governor, Throttle, And Kill Switch Linkages

2. Disconnect the kill switch lead from the kill switch on engines so equipped.
3. Remove the hex. flange screw from the throttle/kill switch levers. (Not on constant speed model CH6.)
4. Remove throttle lever, bushing, and kill switch lever from engine.

REMOVE VALVE COVER AND CYLINDER HEAD

1. Remove the hex. flange screws from the valve cover. See Figure 9-13. Remove the valve cover from the cylinder head.

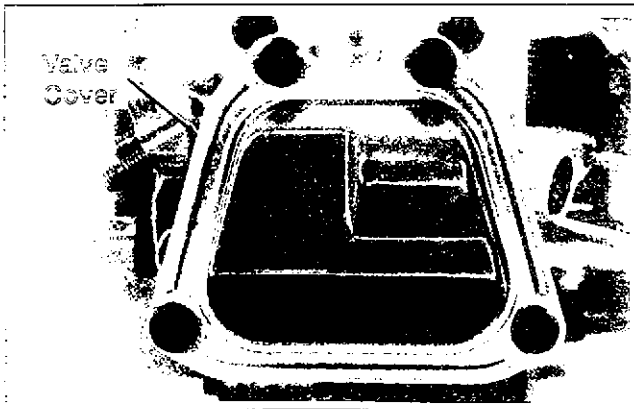

Figure 9-13. Removing Valve Cover.

2. Remove the breather assembly and valve cover gasket from the cylinder head. See Figure 9-14.

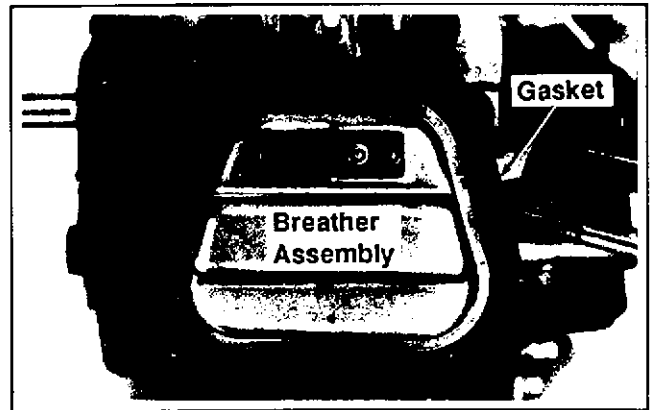

Figure 9-14. Removing Breather Assembly.

3. Remove the hex. flange screws, cylinder head, push rods*, and cylinder head gasket. See Figures 9-15 and 9-16.

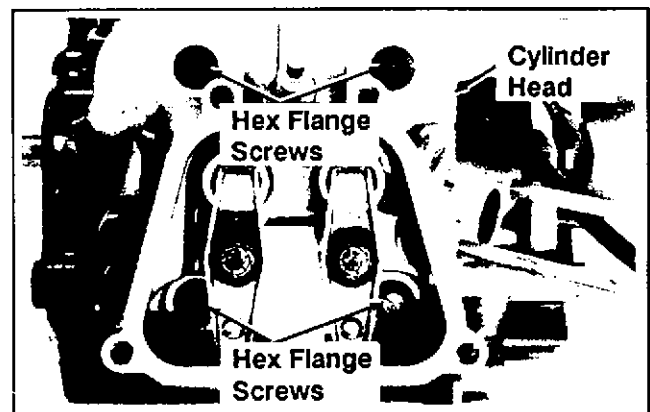

Figure 9-15. Removing Cylinder Head.

***NOTE:** Mark push rods so they will be reinstalled in same location.

SECTION 9 DISASSEMBLY

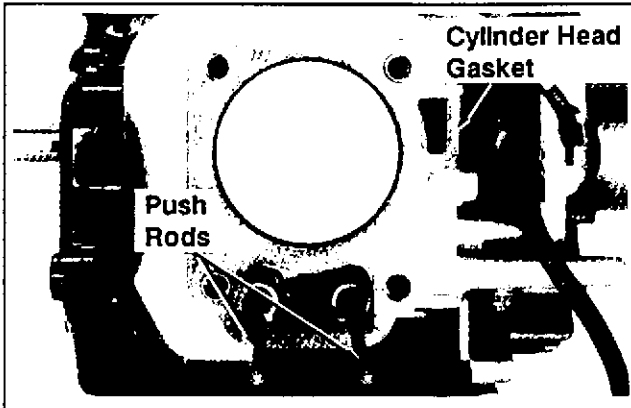

Figure 9-16. Removing Cylinder Head Gasket.

Disassemble Cylinder Head

1. Remove the spark plug. See Figure 9-17.

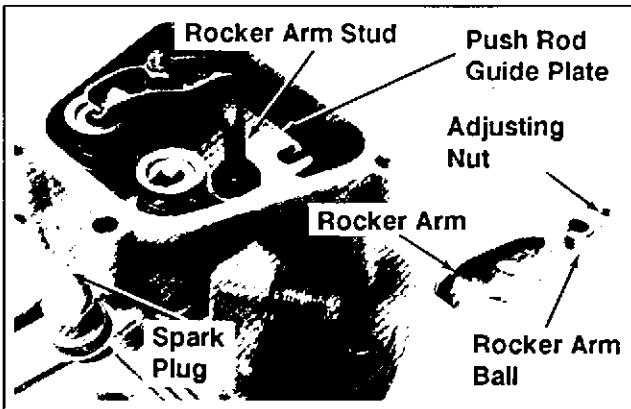

Figure 9-17. Removing Spark Plug And Rocker Arms.

2. Remove the valves:
 - a. Compress the valve springs by pushing down on the valve spring cap. See Figure 9-18.
 - b. Remove the valve spring caps, valve springs, and valves.

NOTE: Step 3 should only be done if further service on the cylinder head is necessary.

3. Remove the rocker arm adjusting nuts, rocker arms and balls, rocker arm studs, and push rod guide plate.

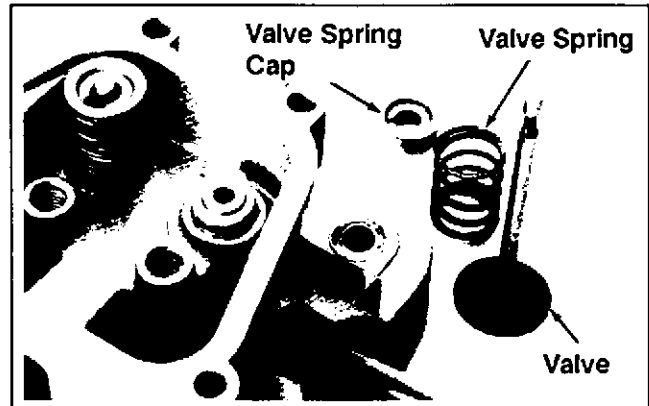

Figure 9-18. Removing Valves.

REMOVE IGNITION MODULE

1. Position the flywheel so the magnet is away from the ignition module.
2. Remove the hex. flange screws securing the ignition module to the crankcase. See Figure 9-19.

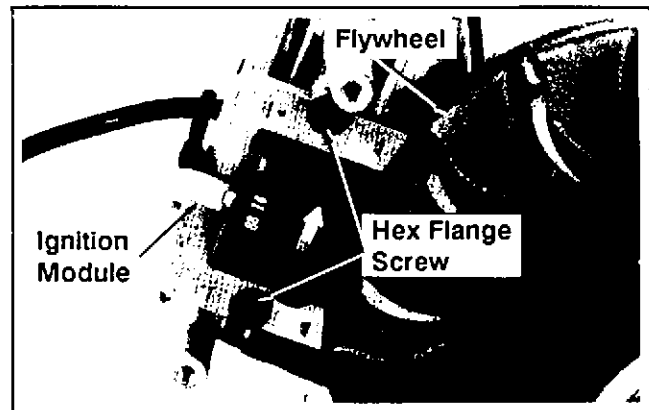

Figure 9-19. Removing Ignition Module.

REMOVE FLYWHEEL

NOTE: Always use a flywheel strap wrench to hold the flywheel when loosening or tightening the flywheel retaining fastener. Do not use any type of bar or wedge between the cooling fins as the fins could be cracked or damaged.

NOTE: Always use a puller to remove the flywheel from the crankshaft. Do not strike the flywheel or crankshaft, as these parts could be cracked or damaged.

1. Remove the hex. flange screw, plain washer, and drive cup. See Figures 9-20 and 9-21.

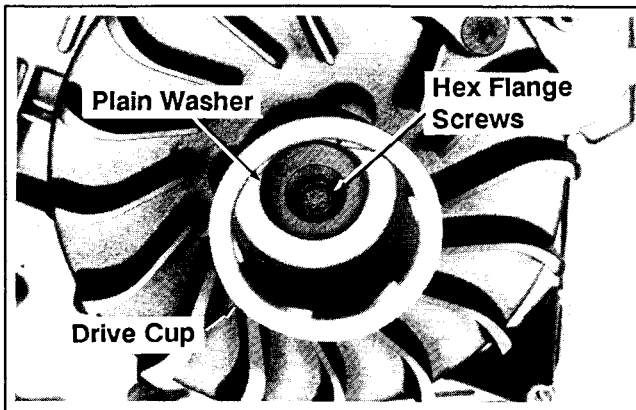

Figure 9-20. Removing Flywheel.

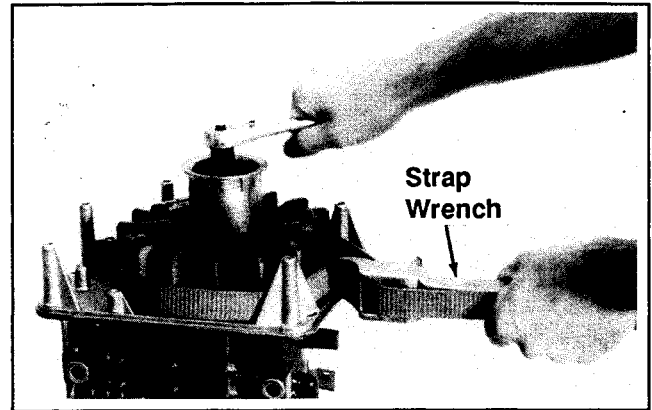

Figure 9-21. Removing Flywheel Fastener Using Strap Wrench.

2. Remove the flywheel from the crankshaft using a puller. See Figure 9-22.

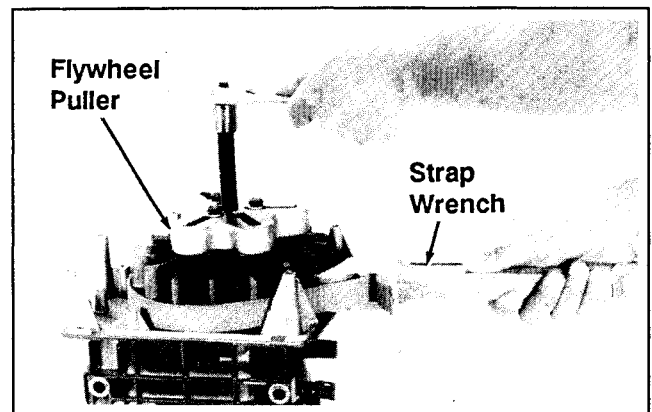

Figure 9-22. Removing Flywheel Using A Puller.

REMOVE CLOSURE PLATE

1. Remove the six hex. flange screws securing the closure plate to the crankcase. See Figure 9-23.

SECTION 9 DISASSEMBLY

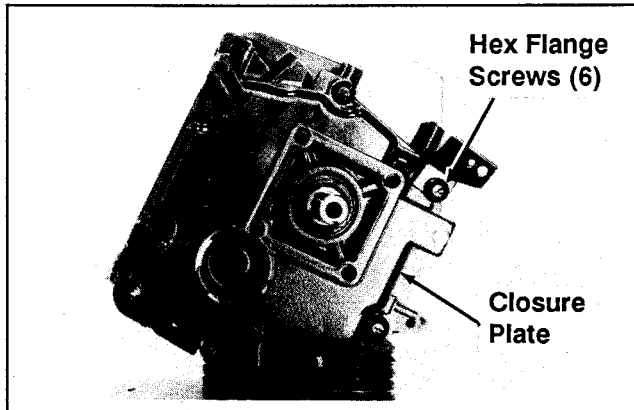

Figure 9-23. Removing Closure Plate.

2. Locate the splitting tabs in the seam of the closure plate and crankcase. Pry the closure plate from the crankcase using a large, flat-blade screwdriver. See Figure 9-24.

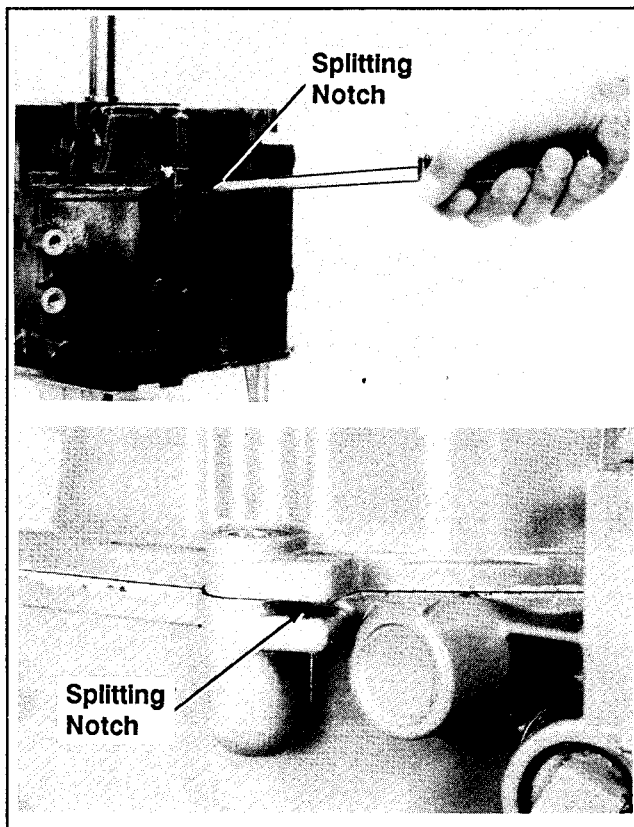

Figure 9-24. Splitting The Closure Plate/Crankcase.

NOTE: Insert the screwdriver only in the splitting tabs. Do not pry on the gasket surfaces of the crankcase or closure plate as this can cause leaks.

REMOVE CAMSHAFT AND TAPPETS

1. Align the timing marks on the camshaft and crankshaft. Remove the camshaft. See Figure 9-25.

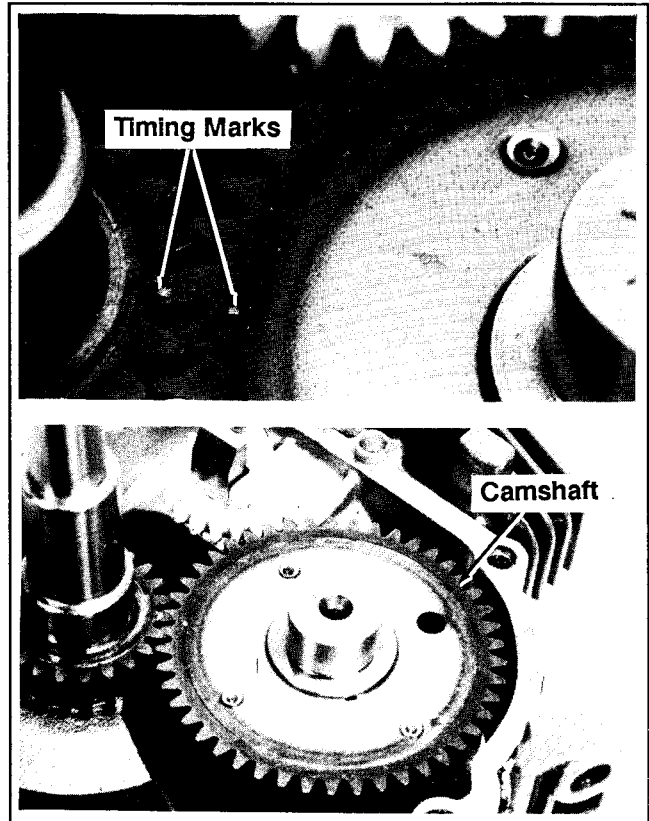

Figure 9-25. Removing Camshaft.

2. Mark the tappets as either intake or exhaust. See Figure 9-26.

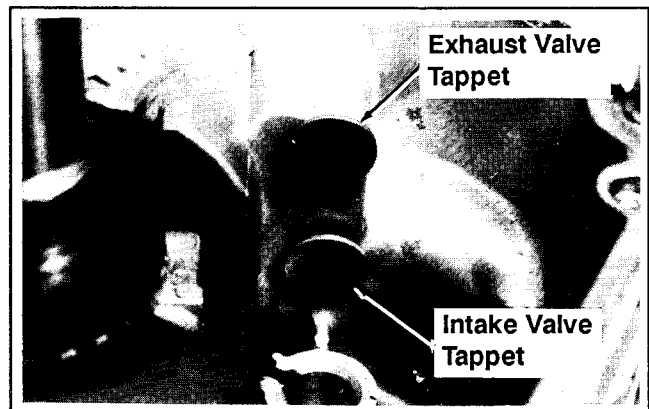

Figure 9-26. Removing Tappets.

NOTE: The intake tappet is the one farthest from the crankcase gasket surface. The exhaust tappet is nearest to the crankcase gasket surface.

REMOVE GOVERNOR GEAR AND CROSS SHAFT

1. Remove the governor gear and plain washer from the governor shaft. See Figure 9-27.

NOTE: Steps 2 and 3 should only be done only if further service is necessary.

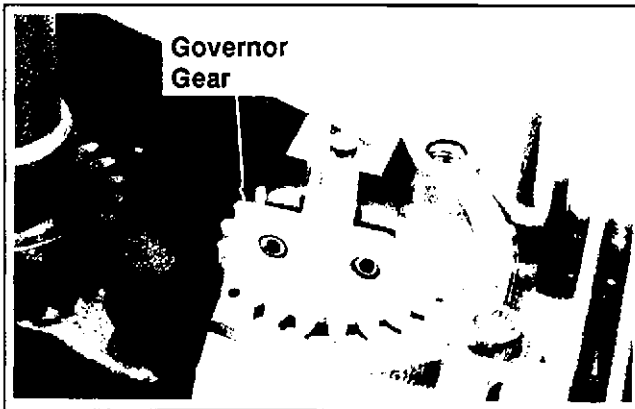

Figure 9-27. Removing Governor Gear.

2. Remove the snap ring and plain washer from the governor cross shaft. See Figure 9-28.

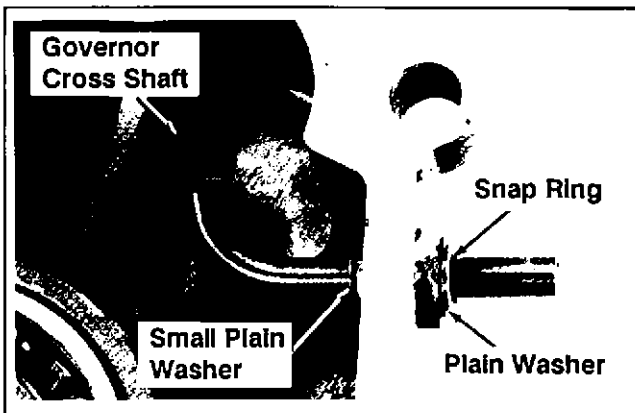

Figure 9-28. Removing Governor Cross Shaft.

3. Remove the governor cross shaft and small plain washer from the closure plate.

REMOVE OIL SENTRY™ (Optional)

1. Remove hex. flange screw and oil sentry float switch baffle on engines so equipped. See Figure 9-29.

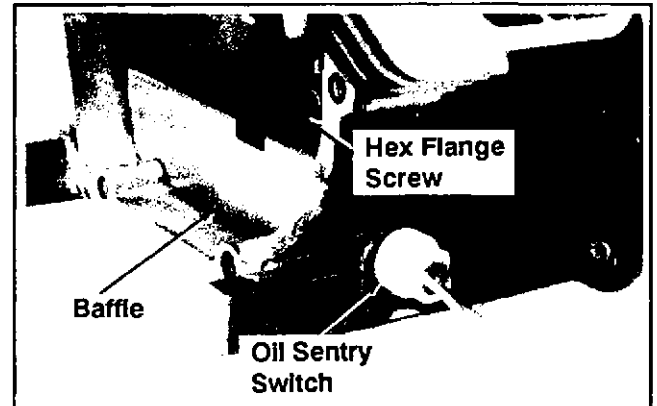

Figure 9-29. Removing Oil Sentry.

2. Use a rubber band to hold float switch.
3. Remove oil sentry float switch from crankcase.

REMOVE CONNECTING ROD AND THE PISTON

1. Remove the two hex. flange screws and connecting rod cap. See Figure 9-30.

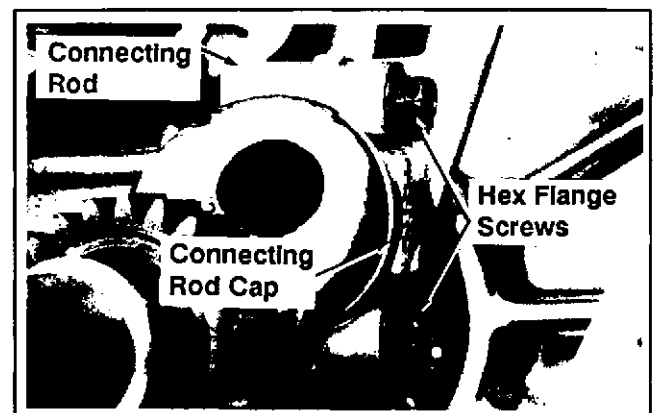

Figure 9-30. Removing Connecting Rod And Piston.

NOTE: If a carbon ridge is present at the top of the bore, use a ridge reamer tool to remove it before attempting to remove the piston.

SECTION 9 DISASSEMBLY

- Carefully push the connecting rod and piston away from the crankshaft and out of the cylinder bore.

REMOVE PISTON FROM CONNECTING ROD

- Remove the wrist pin retainer and the wrist pin. Separate the piston from the connecting rod. See Figure 9-31.

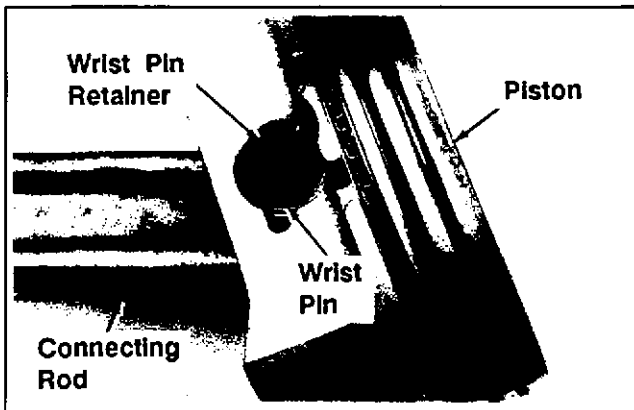

Figure 9-31. Removing Piston From Connecting Rod.

REMOVE PISTON RINGS

- Remove the top and center compression rings using a ring expander tool. See Figure 9-32.

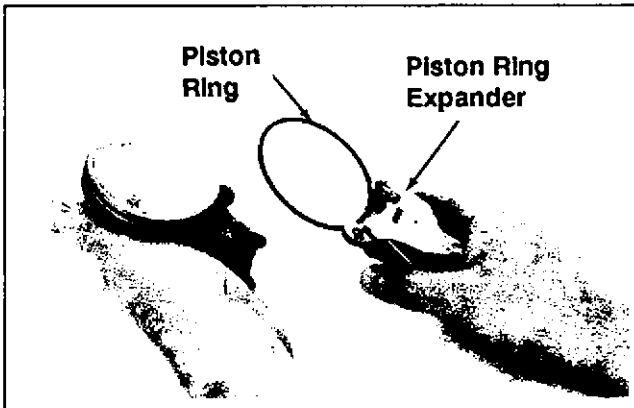

Figure 9-32. Removing Piston Rings.

- Remove the oil control ring rails, then remove the rails spacer.

REMOVE CRANKSHAFT

- Remove the woodruff key from the flywheel taper end of the crankshaft.
- On models with ball bearings, press the crankshaft from the crankcase. See Figure 9-33. Note: The crankshaft can be lifted out on those (CH6 models) using sleeve bearing instead of ball bearings.

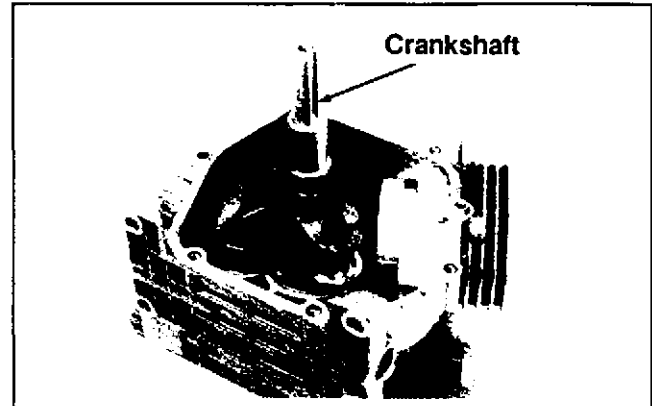

Figure 9-33. Removing Crankshaft.

REMOVE CRANKSHAFT OIL SEALS AND BEARINGS

- Remove the oil seals from the crankcase and closure plate. See Figure 9-34.

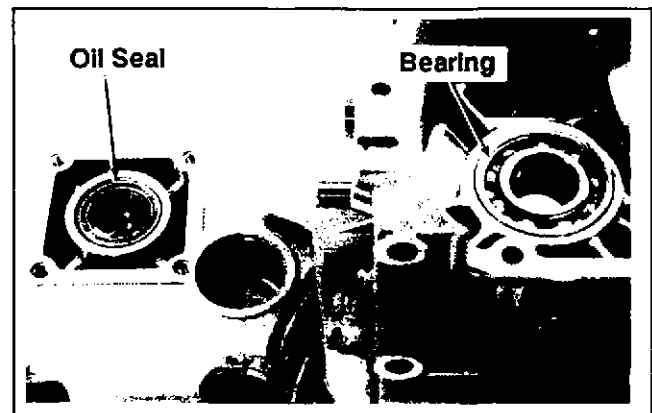

Figure 9-34. Removing Crankshaft Oil Seals And Bearings.*

- Remove the bearings from the crankcase and closure plate.

*NOTE: Ball bearing shown – some CH6 models use sleeve bearings instead of ball bearings. (See page 1.11 for tolerances.)

SECTION 10

INTERNAL COMPONENTS

This section covers the operation, inspection, and repair/reconditioning of major internal engine components. The following components are not covered in this section. They are covered in sections of their own:

Air Cleaner, Section 4
 Carburetor & External Governor, Section 5
 Retractable Starter, Section 7
 Ignition, Charging, & Electric Starter, Section 8

Clean all parts thoroughly. Only clean parts can be accurately inspected and gauged for wear or damage. There are many commercially available cleaners that will quickly remove grease, oil, and grime from engine parts. When such a cleaner is used, follow the manufacturer's instructions and safety precautions carefully.

Make sure all traces of the cleaner are removed before the engine is reassembled and placed into operation. Even small amounts of these cleaners can quickly break down the lubricating properties of engine oil.

Refer to A Guide To Engine Rebuilding (TP-2150) for additional information. Measurement Guide (TP-2159-A) and Engine Inspection Data Record (TP-2435) are also available; use these to record inspection results.

10

AUTOMATIC COMPRESSION RELEASE (ACR)

These engines are equipped with an **Automatic Compression Release (ACR)** mechanism. ACR lowers compression at cranking speeds to make starting easier.

Operation

The ACR mechanism consists of two flyweights and a spring attached to the gear on camshaft. When the engine is rotating at low cranking speeds (600 RPM or lower) the flyweights are held inward by the spring. In this position, the tab on the larger flyweight protrudes above the exhaust cam lobe. This lifts the exhaust

valve off of its seat during the first part of the compression stroke. The reduced compression results in an effective compression ratio of about 2:1 during cranking.

After the engine speed increases to about 600 RPM, centrifugal force moves the flyweights outward. In this position the tab on the larger flyweight drops into the recess in the exhaust cam lobe. When in the recess, the tab has no effect on the exhaust valve and the engine operates at full compression and full power.

When the engine is stopped, the spring returns the lever and control pin assembly to the compression release position ready for the next start.

SECTION 10

INTERNAL COMPONENTS

Benefits

Because of the reduced compression at cranking speeds, several important benefits are obtained:

1. Manual (retractable) starting is much easier. Without ACR, manual starting would be virtually impossible.
2. Electric start models can use a starter and battery size that are practical for the applications in which these engines are used.
3. ACR eliminates the need for a spark retard/advance mechanism. A spark retard/advance mechanism would be required on engines without ACR to prevent the "kickback" that would occur during starting. ACR eliminates this "kickback" making manual starting safer.
4. The choke control setting is less critical with ACR. In the event of flooding, excess fuel is blown out the opened exhaust valve and does not hamper starting.
5. Engines with ACR start much faster in cold weather than engines without ACR.
6. Engines with ACR can be started with spark plugs that are worn or fouled. Engines without ACR probably could not be started with those same spark plugs.

CAMSHAFT

Inspection And Service

Inspect the gear teeth of the camshaft. If the teeth are badly worn, chipped, or some are missing, replacement of the camshaft will be necessary.

CRANKSHAFT

Inspection And Service

Inspect the gear teeth of the crankshaft. If the teeth are badly worn, chipped, or some are missing, replacement of the crankshaft will be necessary.

Inspect the crankshaft bearings for scoring, grooving, etc. Do not replace bearings unless they show signs

of damage or are out of running clearance specifications. If the crankshaft turns easily and noiselessly, and there is no evidence of scoring, grooving, etc., on the races or bearing surfaces, the bearings can be reused. Note: Some CH6 use sleeve bearings rather than ball bearings. Refer to page 1.11 for wear tolerances.

Inspect the crankshaft keyways. If worn or chipped, replacement of the crankshaft will be necessary.

Inspect the crankpin for score marks or metallic pickup. Slight score marks can be cleaned with crocus cloth soaked in oil. If wear limits, as stated in "Specifications and Tolerances" are exceeded, it will be necessary to either replace the crankshaft or regrind the crankpin to 0.25 mm (0.010 in.) undersize. If reground, a 0.25 mm (0.010 in.) undersize connecting rod (big end) must then be used to achieve proper running clearance. Measure the crankpin for size, taper, and out-of-round.

NOTE: If the crankpin is reground, visually check to insure that the fillet blends smoothly with the crankpin surface. See Figure 10-1.

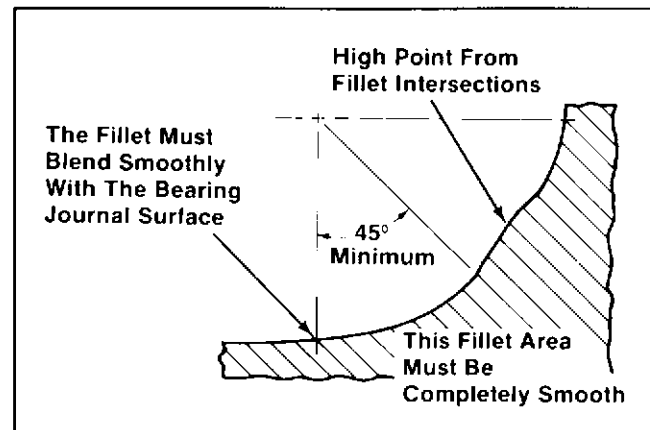

Figure 10-1. Crankpin Fillets.

CRANKCASE

Inspection And Service

Check all gasket surfaces to make sure they are free of gasket fragments. Gasket surfaces must also be free of deep scratches or nicks.

Check the cylinder bore wall for scoring. In severe cases, unburned fuel can cause scuffing and scoring of the cylinder wall, it washes the necessary lubricat-

ing oils off the piston and cylinder wall. As raw fuel seeps down the cylinder wall, the piston rings make metal to metal contact with the wall. Scoring of the cylinder wall can also be caused by localized hot spots resulting from blocked cooling fins or from inadequate or contaminated lubrication.

If the cylinder bore is badly scored, excessively worn, tapered, or out of round, resizing is necessary. Use a measuring device (inside micrometer, etc.) to determine amount of wear (refer to the "Specifications, Tolerances, And Special Torque Values", in Section 1), then select the nearest suitable oversize of either **0.25 mm (0.010 in.)** or **0.50 mm (0.020 in.)**. Resizing to one of these oversizes will allow usage of the available oversize piston and ring assemblies. Initially, resize using a boring bar, then use the following procedures for honing the cylinder.

Honing

While most commercially available cylinder hones can be used with either portable drills or drill presses, the use of a low speed drill press is preferred as it facilitates more accurate alignment of the bore in relation to the crankshaft crossbore. Honing is best accomplished at a drill speed of about **250 RPM** and **60 strokes** per minute. After installing coarse stones in hone, proceed as follows:

1. Lower hone into bore and after centering, adjust so that the stones are in contact with the cylinder wall. Use of a commercial cutting-cooling agent is recommended.
2. With the lower edge of each stone positioned even with the lowest edge of the bore, start drill and honing process. Move the hone up and down while resizing to prevent the formation of cutting ridges. Check the size frequently.

NOTE: Keep in mind the temperatures caused by honing may cause inaccurate measurements. Make sure the bore is cool when measuring.

3. When the bore is within **0.064 mm (0.0025 in.)** of desired size, remove the coarse stones and replace with burnishing stones. Continue with the burnishing stones until within **0.013 mm**

(**0.0005 in.**) of desired size and then use finish stones (220–280 grit) and polish to final size. A crosshatch should be observed if honing is done correctly. The crosshatch should intersect at approximately **23–33°** off the horizontal. Too flat an angle could cause the rings to skip and wear excessively, too steep an angle will result in high oil consumption (refer to Figure 10-2.)

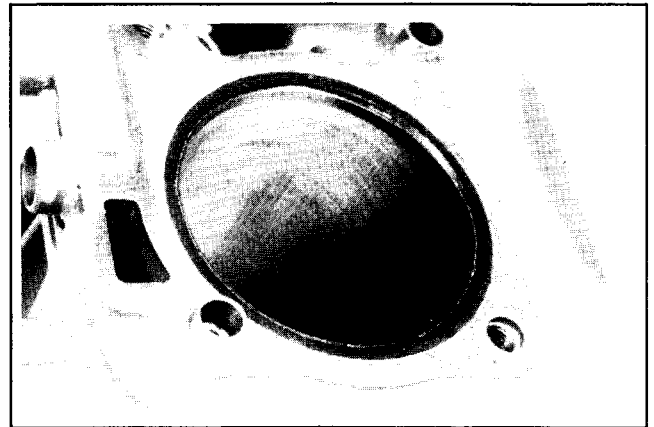

Figure 10-2. Cylinder Bore Crosshatch After Honing.

4. After resizing, check the bore for roundness, taper, and size. Use an inside micrometer, telescoping gauge, or bore gauge to take measurements. The measurements should be taken at three locations in the cylinder—at the top, middle, and bottom. Two measurements should be taken (perpendicular to each other) at each of the three locations.

Clean Cylinder Bore After Honing

Proper cleaning of the cylinder walls following boring and/or honing is very critical to a successful overhaul. Machining grit left in the cylinder bore can destroy an engine in less than one hour of operation after a rebuild.

The final cleaning operation should always be a thorough scrubbing with a brush and hot, soapy water. Use a strong detergent that is capable of breaking down the machining oil while maintaining a good level of suds. If the suds break down during cleaning, discard the dirty water and start again with more hot water and detergent. Following the scrubbing, rinse the cylinder with very hot, clear water, dry it completely, and apply a light coating of engine oil to prevent rusting.

SECTION 10

INTERNAL COMPONENTS

Measuring Piston-To-Bore Clearance

Before installing the piston into the cylinder bore, it is necessary that the clearance be accurately checked. This step is often overlooked, and if the clearances are not within specifications, engine failure will usually result.

NOTE: Do not use a feeler gauge to measure piston-to-bore clearance – it will yield inaccurate measurements. Always use a micrometer.

Use the following procedure to accurately measure the piston-to-bore clearance:

1. Use a micrometer and measure the diameter of the piston **6 mm (0.24 in.)** above the bottom of the piston skirt and perpendicular to the piston pin (see Figure 10-3.)

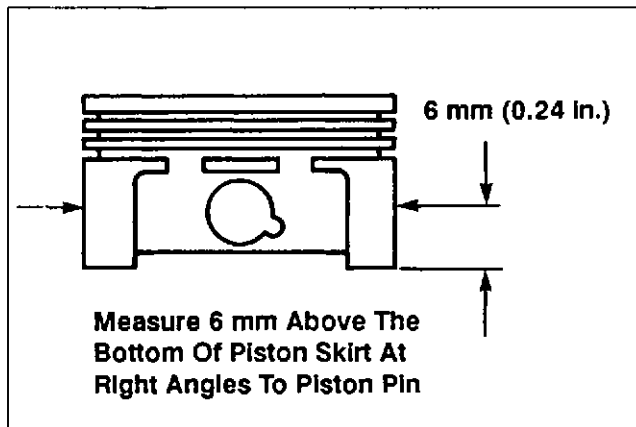

Figure 10-3. Measuring Piston Diameter.

2. Use an inside micrometer, telescoping gauge, or bore gauge and measure the cylinder bore. Take the measurement approximately **40 mm (1.6 in.)** below the top of the bore and perpendicular to the piston pin.
3. Piston-to-bore clearance is the difference between the bore diameter and the piston diameter (Step 2 minus Step 1).

FLYWHEEL

Inspection

Inspect the flywheel for cracks, and the flywheel keyway for damage. Replace flywheel if cracked. Replace the flywheel, the crankshaft, and the key if flywheel key is sheared or the keyway damaged.

Inspect the ring gear for cracks or damage. Kohler does not provide ring gears as a serviceable part. Replace the flywheel if the ring gear is damaged.

CYLINDER HEAD AND VALVES

Inspection And Service

Carefully inspect the valve mechanism parts. Inspect the valve springs and related hardware for excessive wear or distortion. Check the valves and valve seat area or inserts for evidence of deep pitting, cracks, or distortion. Check clearance of the valve stems in guides. See Figure 10-4 for valve details and specifications.

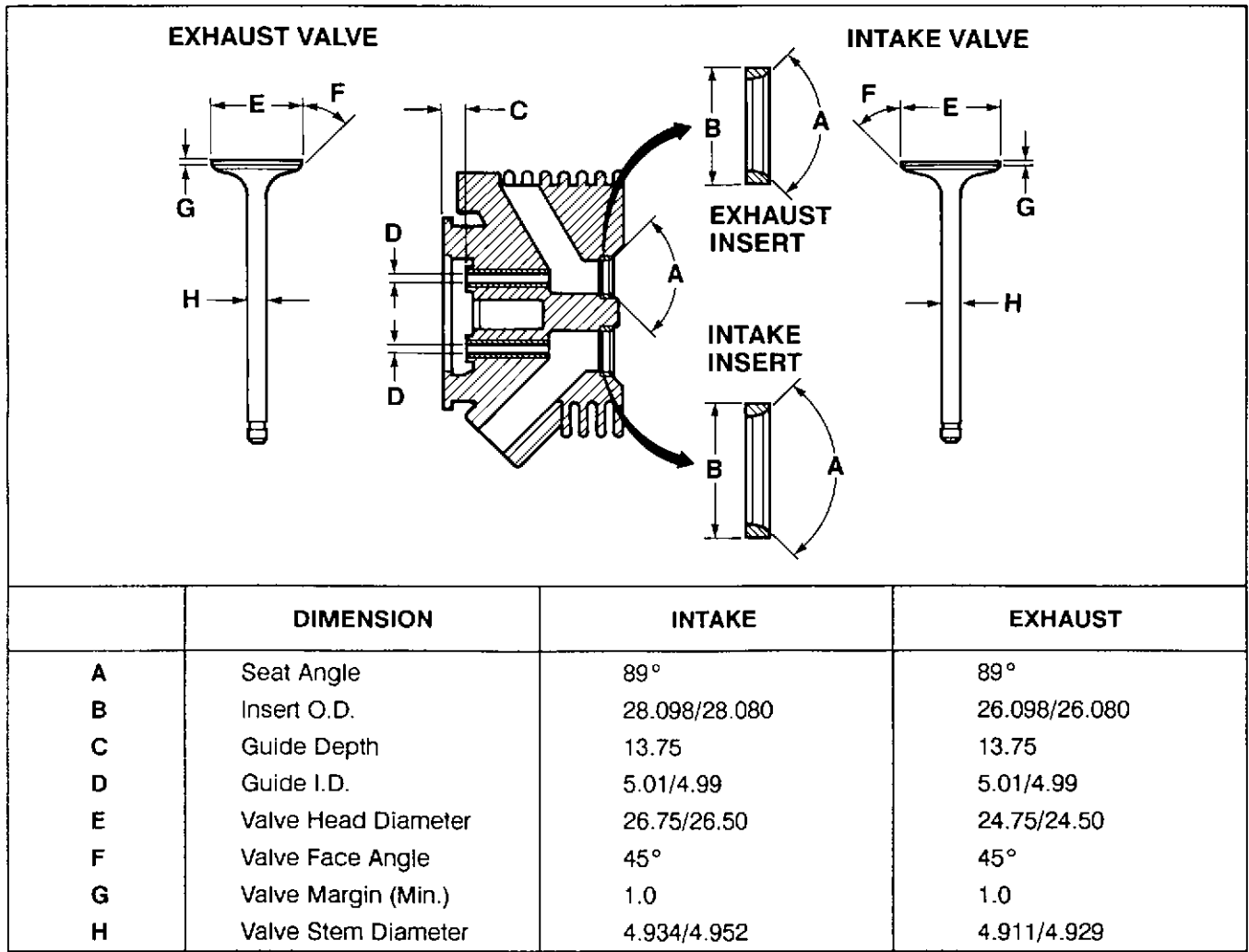
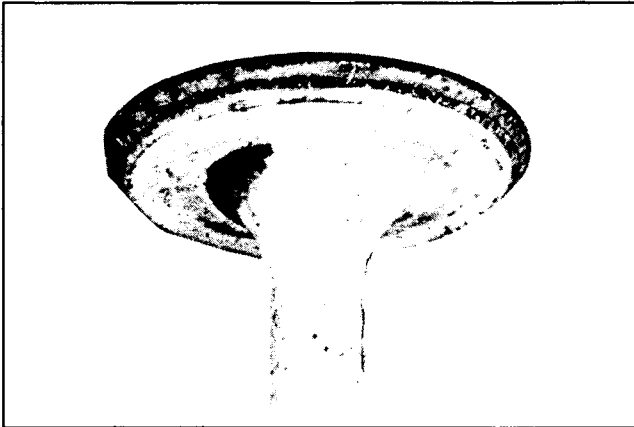

Figure 10-4. Valve Details

Hard starting, or loss of power accompanied by high fuel consumption may be symptoms of faulty valves. Although these symptoms could also be attributed to worn rings, remove and check the valves first. After removal, clean the valve heads, faces, and stems with

a power wire brush. Then, carefully inspect each valve for defects such as warped head, excessive corrosion, or worn stem end. Replace valves found to be in bad condition. A normal valve and valves in bad condition are shown in the accompanying illustrations.

SECTION 10 INTERNAL COMPONENTS



Normal: Even after long hours of operation a valve can be reconditioned and reused if the face and margin are in good shape. If a valve is worn to where the margin is less than 1/32" do not reuse it. The valve shown was in operation for almost 1000 hours under controlled test conditions.

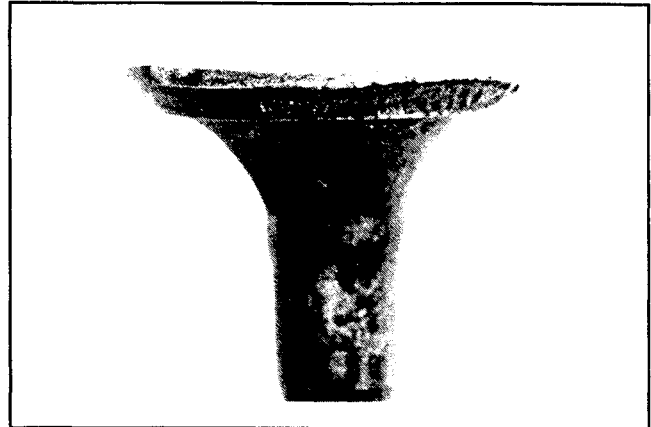

Leakage: A poor grind on face or seat of valve will allow leakage resulting in a burned valve on one side only.

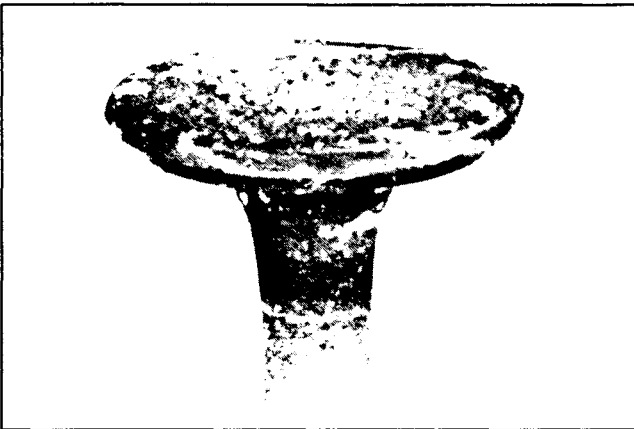

Bad Condition: The valve depicted here should be replaced. Note the warped head; margin damaged and too narrow. These conditions could be attributed to excessive hours or a combination of poor operating conditions.

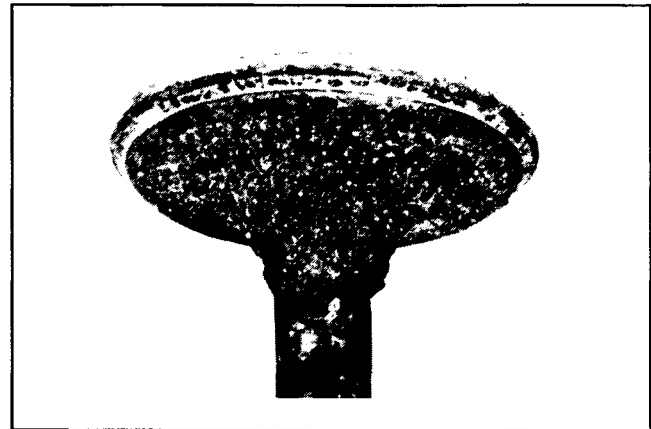

Coking: Coking is normal on intake valves and is not harmful. If the seat is good, the valve could be reused after cleaning.

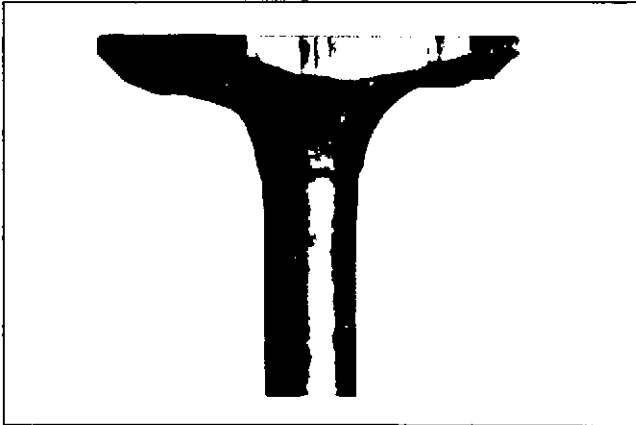

Carbon Cut: Excessive buildup of deposits in the combustion chamber may result in valve damage because deposits can become hard enough to cut the valve. Cleaning of the cylinder head at proper intervals could prevent such damage.

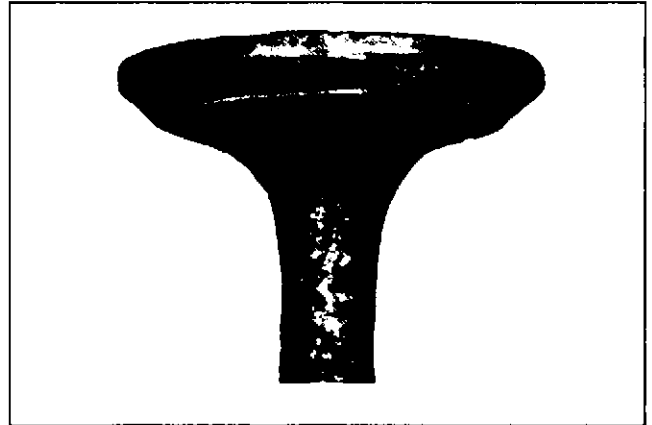

Stem Corrosion: Moisture in fuel or from condensation are the most common causes of valve stem corrosion. Condensation occurs from improper preservation during storage and when engine is repeatedly stopped before it has a chance to reach normal operating temperatures. Replace corroded valves.

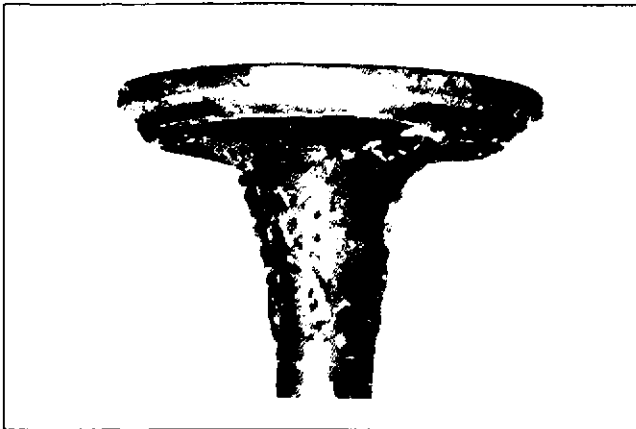

Gum: Gum deposits usually result from using stale gasoline. This condition is often noted in applications where fuel is not drained out of tank during the off season. Gum is a prevalent cause of valve sticking. The cure is to ream the valve guides and clean or replace the valves, depending on their condition.

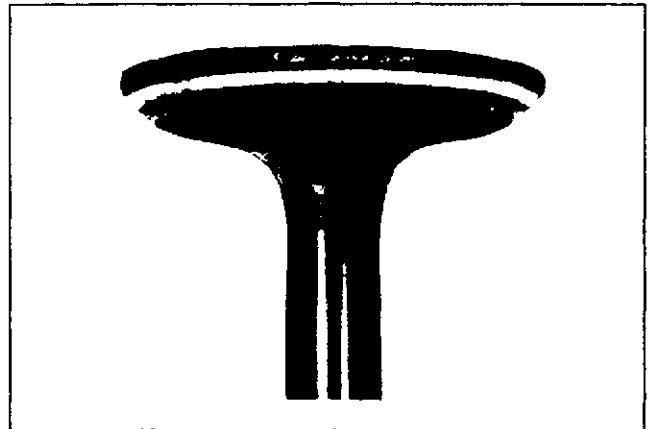

Overheating: An exhaust valve subject to overheating will have a dark discoloration in the area above the valve guide. Worn guides and faulty valve springs may cause this condition. Also check for clogged air intake, blocked fins, and lean fuel mixture when this condition is noted.

SECTION 10

INTERNAL COMPONENTS

Valve Guides

If a valve guide is worn beyond specifications, it will not guide the valve in a straight line. This may result in burnt valve faces or seats, loss of compression, and excessive oil consumption.

To check valve guide-to-valve stem clearance, thoroughly clean the valve guide and, using a split-ball gauge, measure the inside diameter. Then, using an outside micrometer, measure the diameter of the valve stem at several points on the stem where it moves in the valve guide. Use the largest stem diameter to calculate the clearance. If the clearance exceeds **0.085 mm (0.00335 in.)** on intake valve or **0.080 mm (0.00315 in.)** on exhaust valve, determine whether the valve stem or the guide is responsible for the excessive clearance.

Maximum allowable inside diameter is **5.085 mm (0.2002 in.)** on the intake valve guide and **5.080 mm (0.2000 in.)** on the exhaust valve guide.

If the valve stem diameter is within specifications, then recondition the valve guide as needed.

Reconditioning Valve Guide

The valve guides in the cylinder head are not removable. Use a **0.25 mm (0.010 in.) O/S reamer**. Tool no. **KO-1033**.

Valve Seat Inserts

The valve seats are not replaceable. If the seats become badly pitted, cracked, or distorted, the inserts can be reconditioned.

Use a standard valve seat cutter (see Figure 10-5) and cut seat to dimensions shown in Figure 10-4. (Valve details illustration).

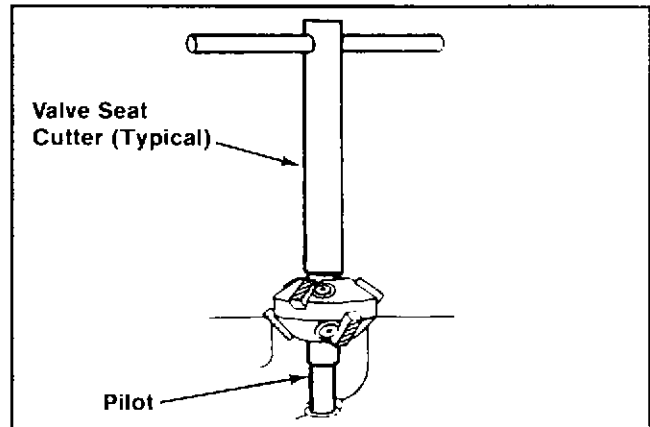

Figure 10-5. Standard Valve Seat Cutter.

Lapping Valves

Reground or new valves must be lapped in, to provide fit. Use a hand valve grinder with suction cup for final lapping. Lightly coat valve face with "fine" grade of grinding compound, then rotate valve on seat with grinder. Continue grinding until smooth surface is obtained on seat and on valve face. Thoroughly clean cylinder head in soap and hot water to remove all traces of grinding compound. After drying cylinder head, apply a light coating of **SAE 10** oil to prevent rusting.

PISTONS AND RINGS

Inspection

Scuffing and scoring of pistons and cylinder walls occurs when internal temperatures approach the welding point of the piston. Temperatures high enough to do this are created by friction, which is usually attributed to improper lubrication, and/or overheating of the engine.

Normally, very little wear takes place in the piston boss-piston pin area. If the original piston and connecting rod can be reused after new rings are installed, the original pin can also be reused but new piston pin retainers are required. The piston pin is included as part of the piston assembly – if the piston pin or the pin boss of the piston is worn or damaged, a new piston assembly is required.

Ring failure is usually indicated by excessive oil consumption and blue exhaust smoke. When rings fail, oil is allowed to enter the combustion chamber where it is burned along with the fuel. High oil consumption can also occur when the piston ring end gap is incorrect because the ring cannot properly conform to the cylinder wall under this condition. Oil control is also lost when ring gaps are not staggered during installation.

When cylinder temperatures get too high, lacquer and varnish collect on pistons causing rings to stick, which results in rapid wear. A worn ring usually takes on a shiny or bright appearance. Scratches on rings and

pistons are caused by abrasive material such as carbon, dirt, or pieces of hard metal.

Detonation damage occurs when a portion of the fuel charge ignites spontaneously from heat and pressure shortly after ignition. This creates two flame fronts which meet and explode to create extreme hammering pressures on a specific area of the piston. Detonation generally occurs from using fuels with an octane rating that is too low.

Preignition, or ignition of the fuel charge before the timed spark, can cause damage similar to detonation. Preignition damage is often more severe than detonation damage – often a hole is quickly burned right through the piston dome. Preignition is caused by a hot spot in the combustion chamber from sources such as: glowing carbon deposits, blocked fins, improperly seated valve, or wrong spark plug.

See Figure 10–6 for some common types of piston and ring damage.

CLOSURE PLATE AND CRANKCASE

1. Prepare the sealing surfaces of the closure plate and crankcase as directed by the sealant manufacturer.

NOTE: Do not scrape the surfaces when cleaning as this will damage the surfaces and could cause leaks. The use of a gasket-removing solvent is recommended.

SECTION 10 INTERNAL COMPONENTS

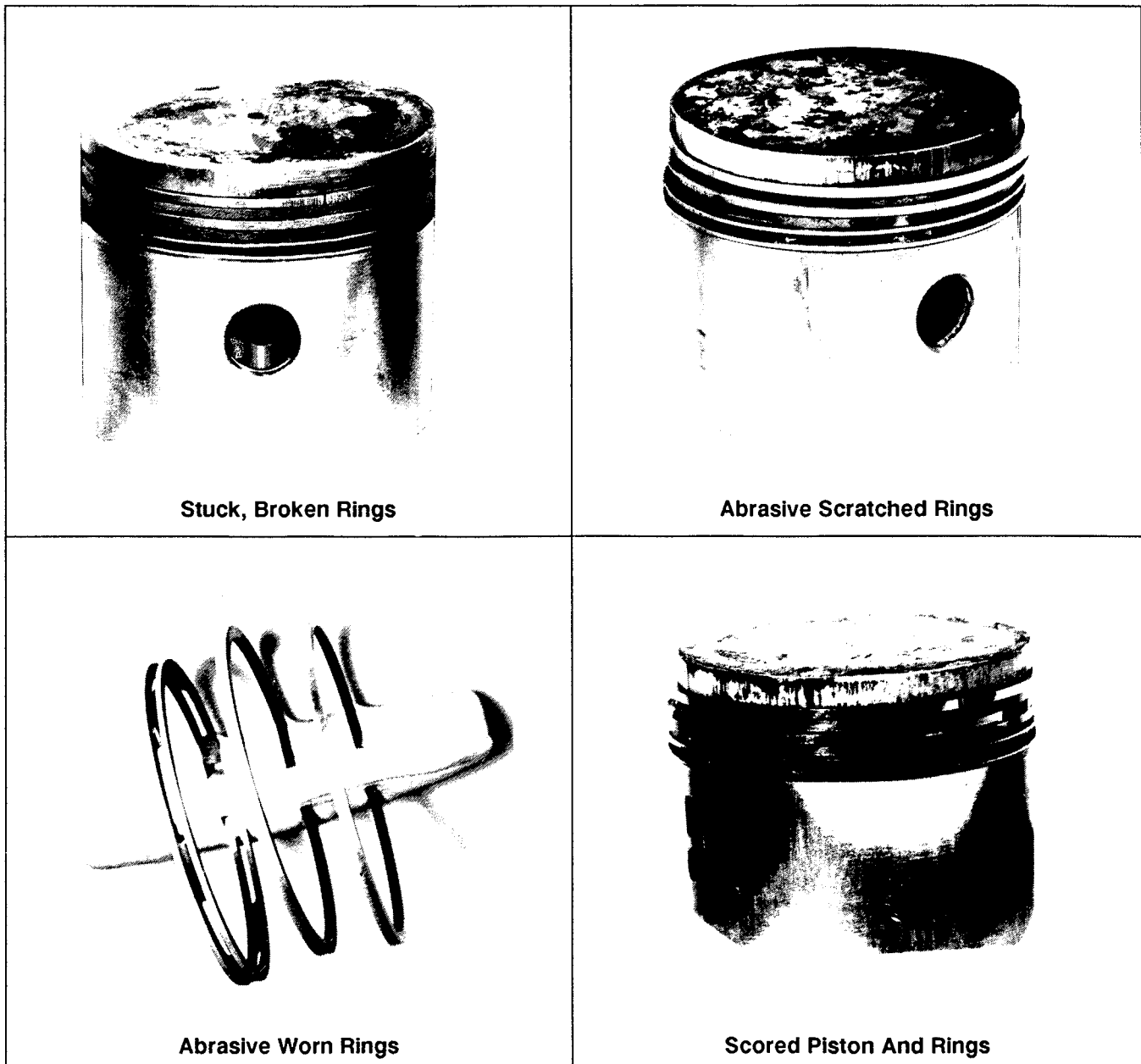

Figure 10-6. Common Types Of Piston And Ring Damage.

Replacement pistons are available in STD bore size, and in **0.25 mm (0.010 in.)** and **0.50 mm (0.020 in.)** oversizes. Replacement pistons include new piston ring sets and new piston pins.

Service replacement piston ring sets are also available separately for STD pistons, and for **0.25 mm (0.010 in.)** and **0.50 mm (0.020 in.)** oversized pis-

tons. Always use new piston rings when installing pistons. **Never reuse old rings.**

The cylinder bore must be deglazed before service ring sets are used.

Some important points to remember when servicing piston rings:

1. If the cylinder bore does not need reboring and if the old piston is within wear limits and free of score or scuff marks, the old piston may be reused.
2. Remove old rings and clean up grooves. **Never reuse old rings.**
3. Before installing the rings on piston, place the top two rings, each in turn, in its running area in cylinder bore and check end gap (see Figure 10-7.) This gap should be **0.75 mm (0.030 in.) max.** in a used cylinder bore and **0.25/0.45 mm (0.010/0.018 in.)** in a new cylinder bore.

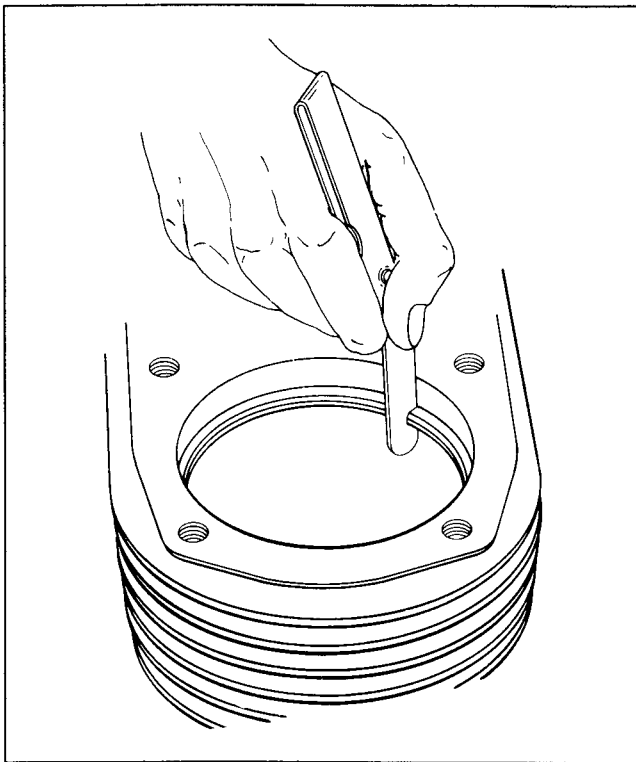

Figure 10-7. Measuring Piston Ring End Gap.

4. After installing the new rings on piston, check piston-to-ring side clearance. Maximum recommended side clearance is:

Top ring – **0.040/0.085 mm (0.0016/0.0033 in.)**
Middle ring – **0.040/0.072 mm (0.0016/0.0028 in.)**
Oil control ring – **0.140/0.275 mm (0.0055/0.0108 in.)**

If side clearance is greater than specified, a new piston **must** be used. Refer to Figure 10-8.

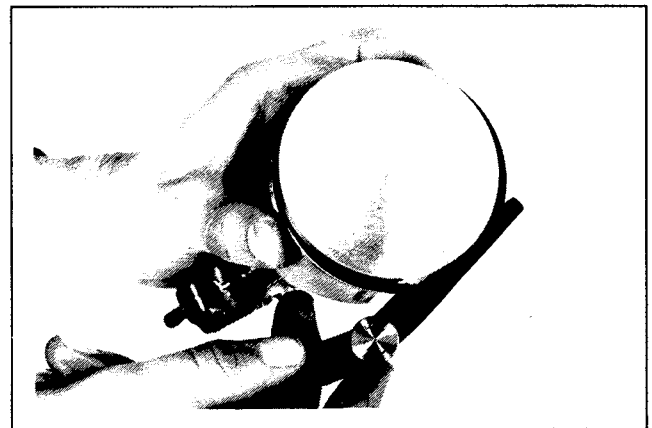

Figure 10-8. Measuring Piston Ring Side Clearance.

Install Piston Rings

To install piston rings, proceed as follows:

NOTE: Rings must be installed correctly. Ring installation instructions are usually included with new ring sets. Follow instructions carefully. Use a piston ring expander to install rings. Install the bottom (oil control) ring first and the top compression ring last. Refer to Figure 10-9.

SECTION 10 INTERNAL COMPONENTS

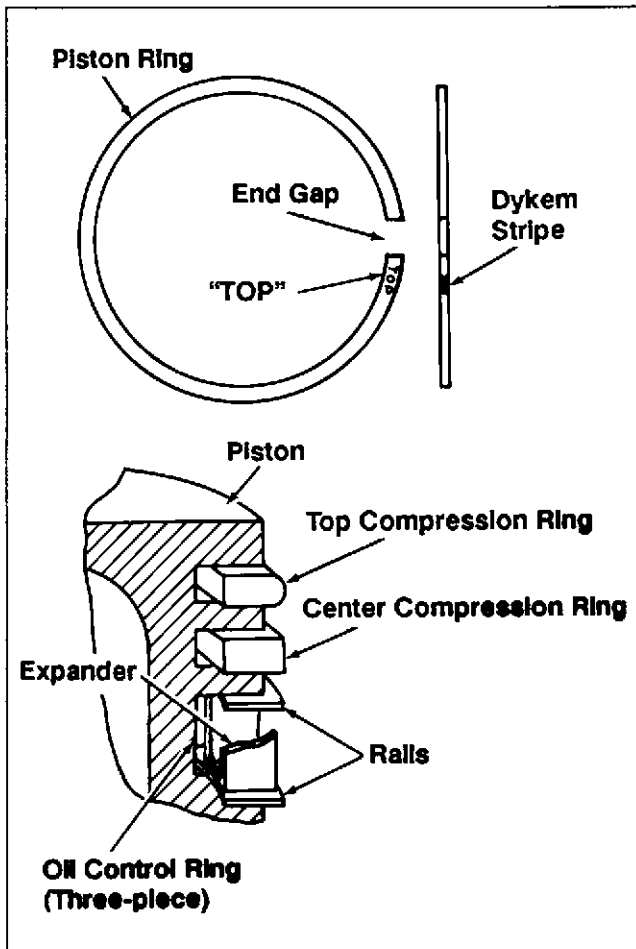

Figure 10-9. Piston Ring Installation.

1. Oil Control Ring (Bottom Groove): Install the expander and then the rails. Make sure the ends of expander are not overlapped.
2. Compression Ring (Center Groove): Install the center ring using a piston ring installation tool. Make sure the "top" mark is up and the PINK dykem stripe is to the left of end gap.

3. Compression Ring (Top Groove): Install the top ring using a piston ring installation tool. Make sure the "top" mark is up and the BLUE dykem stripe is to the left of end gap.

CONNECTING RODS

Inspection And Service

Check bearing area (big end) for excessive wear, score marks, running and side clearances (Refer to Section 1, "Specifications, Tolerances, And Special Torque Values"). Replace rod and cap if scored or excessively worn.

Service replacement connecting rods are available in STD crankpin size and **0.25 mm (0.010 in.)** under-size. The **0.25 mm (0.010 in.)** undersized rod can be identified by the drilled hole located in the lower end of the rod shank. Always refer to the appropriate parts information to ensure that correct replacements are used.

GOVERNOR GEAR

Inspection

Inspect the governor gear teeth. Look for any evidence of worn, chipped, or cracked teeth. If one or more of these problems is noted, replace the governor gear.

SECTION 11 REASSEMBLY

The following sequence is suggested for complete engine reassembly. This procedure assumes that all components are new or have been reconditioned, and all component subassembly work has been completed. This procedure may be varied to accommodate options or special equipment.

NOTE: Make sure the engine is assembled using all specified torque values, tightening sequences, and clearances. Failure to observe specifications could cause severe engine wear or damage.

Always use new gaskets.

TYPICAL REASSEMBLY SEQUENCE

1. Install crankshaft bearings.
2. Install crankshaft.
3. Install piston rings.
4. Install piston to connecting rod.
5. Install piston and connecting rod.
6. Install oil sentry.
7. Install governor gear and cross shaft.
8. Install tappets and camshaft.
9. Install closure plate.
10. Install crankshaft oil seals.
11. Install flywheel.
12. Install ignition module.
13. Install cylinder head and valve cover.
14. Install kill switch, throttle, and governor linkage.
15. Install baffles and blower housing.
16. Install muffler.
17. Install carburetor and linkage.
18. Install fuel tank and line.
19. Install dipstick and fill tube (CH5).
20. Install retractable starter.
21. Install air cleaner.
22. Prepare the engine for operation.

INSTALL CRANKSHAFT BEARINGS

1. Assemble the **NU-12018 bearing installer** to the **NU-4747 handle**. See Figure 11-1.



Figure 11-1. Installing Crankshaft Bearings.

2. Position the installer/bearing to the bearing bore of the crankcase or closure plate.
3. Drive the bearing into the bearing bore. Make sure the bearing is installed straight and true, and bottoms in the bore.

INSTALL CRANKSHAFT

1. Lubricate the flywheel end bearing surface of the crankshaft.
2. Insert the crankshaft through the flywheel end bearing on CH6 engines with sleeve bearings. If ball bearing used, the crankshaft must be pressed in. See Figure 11-2.

SECTION 11 REASSEMBLY

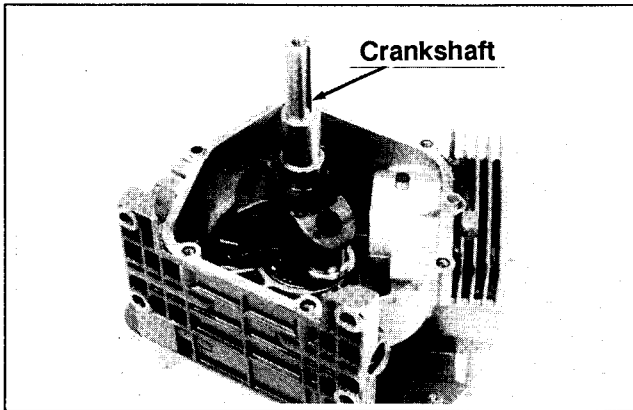

Figure 11-2. Installing Crankshaft.

INSTALL PISTON RINGS

NOTE: For detailed piston inspection procedures and piston ring installation, refer to Section 10 – “Internal Components”.

ASSEMBLE PISTON TO CONNECTING ROD

1. Assemble the piston, connecting rod, wrist pin and wrist pin retainers. See Figure 11-3.

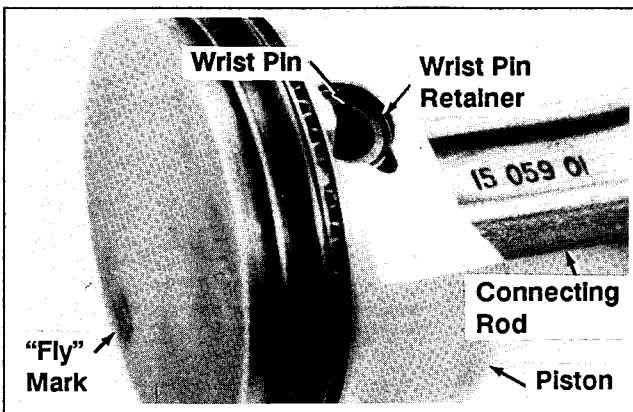

Figure 11-3. Installing Piston
To Connecting Rod.

NOTE: The connecting rod must be assembled so the side with the cast numbers is opposite the “FLY” mark on the piston.

INSTALL PISTON AND CONNECTING ROD

NOTE: Proper orientation of the piston/connecting rod inside the engine is extremely important. Improper orientation can cause extensive wear or damage.

1. Stagger the piston rings in the grooves until the end gaps are **120 degrees** apart.
2. Lubricate the cylinder bore, piston and rings with engine oil. Compress the piston rings using a piston ring compressor. See Figure 11-4.

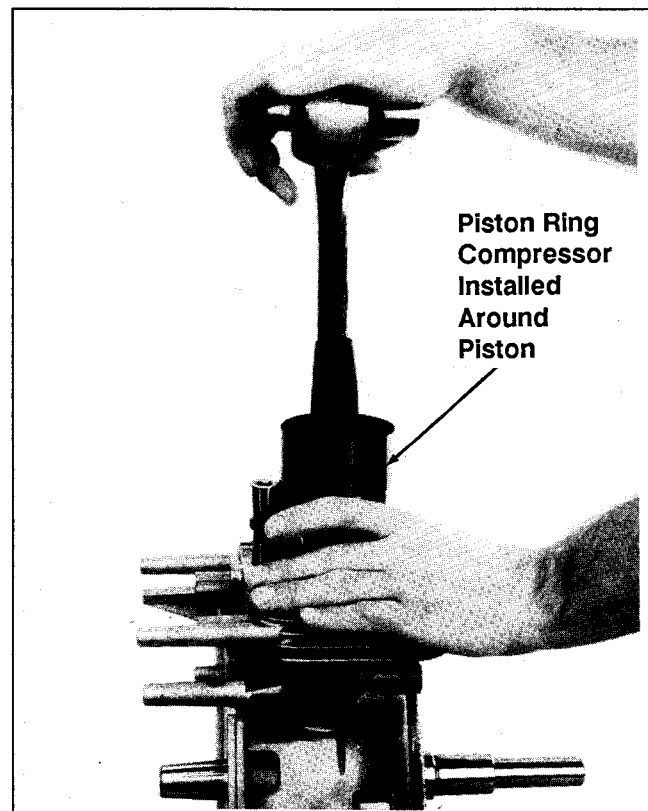

Figure 11-4. Installing Piston
And Connecting Rod.

3. Orient the “FLY” mark on piston towards the fly-wheel side of crankcase. See Figure 11-5. Gently push the piston/connecting rod into bore. **Do not pound on the piston.**

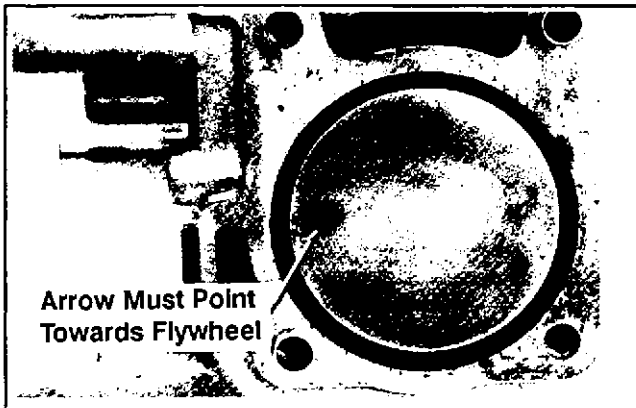

Figure 11-5. Piston Installation Identifier.

4. Lubricate the crankshaft journal and connecting rod bearing surfaces with engine oil. Install the connecting rod cap to the connecting rod. See Figure 11-6.

NOTE: The connecting rod cap must be installed with its match mark aligned with the connecting rod match mark. Improper installation can cause serious engine damage.

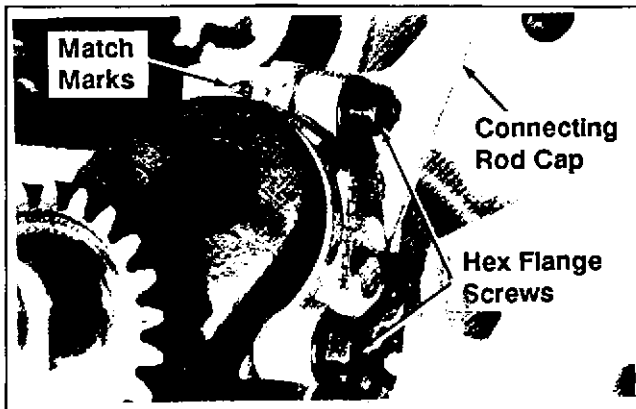

Figure 11-6. Installing Connecting Rod Fasteners.

5. Install the hex. flange screws and torque in several increments to **9 N•m (80 in. lb.)**.
6. Rotate the crankshaft until the piston is at top dead center in the cylinder bore.

INSTALL OIL SENTRY (Optional)

1. Install Oil Sentry™ float switch in crankcase. Refer to Section 8 and Figure 11-7. Torque the float switch to **13.6 N•m (120 in. lb.)**.

NOTE: The Oil Sentry™ float switch must be installed so the float arm is free to pivot toward the center of the crankcase.

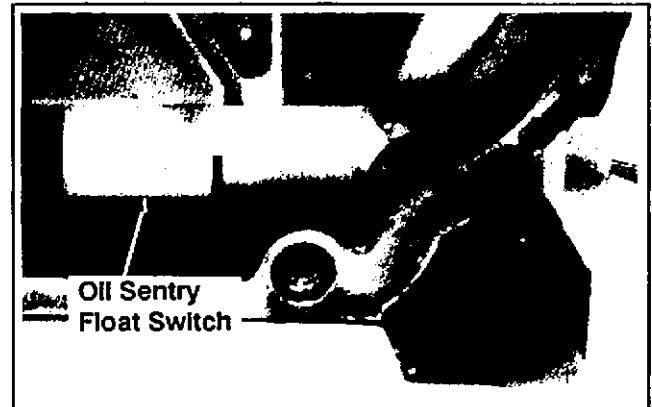

Figure 11-7. Installing Oil Sentry™ Switch.

2. Install the Oil Sentry™ float switch baffle and hex flange screw.

INSTALL GOVERNOR GEAR AND CROSS SHAFT

1. Install plain washer and governor gear on crankcase stud. See Figure 11-8.

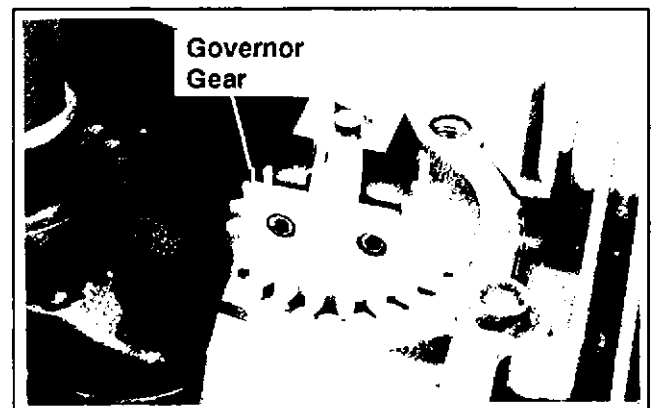

Figure 11-8. Installing Governor Gear.

2. Install small plain washer on cross shaft and install cross shaft (from inside closure plate) through bore in closure plate. See Figure 11-9.

SECTION 11 REASSEMBLY

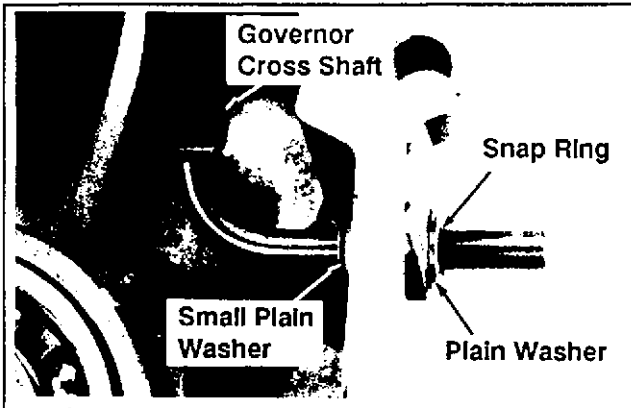

Figure 11-9. Installing Governor Cross Shaft.

3. Install plain washer and hitch pin.

INSTALL TAPPETS AND CAMSHAFT

1. Lubricate the tappets and tappet bores in crankcase with engine oil.
2. Install the tappets into the appropriate intake or exhaust tappet bore in the crankcase. See Figure 11-10.

NOTE: The intake tappet is the one farthest from the crankcase gasket surface. The exhaust tappet is nearest to the crankcase gasket surface.

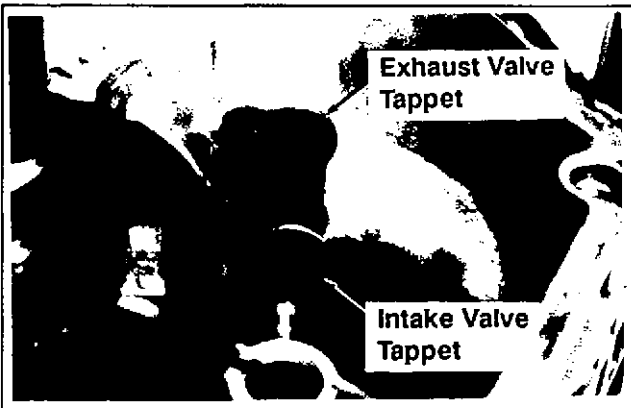

Figure 11-10. Installing Tappets.

3. Lubricate the camshaft bearing surfaced with engine oil.
4. Align the timing marks on the camshaft gear and crankshaft gear. Lower the camshaft into the bearing surface in crankcase.

Make sure the camshaft, crankshaft, and governor gears mesh and the timing marks on camshaft and crankshaft are aligned. See Figure 11-11.

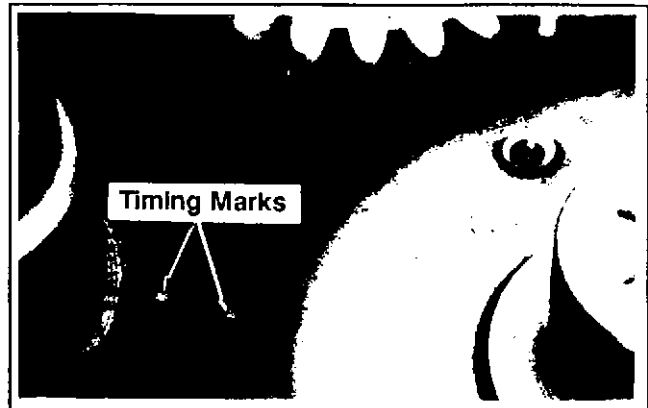

Figure 11-11. Aligning Crankshaft Gear And Cam Gear Timing Marks.

INSTALL CLOSURE PLATE

1. Make sure that the sealing surfaces of the closure plate and crankcase have been cleaned as described in Section 10.
2. RTV silicone sealant is used as a gasket between the closure plate and crankcase. GE Silmate™ type RTV-1473 or RTV-108 silicone sealant (or equivalent) is recommended.

NOTE: Always use fresh sealant. Using outdated sealant can result in leakage. Refer to Section 2 – “Special Tools” for information on the 52 597 02 silicone sealant dispenser tube.

3. Apply a 1/16” bead of sealant to the closure plate as shown in Figure 11-12.

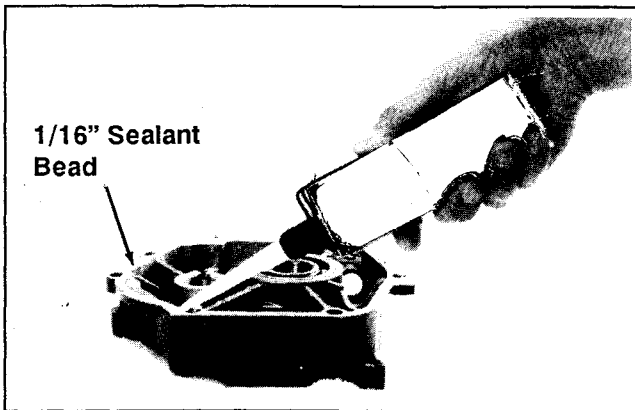

Figure 11-12. Applying Sealant To Closure Plate.

NOTE: Turn governor cross shaft clockwise before installing the closure plate. Cross shaft must rest on governor for proper operation.

4. Install the closure plate to the crankcase and install the six hex. flange screws. Tighten the screws hand tight.
5. Torque the fasteners, in several increments in the sequence shown in Figure 11-13, to **22.6 N•m (200 in. lb.)**.

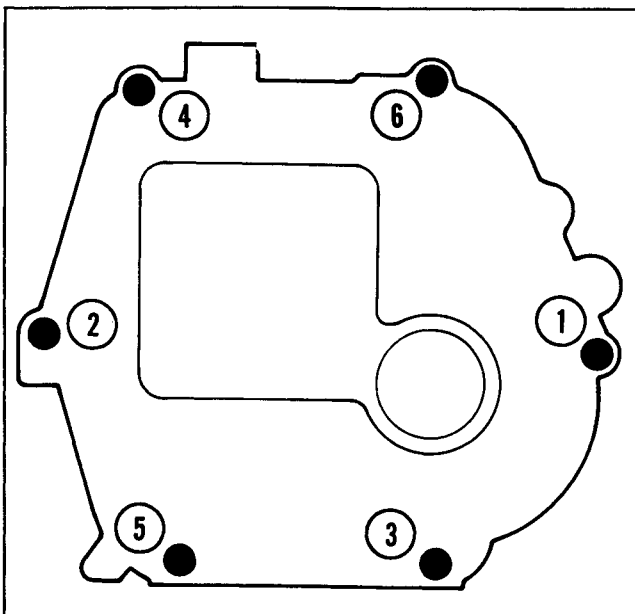

Figure 11-13. Closure Plate Fastener Torque Pattern.

INSTALL OIL SEALS

1. Slide the **seal protector sleeve NU-12021**, over the crankshaft. Generously lubricate the lips of the oil seal with light grease. Slide the oil seal over the sleeve.

Assemble **handle KO-1036** and **seal driver KO-1034**. Install the crankcase seal until the driver bottoms against the crankcase. Assemble **handle KO-1036** and **seal driver KO-1043**. Install the closure plate seal until the driver bottoms against the closure plate. See Figure 11-14.

NOTE: Oil seal on PTO side of crankshaft should be installed to a depth of **5 – 7 mm (0.20 – 0.28 in.)** below lip of crankshaft bore.

NOTE: Engines equipped with optional camshaft PTO use **handle KO-1036** and **seal driver KO-1035** to install oil seal in camshaft bore.

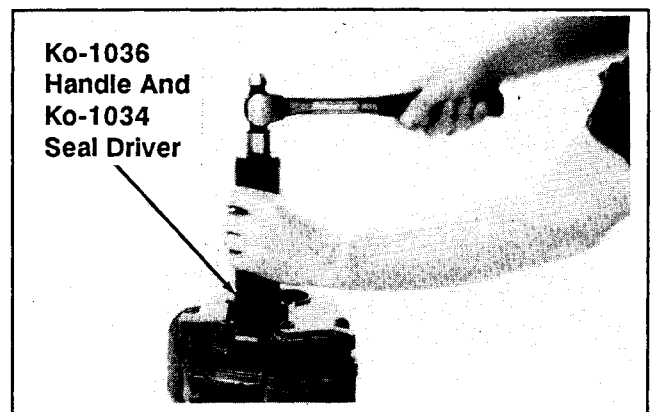

Figure 11-14. Installing Oil Seals.

INSTALL FLYWHEEL

⚠ WARNING: Damaging Crankshaft And Flywheel Can Cause Personal Injury! *Using improper procedures to install the flywheel can crack or damage the crankshaft and/or flywheel. This not only causes extensive engine damage, but can also cause personal injury, since broken fragments could be thrown from the engine. Always observe and use the following precautions and procedures when installing the flywheel.*

SECTION 11 REASSEMBLY

NOTE: Before installing the flywheel, make sure the crankshaft taper and flywheel hub are clean, dry and completely free of lubricants. The presence of lubricants can cause the flywheel to be over-stressed and damaged when the flange screw is torqued to specification.

NOTE: Make sure the flywheel key is installed properly in the keyway. The flywheel can become cracked or damaged if the key is not installed properly in the keyway.

NOTE: Always use a flywheel strap wrench to hold the flywheel when tightening the flywheel fastener. Do not use any type of bar wedge between the cooling fins or flywheel ring gear, as these parts could become cracked or damaged.

1. Install the woodruff key into the keyway in the crankshaft.
2. Place the flywheel over the keyway/crankshaft. Install the drive cup, plain washer (flat side of washer towards the drive cup), and the hex. flange screw. See Figure 11-15.

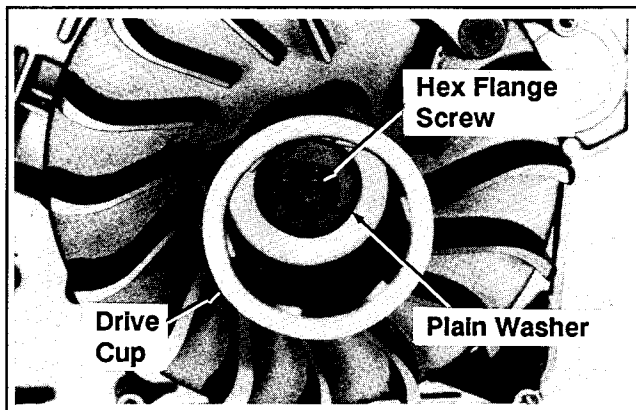

Figure 11-15. Installing The Flywheel.

3. Hold the flywheel with a strap wrench and torque the hex flange screw to **67.8 N•m (50 ft. lb.)**. See Figure 11-16.

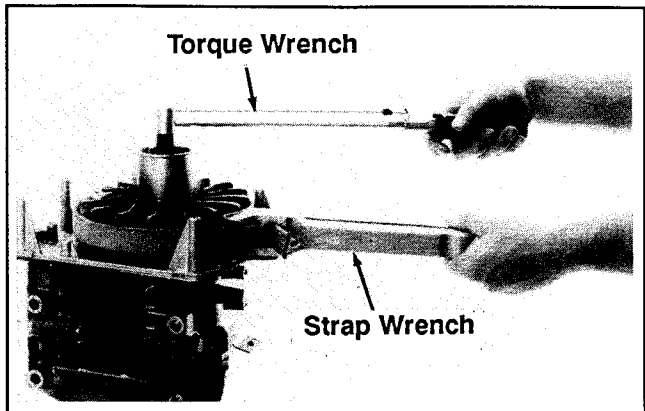

Figure 11-16. Tightening Flywheel Fastener.

INSTALL IGNITION MODULE

1. Turn flywheel until magnet is opposite the position where the ignition module will be installed.
2. Install ignition module loosely to bosses on crankcase with two hex. flange screws. Move module as far away from flywheel as possible then tighten screws just enough to hold.
3. Rotate the flywheel in clockwise direction until the magnet is inside the first and center laminated legs of the ignition module. The third leg will be outside.
4. Insert a **0.250 mm (0.010 in.)** flat feeler gauge or shim stock between the **center** and **leading** leg then loosen the screws allowing the magnet to draw the module against the gauge. Push against module with thumb to hold legs tight against the gauge while tightening screws to torque specified in Step 5. This establishes the correct air gap between the two legs—don't try to gap the trailing leg as it will be different.

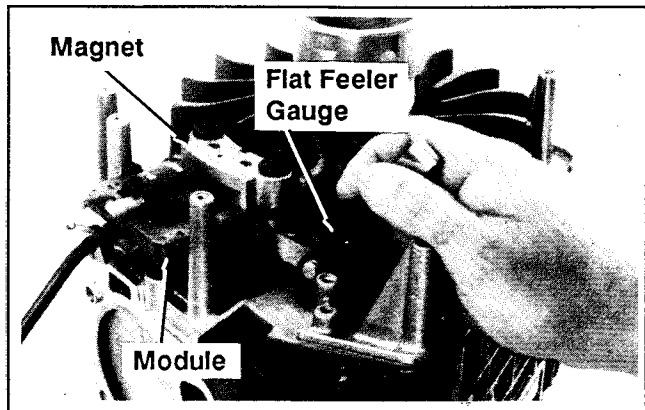

Figure 11-17. Installing Ignition Module.

5. Tighten the hex. flange screws as follows:

First Time Installation On A New Short Block:
6.2 N•m (55 in. lb.).

All Reinstallations: **4.0 N•m (35 in. lb.).**

6. Rotate the flywheel back and forth; check to make sure the magnet does not strike the module. Check the gap between the center and leading legs only with a feeler gauge and readjust if necessary.

REASSEMBLE CYLINDER HEAD COMPONENTS

1. Lubricate with engine oil, and install the valves, valve springs, and valve spring caps. See Figure 11-18.

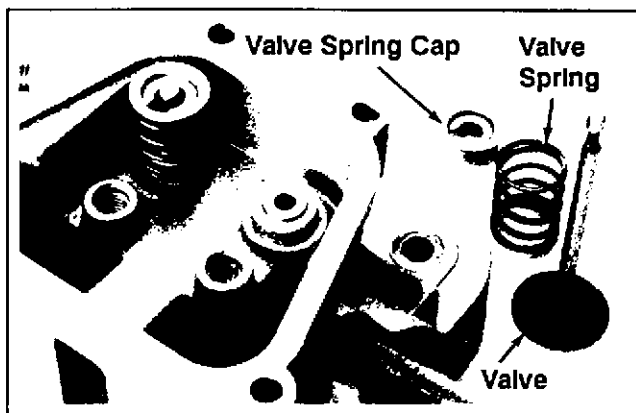

Figure 11-18. Installing Valves.

2. Compress the valve spring by pushing down on the valve spring cap. Lock the valve spring cap in place on the valve stem.

NOTE: Support valves from beneath the cylinder head to make installing the valve spring caps easier.

3. Install the push rod guide plate, rocker arm studs, rocker arms and balls, and rocker arm adjusting nuts. See Figure 11-19. Lubricate with engine oil.

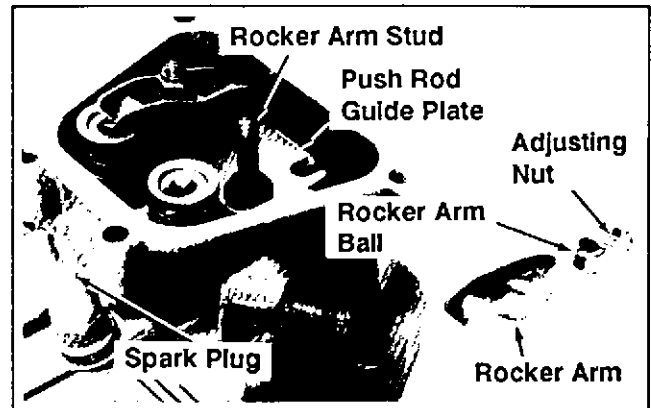

Figure 11-19. Installing Rocker Arms And Spark Plug.

INSTALL CYLINDER HEAD

1. Install a new cylinder head gasket.
2. Install the cylinder head and tighten the hex. flange screws in several increment in the sequence shown in Figure 11-20 to **22.6 N•m (200 in. lb.)**.

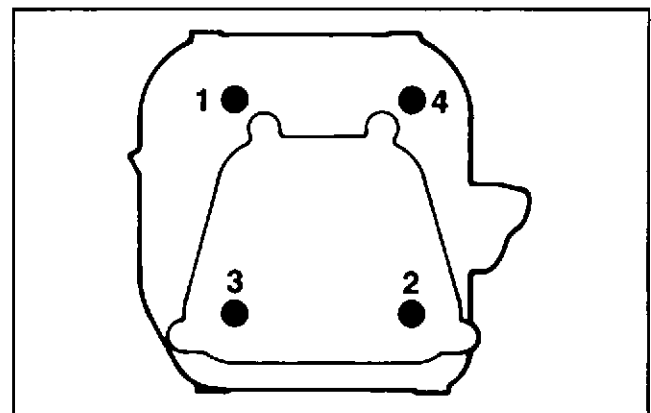

Figure 11-20. Cylinder Head Fastener Tightening Sequence.

3. Set spark plug gap at **1.02 mm (0.040 in.)**. Install spark plug in cylinder head and torque to **24.4/29.8 N•m (18/22 ft. lb.)**.
4. Install the push rods. Check that the push rods are seated on the tappets and rocker arms.
5. Adjust valve to tappet clearance as follows:
 - a. Position the crankshaft so the piston is at the top of the compression stroke (the camshaft is not pushing the tappets and push rods).

SECTION 11 REASSEMBLY

- b. Insert a flat feeler gauge between the rocker arm and valve stem. See Figure 11-21.

The recommended valve to rocker arm clearance for both intake and exhaust is **0.038/0.051 mm (0.0015/0.0020 in.)**.

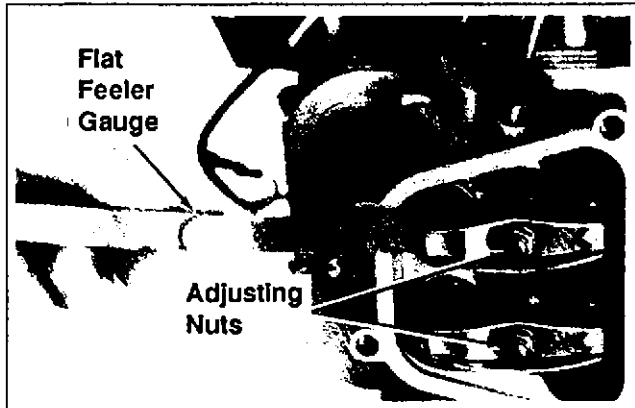

Figure 11-21. Adjusting Rocker Arm/Valve Clearance.

- c. Adjust clearance by turning the adjusting nut: clockwise to decrease valve to rocker arm clearance, counterclockwise to increase valve to rocker arm clearance.
6. Install a new valve cover gasket. Install the breather assembly on the cylinder head. See Figure 11-22.

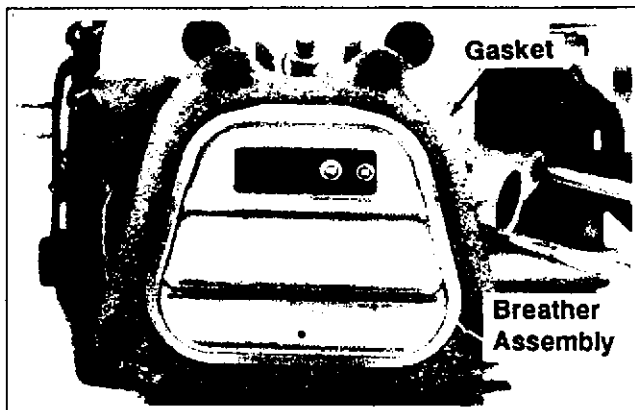

Figure 11-22. Installing Breather Assembly.

7. Install the valve cover. Torque the hex flange screws to **3.4 N·m (30 In. lb.)** using the sequence shown in Figure 11-23.

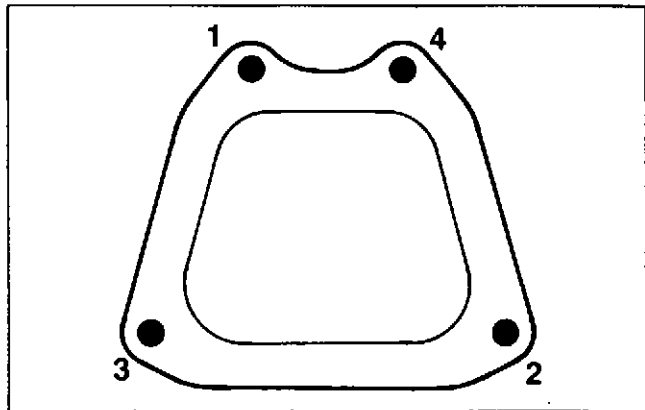

Figure 11-23. Valve Cover Fastener Tightening Sequence.

INSTALL KILL SWITCH, THROTTLE, AND GOVERNOR LINKAGE

1. Install kill switch lever, bushing, and throttle lever on the crankcase using hex. flange screw. See Figure 11-24.

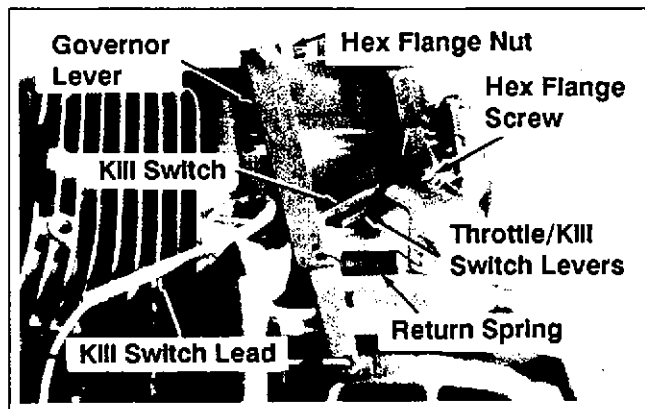

Figure 11-24. Installing Kill Switch, Throttle And Governor Linkage. (CH5 Shown)

2. Connect the kill switch lead to the kill switch.
3. Install the return spring in the first hole of the throttle lever (the hole nearest the end of the throttle lever).
4. Install the governor lever on the governor cross shaft. Install the return spring in the third (middle) hole of the governor lever.

INSTALL BAFFLES AND BLOWER HOUSING

NOTE: Leave all hardware slightly loose until all sheet metal parts are in position.

1. See Figures 11-25 and 11-26. Install the blower housing using Phillips head screws in the locations shown in Figure 11-25.

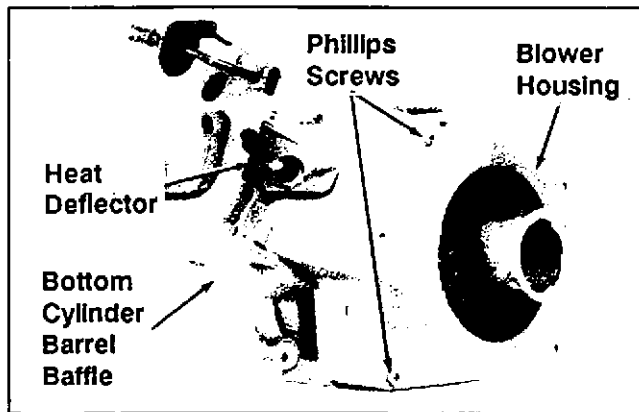

Figure 11-25. Installing Blower Housing And Baffle.

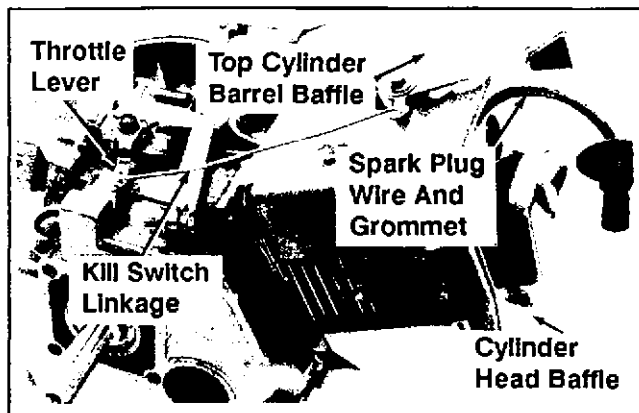

Figure 11-26. Installing Baffles. (CH5 Shown)

2. Install the gasket and heat deflector on the intake studs.
3. Install the bottom cylinder baffle using hex. flange screws.

4. Connect the kill switch linkage in the first hole of the throttle lever. Install the top cylinder barrel baffle using hex. flange screws.
5. Install the cylinder head baffle onto the top and bottom cylinder baffles.
6. Tighten all hardware.

INSTALL MUFFLER

1. Install new gasket and muffler on exhaust outlet flange. See Figure 11-27 for CH5.

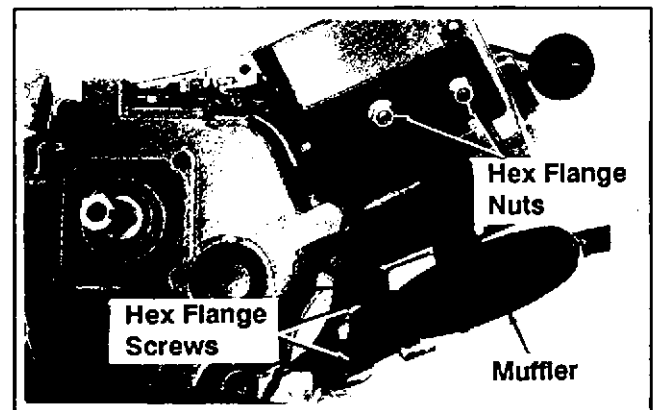

Figure 11-27. Installing Muffler On CH5.

2. Install hex. flange nuts onto exhaust studs and hex. flange screws in muffler bracket. Torque hex. flange nuts to 22.6 N·m (200 in. lb.).

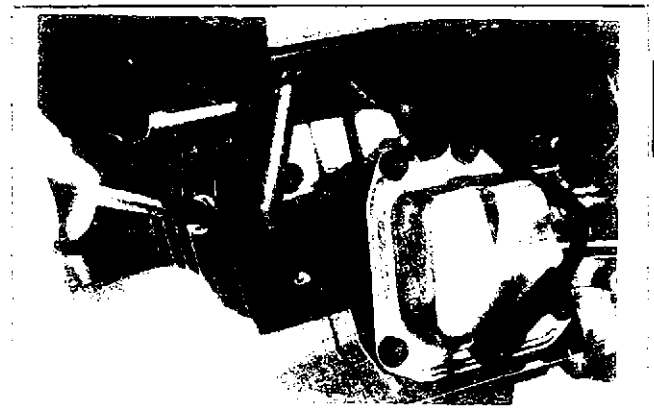

Figure 11-28. Installing Muffler On CH6.

SECTION 11 REASSEMBLY

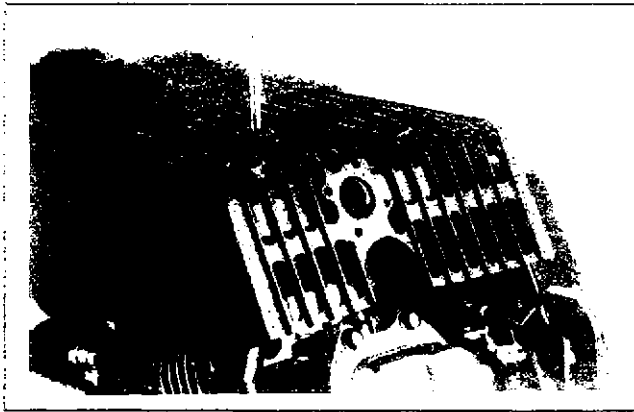

Figure 11-29. Installing Heat Shield On CH6.

INSTALL CARBURETOR AND LINKAGE

1. Install new gasket and carburetor onto intake manifold studs. See Figure 11-30.

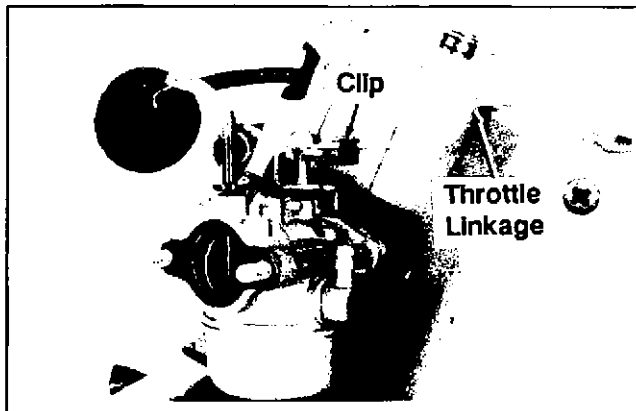

Figure 11-30. Installing Carburetor.

2. Install the throttle linkage to the carburetor throttle lever using the linkage clip.

INSTALL CONTROL PANEL (CH6)

1. Reinstall the control panel on CH6 if so equipped and if removed earlier.

INSTALL FUEL TANK AND LINE

⚠ WARNING: Gasoline may be present in the carburetor and fuel system. Gasoline is extremely flammable, and its vapors can explode if ignited. Keep sparks, open flames, and other sources of ignition away from the engine.

1. Install the fuel tank and fuel line.

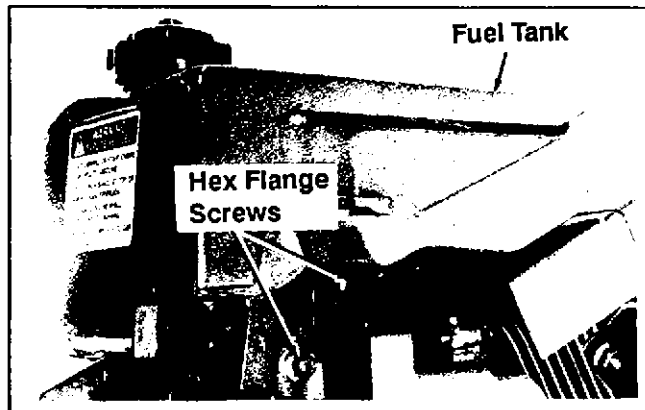

Figure 11-31. Installing Fuel Tank (CH5).*
(Earlier Version Shown)

2. On CH5, secure the fuel tank to the engine using hex. flange screws. Torque the hex. flange screws to 17 N•m (150 in. lb.). See Figure 11-31.

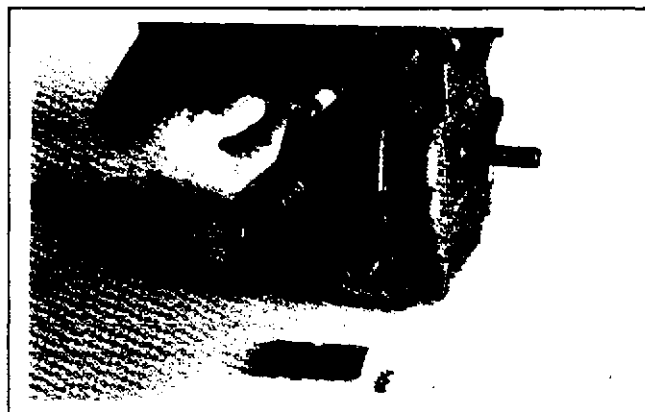

Figure 11-32. Installing Fuel Tank CH6.

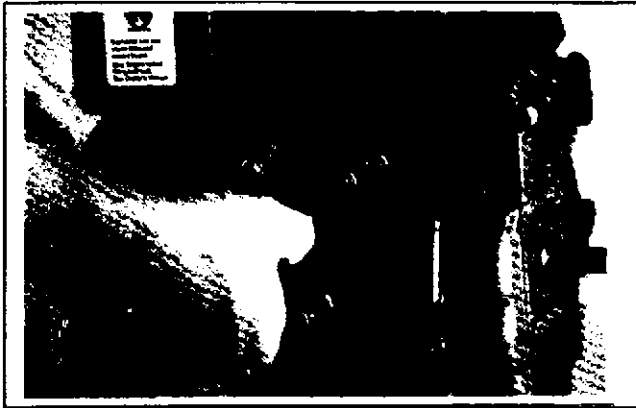

Figure 11-33. Tighten Tank Bracket Screws On CH6.

3. Install the fuel line on the carburetor inlet fitting. Secure the fuel line with a hose clamp. See Figure 11-34.

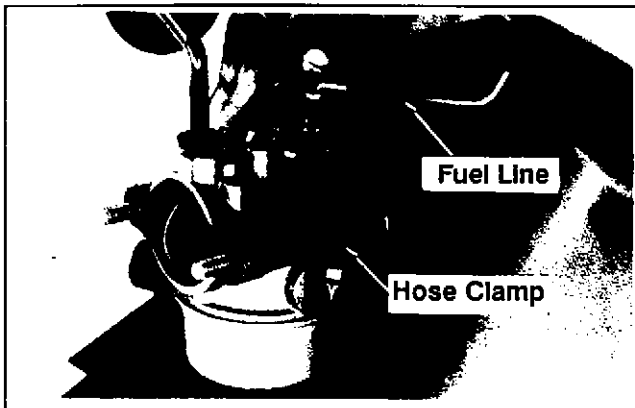

Figure 11-34. Connecting Fuel Line.

INSTALL FILL TUBE AND DIPSTICK (CH5)

NOTE: CH6 models do not have extended oil fill.

1. Make sure the two O-Rings on the oil fill tube and the O-Ring in the oil fill cap are in place.
2. Install oil fill tube into the hole in the crankcase on CH5. See Figure 11-35. Note: Some CH5 models have bracket at base of tube.

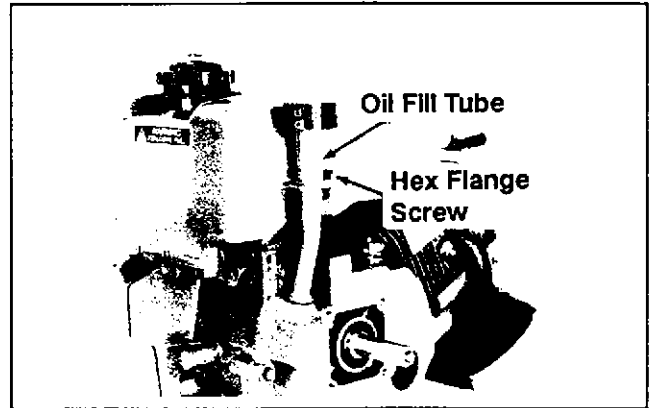

Figure 11-35. Installing Oil Fill Tube (CH5). (Some have bracket at base.)

3. Secure the oil fill tube to the fuel tank with the hex. flange screw and lock nut.

On CH6, reinstall the oil fill/check plug and drain plug.

INSTALL RETRACTABLE STARTER

1. Install the retractable starter and Phillips head screws to the blower housing. See Figure 11-36.

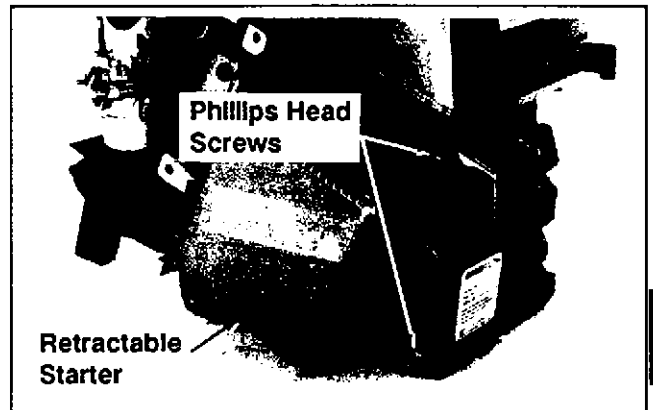

Figure 11-36. Installing Retractable Starter.

INSTALL AIR CLEANER (CH5 MODELS)

1. Install gasket, air cleaner base, and hex. flange nuts on intake studs. See Figure 11-37.

SECTION 11 REASSEMBLY

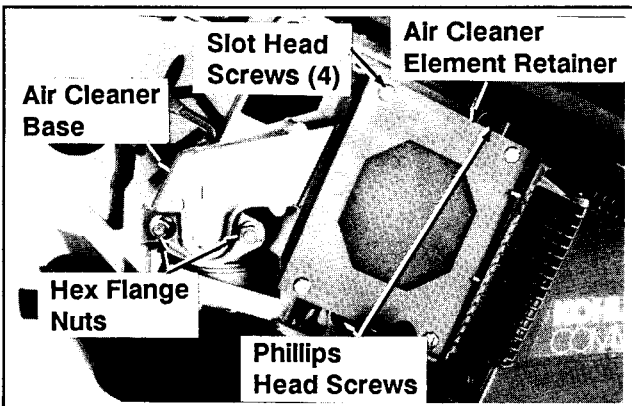

Figure 11-37. Installing Air Cleaner Base (CH5).

2. Install Phillips head screws to air cleaner.
3. Install the air cleaner element retainer. Be sure the retainer is hooked on tabs. Tighten the four slot head screws evenly. Install the precleaner.
4. Install the air cleaner cover as follows:
 - a. Slide the air cleaner cover onto the air cleaner base.
 - b. Be sure the tab at the bottom of the air cleaner cover snaps in place to lock the cover on the air cleaner base. Some CH5 models have retaining screw on cover--reinstall this screw if so equipped.

INSTALL AIR CLEANER (CH6 MODELS)

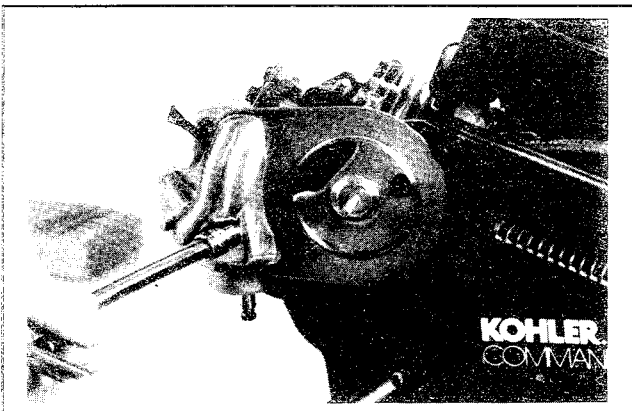

Figure 11-38. Installing Air Cleaner Base On CH6.

1. Install new carburetor gasket, then the air cleaner base to carburetor with the two nuts. Also install and secure the capscrew. See Figure 11-38.



Figure 11-39. Tighten Wing Nut.

2. Install filter element, precleaner and element cover. Secure with wing nut. Refer to Section 4B for correct sequence of components for CH6 air cleaner.
3. Install the air cleaner cover and turn the retaining knob to the right until tight.

PREPARE THE ENGINE FOR OPERATION

The engine is now completely reassembled. Before starting or operating the engine, be sure to do the following:

1. Make sure all hardware is tightened securely.
2. Make sure the oil drain plug and oil sentry pressure switch are tightened securely.
3. Fill the crankcase with the correct amount, weight, and type of oil. Refer to the oil recommendations and procedures in the "Safety and General Information" and "Lubrication System" Sections.
4. Adjust the governor. Refer to the "Fuel System and Governor" Section.
5. Adjust the carburetor idle fuel needle or idle speed adjusting screw as necessary. Refer to the "Fuel System and Governor" Section.
6. Make sure the maximum engine speed does not exceed **3750 RPM** (or as specified for the application). Adjust the throttle and choke controls and the high speed stop as necessary. Refer to the "Fuel System and Governor" Section.

FOR SALES AND SERVICE INFORMATION
IN U.S. AND CANADA, CALL
1-800-544-2444

KOHLER[®]engines

KOHLER CO KOHLER, WISCONSIN 53044

FORM NO.:	TP-2337-A
ISSUED:	7/89
REVISED:	2/93
MAILED:	3/93

LITHO IN U.S.A.