

**SCHULTE**<sup>®</sup>  
INDUSTRIAL GRADE

**XH1500**  
SERIES

# XH-1500/XH-1000 Rotary Cutters

*Where Innovation Comes First!*



**Increase Your Productivity**

**WORLD CLASS...BUILT TO LAST**

# XH1500/XH1000 Series 5

## FEATURES AT A GLANCE

The Schulte XH1500/XH1000 Series 5 Rotary Cutters are the latest version of Schulte's popular heavy duty rotary cutter line. They retain all of the best features of the original XH1500/XH1000 Rotary Cutters, such as tandem walking axles, heavy duty drive line and deck protection rings, while adding many new improvements.

Increased ground clearance, larger cutting chamber and increased blade tip speeds

Extra heavy duty 275hp dividerbox



Extra heavy duty Cat 6 (G8) cutter deck drive lines with large hi-torque, self-adjusting slip clutches

Internal gearbox mount reinforcement

Oil level sight glass

Extra heavy duty, 240hp right angle gearboxes with 3" (75mm) down shaft

Continuously welded, single domed, sweep-clean deck

Wing lift tower for easier operation & increased strength

Optional gauge wheel kit can be mounted on the left or right wing to aid in clearing road approaches during ditch mowing

Rugged hinge line

Adjustable and replaceable side skirt with skid shoes that are cast and cupped to reduce scrubbing on tight turns.

Cutting chamber depth of 15 3/8" (2" greater than the Series 4) improves cutting speed and quality

Walking or through axles available on both centre section and wings

Extra large 10.5 X 27 skid steer tires optional 26" laminated tires or 29" foam filled tires

All grease points on the main mower body have been eliminated, spring steel greaseable bushings are used only in the walking axles. All other major pivot points now use maintenance free, fibre wound bushings with 1 1/4" diameter pins for strength.

10' XH1000 Series 5



The totally redesigned, Series 5 XH1500 and XH1000 Rotary Cutters offer unparalleled cutting performance for demanding commercial and agricultural use. New gearboxes, increased blade tip speeds and greater space under the redesigned deck contribute to clean, quality cutting in all conditions. Depending on terrain and conditions, potential working speeds of up to 30-50% faster than our already speedy Series 4 can be achieved.

**WORLD CLASS...BUILT TO LAST**

## Heavy Duty Drive System

Drive system consists of a traditional four gearbox arrangement with a 275 hp splitter and 240 hp down boxes, both with 1 3/4 X 20 input spline shafts. The 75 mm down shafts are splined and tapered to securely hold the pan for years of trouble-free service. The drive line includes Bondioli and Pavesi G8 (Cat 6) drive lines on the cutter, SFT H8 (Cat 6) 540 RPM CV and a SFT S6 (Cat 5) 1000 RPM CV



**275hp Splitter Box** with forward mounted self adjusting clutches for easy servicing



**New 240hp\* Right Angle Gearboxes**  
Extra heavy duty 1 3/4" input shafts.  
3" (75mm) tapered & splined down shafts.



**Gearbox Sight Glass**  
Lets you easily check oil levels with a glance



**Reinforced Centre Gearbox Mount**

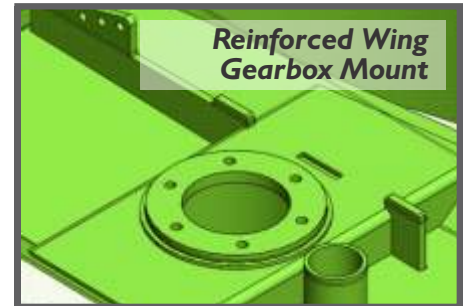

**Reinforced Wing Gearbox Mount**



**Self Adjusting, Forward Mounted Slip Clutches**  
Allows easy access for adjustments



**Gearbox Mounts**  
Heavy duty gearbox mounting pads are able to handle the roughest working conditions. Gearbox bolts can be retightened from just the top side.

**Stump Jumpers** 1/4" thick spun & pressed formed (dynamically balanced) Stump Jumpers with Pentagon Blade Bolt design allows cutter sections to ride over obstructions. Flat 1" thick blade bar design with heavy duty 3/8" cross bracing on centre pan helps prevent premature wear and cracking.



**Blades/Options** Various blade options are available from Schulte such as 4" or 5" wide Schulte Super Suction, standard suction, brush blades and shredder blades. Whatever your application, Schulte has your blade.



**Pentagon Blade Bolt Bushing** Our stump jumpers feature a Pentagon Blade Bolt design with C1045 replaceable bushings welded into the crossbar, ensuring years of trouble free use!  
A Schulte exclusive!

**Shielding** Comprehensive drive line shielding allows the use of short bells on power shafts resulting in better access to grease zerks. The shielding can be easily unclipped for access to gearboxes, slip clutches and universal joints. A self-locking latch and support straps apply force under the main shield to prevent it from rattling.



**Deck Rings.** (Industry First) 3/8" thick formed deck rings are welded to the under side of the decks. These rings prevent the blades from damaging the deck should a blade become bent. Deck rings have been standard on the Schulte XH models since 1992.





**Floating Hitch**

The XH-1500 Series 5 incorporates a floating hitch through the use of tension links. These links are connected from the hitch to the rear beam and are allowed to free float in one direction. This system allows the front of the cutter to easily pass over obstacles without causing damages to the tension links or putting unnecessary stress on the deck.

The Series 5 hitch is also equipped with a bolt in, replaceable 2 1/4" swivel which allows for maximum ground contouring without putting unnecessary twisting on the tractor draw bar.

**Deck and Cutting Chamber**

The deck of the Series 5 is single domed and continuously welded on the top. The perimeter of the deck is made from HSS square tubing to maximize strength and rigidity. The decks cutting chamber depth is 2" greater than the Series 4, coming in at 15 3/8" deep. This increased depth combined with new gearboxes and faster blade tip speeds allow for an increase in production speed of a whopping 30-50% (depending on terrain and conditions). This has the potential to increase the amount of work taken on, reduce the amount of time worked and reduce operational hours on your tractor.

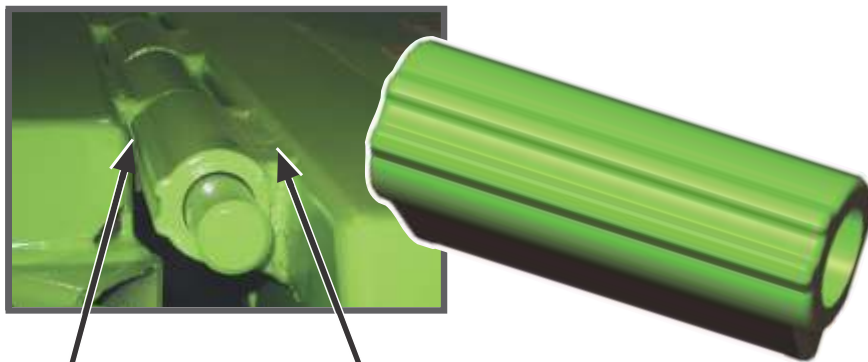
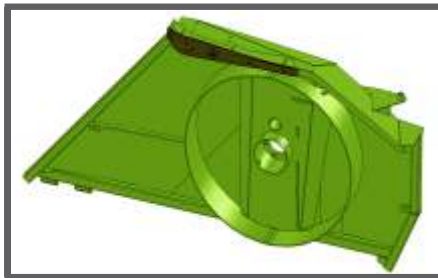

*Wiper Seal*

*Flat surface weld area*

**Tough Hingeline** Cast hinge with a wiper seal prevents blow through of grass and material to the top side of the deck, and improves square and flat welding area to frame.

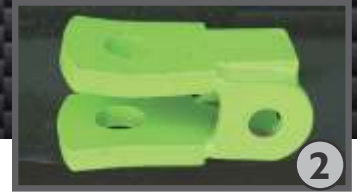

**Hitch Options**

- ① Precision Hitch
- ② Standard clevis
- ③ Pro Level Hitch

The cutter can be equipped with a Schulte Precision Hitch, a standard clevis hitch or our Pro Level Hitch.



**Wing Lift Tower**

Designed for easier operation and increased strength, the double acting independent wing lift cylinder was designed to put less stress on wings and hinges.



**Suspension Incorporates Rubber Isolators** that offer low maintenance with no moving parts. The three bolts are only snugged up allowing the rubber to flex, allowing the rear beam to move smoothly up and down. This produces a more even cut over rough surfaces.



**Rear Beam** The centre section wheel standard uses a large 6" O.D. x 5.5" I.D tube. The lifting system is symmetrical, resulting in even loading on both sides of the centre frame. Spring steel greaseable bushings and high carbon steel pins are used in the walking axles.



**Wing Suspension** with rubber isolators. Lock head pins, with maintenance-free pivot points, ensure proper lift height for the life of your Schulte cutter.

### Walking Axle and Tire Options

The cutter can be equipped with walking axles or standard axles across the entire machine.

Tire options available are 26" diameter laminated tires, 29" foam or air filled aircraft tires or large 10.5 X 27 skid steer tires for increased floatation and better holding power in the ditch.

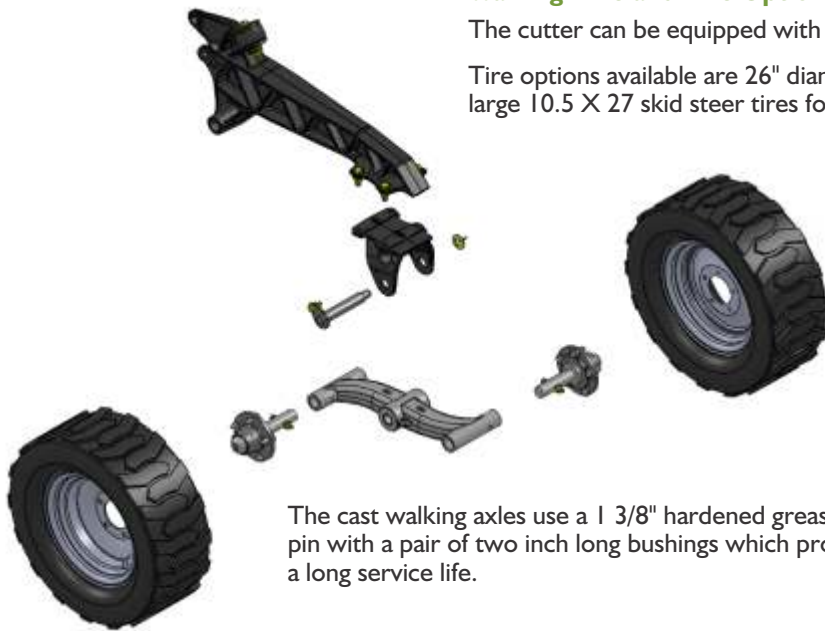

The cast walking axles use a 1 3/8" hardened greaseable pin with a pair of two inch long bushings which provide a long service life.



Skid Steer



Laminated



Foam or Air Filled

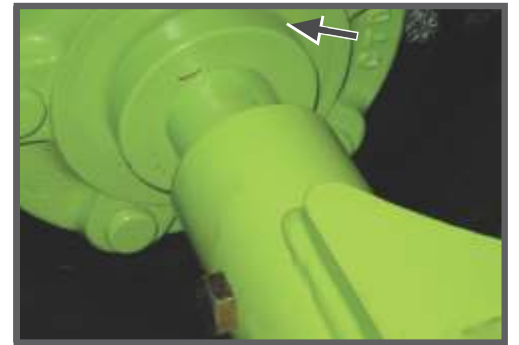

### Metal Axles Seal Guards

The Series 5 uses bolt-in, five bolt 517 hubs and spindles with a rear steel guard for extra protection.



### Phased Hydraulic Cylinders

These are standard to provide level lifting across the width of the cutter. Centre and wing sections all raise and lower together. Cutting height is controlled by the centre depth stop for one touch leveling.



### Leveling

Outer wing wheels include an adjustment screw that can be placed out of level up or down 3". This allows the cut height to be fine tuned across the machine for precision cutting along roadsides.



**Optional Gauge Wheels** lift the wings over obstacles such as approaches preventing damage to the wings.

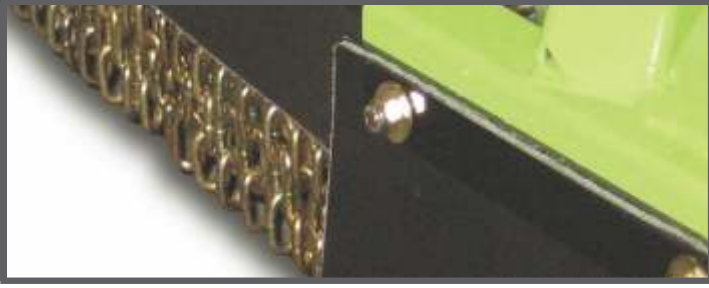

**Double Safety Chains** with individually replaceable links and **Half Length Front Rubber Belting** which helps reduce thrown material and objects, are both standard equipment.



**Wing Skids** Replaceable outer wing skids are two piece, allowing for easy height adjustment. The forward section is cast and cupped to prevent gouging and scrubbing on sharp turns.

**Centre Skids** Cast and cupped skid shoes are designed to reduce scrubbing on sharp turns.



**Hose Management System**

Keeps hoses up and out of the way while allowing for easy turning and worry-free operation.



**Hose Locations**

Hoses are organized along the right of the centre frame so that shielding covers can be more easily tilted back for service access.



**Narrow Transport Width**

The NTM (Narrow Transport Mechanism) is incorporated into the centre hydraulic lock up system. The wing wheels can be tucked inside of the width of the wings when in transport mode allowing for a stable, safe and ultra narrow transport width of 89".



**Eliminator Brush and Weed Suppressor**  
Cut and spray in one pass with the chemical application spray kit for the XH1500 rotary cutter. Spray drift is reduced because the product application occurs under the mower deck via the spinning blades.



# Testimonials



## **XH-1500 Industrial Grade Mower**

**ROMAN ALBERT** - (Lot Maintenance Inc. Tulsa OK)

*"We were getting paid by the acre so we were always worried about production and cost per acre. We were having problems with competitive cutters. We tried the Schulte cutters and it didn't take us long to figure out that it was the cutter we wanted. We didn't realize how bad our previous cutters were until we put a Schulte on the ground."*

*"We think the Schulte cuts better period. It's unbelievable the quality of cut that we can get at what we would call a high rate of mowing speed. We get paid by the acre so productivity is a big deal for us, ground speed is a big deal for us. We've figured out when we look at the big picture, we go ahead and spend the money on the big tractors, and on the good cutters, by the end of the year we have recouped that investment several times over."*

---



## **XH-1500 Industrial Grade Mower**

**ERIC NELSON** - Econ Services (Saskatoon, SK)

*"The XH1500 Series 5 is heavy duty, the increased space between the deck and ground allows the driver to go faster and it easily cuts through thick grass. The larger skid steer tires make the mower more stable in soft areas. The corner gauge wheel limits damage to approaches as it rolls up and picks up that side of the mower. The Series 5 mower is top of the line for my needs".*

---



## **XH-1500 Industrial Grade Mower**

**Darryl Hammond** - Hammond Land Development (Victoria, TX)

*"We mow highway right of ways and pipeline right of ways, last year we ran 20 tractors, all with Schulte cutters. I've been running Schulte for about six years, probably logged over 50,000 hours on Schulte mowers. In my opinion they're the best you can buy anywhere, we've had extremely good luck with them. The oldest cutter I have is I think is nearly seven years old, it cuts as good as the four I bought last year".*

*"We generally start mowing the end of March, we'll ramp our mowing services up, the highway crews will start mowing in May, by the time we get there we'll have all of our machines deployed. They usually stay out until the second week of January if we have good weather".*

*"They're the best I've ever run, and I've tried a bunch of different varieties".*

# Specifications

## DESCRIPTION

Cutting width  
Overall width  
Overall length  
Overall length with walking axles  
Transport width, min  
Transport height  
Deck thickness  
Side band skirt depth  
Side band skirt thickness  
Weight range, approx.  
Transport hitch weight, approx.  
Minimum tractor HP  
Recommended tractor HP  
Cutting height  
Ground clearance, transport  
Cutting capacity  
Blade overlap  
Divider gearbox rating  
Centre/wing gearbox rating  
Blade tip speed,  
Centre  
Wing  
Blade tip speed,  
Centre  
Wing  
Wing working range  
Wing float range  
Drive Size centre and wings  
540 CV  
1000 CV

## XH-1500 Series 5

180" (4.57m)  
189" (4.80m)  
198" (5.03m)  
207" (5.26m)  
89" (2.26m)  
84" (2.13m)  
7GA (3/16") (4.6mm)  
15 3/8" (.39m)  
1/4" (6.35mm)  
6950lbs (3152kg)  
2500lbs (1134kg)  
70 HP (52kW)  
90 HP (67kW)  
1.5 to 19.25" (38 to 490mm)  
18.5" (470mm) (27" tires)  
5" material (127mm) with brush blade  
6.5" (165mm)  
275 HP (205kW)  
240 HP (179kW)\*  
540 rpm  
848 rpm, 16,286 ft/min (4964m/min)  
986 rpm, 16,030 ft/min (4886m/min)  
1000 rpm  
850 rpm, 16,390 ft/min (4996m/min)  
1002 rpm, 16,290 ft/min (4965m/min)  
25° down to 90° up  
25° down to 45° up  
Cat 6  
Cat 6  
Cat 5

## XH-1000 Series 5

126" (3.20m)  
139" (3.53m)  
198" (5.03m)  
207" (5.26m)  
89" (2.26m)  
84" (2.13m)  
7GA (3/16") (4.6mm)  
15 3/8" (.39m)  
1/4" (6.35mm)  
6100lbs (2767kg)  
2100lbs (953kg)  
70 HP (52kW)  
90 HP (67kW)  
1.5 to 19.25" (38 to 490mm)  
18.5" (470mm) (27" tires)  
5" material (127mm) with brush blade  
6.5" (165mm)  
275 HP (205kW)  
240 HP (179kW)\*  
540 rpm  
848 rpm, 16,286 ft/min (4964m/min)  
986 rpm, 16,030 ft/min (4886m/min)  
1000 rpm  
850 rpm, 16,390 ft/min (4996m/min)  
1002 rpm, 16,290 ft/min (4965m/min)  
25° down to 90° up  
25° down to 45° up  
Cat 6  
Cat 6  
Cat 5

## FLX-1510 FLEX ARM

Heavy duty 11L x 15, 12 ply tires with a load capacity of 4000 lbs. ~Cut directly in-line with the tractor or at any offset distance up to 122" (10.16ft) ~Large 2-1/2" castor pivot shaft ~6000 lb capacity 6 bolt hubs ~Spring steel tension bushings and induction hardened pins at major pivot points ~Minimum of three (3) hydraulic circuits required to operate the FLEX ARM with a 15' or 10' mower ~If independent wing lift is required on a 15' mower then four (4) hydraulic circuits or the optional, selector valve kit is required, ~Heavy duty 3-1/2 X 36 welded hydraulic cylinder ~Weight of the FLX-1510 is 2557 lbs ~Safety lighting kit ~Bolt-in replaceable axles ~The arm can be easily detached from the rotary cutter by disconnecting the hitch and the stabilizer strut, ~Continuous power rating of 200HP at 1000 RPM ~Accommodates 540 or 1000 RPM power delivery from the tractor ~Optional six port selector valve kit for independent wing action or limited tractor hydraulic outlets,

### Transport widths:

**Arm and rotary cutter:** 70" to the left of the tractor and 52" to the right for a total of 121"

**Arm alone:** 70" to the left of the tractor and 47" to the right for a total of 117"

**Arm and rotary cutter with stop block installed on the transport lock bar:** 55" to the left of the tractor and 66" to the right. In this configuration the arm is 19" off centre the stop block can be installed when working on narrow roads to improve clearance for oncoming traffic.



**SCHULTE**

Schulte Industries Ltd.

P.O. Box 70, Englefeld, SK, Canada S0K 1N0  
Tel: (306) 287-3715 Fax: (306) 287-3355  
E-Mail: info@schulte.ca  
Visit our Web site at: www.schulte.ca



Sold By:

Schulte Industries Ltd. reserves the right to change the design, material and specifications of its products without notice. Illustrations may include optional equipment and accessories, and may not include all standard equipment. Part No.1000-147

PRINTED IN CANADA

212507

\* Based on intermittent use. Schulte is a registered trademark of Alamo Group Inc.

Schulte Industries Ltd. reserves the right to change the design, specification of it's products without notice. Illustrations may include optional equipment and accessories, and may not include all standard equipment