



**8000**

ROTARY TEDDERS

# WHEN FARMING MEANS BUSINESS

Realising the full potential of farming is about growing and developing your business, not only your crop or livestock, but also your profit. Improve productivity and profitability by focusing on the positives and minimising disadvantageous aspects, through strong, dedicated management.

Success springs from determination and clear targets, from laying down the appropriate strategy and allocating correct investments for the future. Quality results require the right ideas and equipment. When there is work to be done, you need the optimal setup and smart solutions that support you towards an easier, more profitable way of working. You need solutions that make tough and demanding conditions less complicated.





## PROCESS

Processing the crop efficiently will boost your grass management, ensuring the correct dry matter content and best possible nutritional value.

## COMPACTLINE MODELS

### *Mounted Rotary Tedders*



**Kverneland 8446-8452-8452 T**  
Compact tedders with low maintenance.  
Working width of 4.60-5.20m.



**Kverneland 8460-8480**  
Compact tedders with 6.05 and 8.05m working width  
- ideal for hay making.

# PROLINE MODELS

## *Mounted Rotary Tedders*



### **Kverneland 8555-8568-8576-8590-85112**

New Generation of heavy Duty mounted tedders - strong driveline - compact transport dimensions.  
Working width of 5.50, 6.80, 7.60, 9.00 and 11.2m.

## *Carrier Frame Tedders*



### **Kverneland 8590 C-85112 C**

Carrier frame tedders with 9.0 and 11.2m working width.



### **Kverneland 85140 C**

Carrier frame tedders with 13.00m working width.

Gearbox does not serve as part of the mainframe, but is bolted on. No strain is transmitted to the gearbox.

Double bearing on both sides of the drive shaft for highest durability to withstand the most severe conditions.

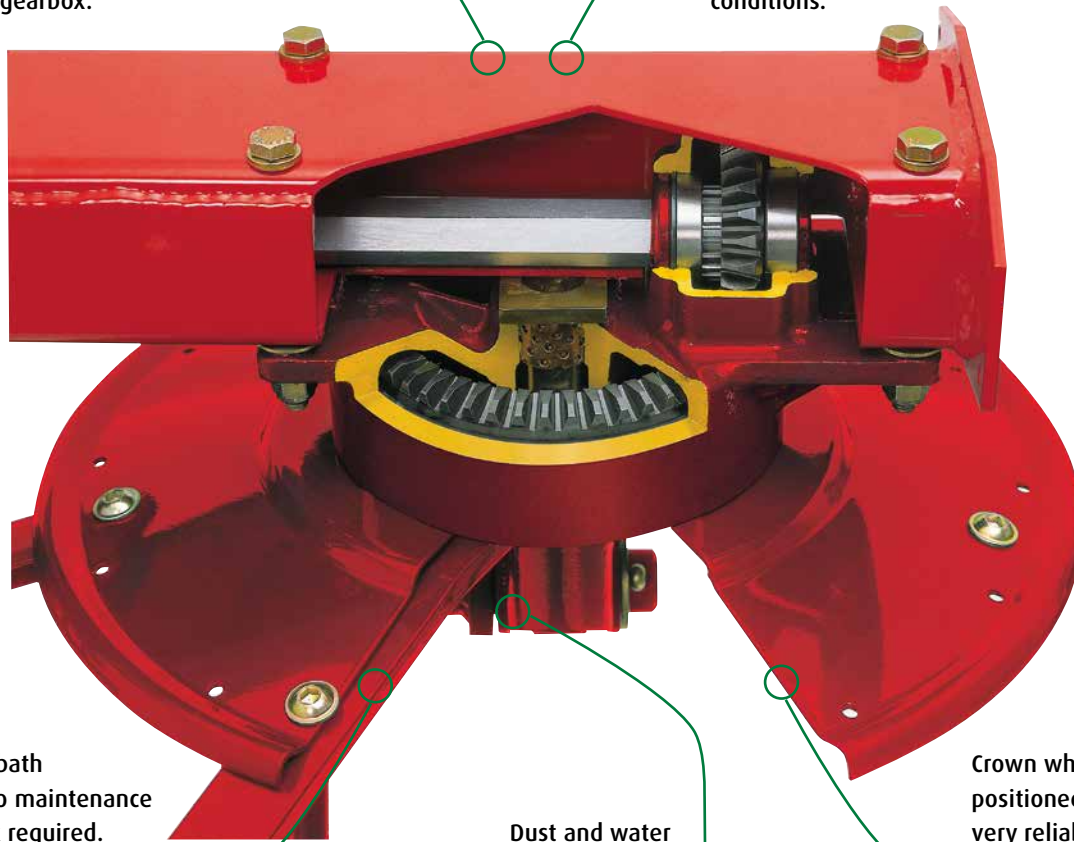

Permanent oilbath lubrication - no maintenance of the gearbox required.

Dust and water proof gearbox design. No corrosion.

Crown wheel and pinion positioned in one housing for very reliable drive.

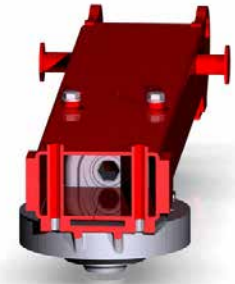

The large drive shafts and double U-joints give smooth, efficient transfer of power through the frame allowing each rotor to accurately follow field contours.



Maintenance-free roller bearing for best possible performance and higher second hand value.

## SOLID DESIGN

### - MAINTENANCE-FREE OPERATION

#### A Strong Reliable Heart

Kverneland ProLine tedders feature a **uniquely designed** self-contained rotor gearbox. The ProLine gearbox requires **no maintenance**, and is situated in an enclosed oilbath, set up to ensure permanent lubrication. No service or maintenance of the ProLine gearbox is needed.

The gearboxes do not serve as part of the frame, but are bolted onto the fully welded mainframe. This ensures that no load and strain from frame will be transmitted by the gearbox, adding to significantly **longer lifetime**.

The ProLine gearboxes feature **reliable crown and pinion drives** positioned in one housing. The main crown wheel in each gearbox is mounted directly to the casing by means of double bearing. The double bearings on both sides of the hexagonal drive shaft keeps the shaft securely in place, even when operating in **heavy duty wet crop**.

#### Heavy Duty Mainframe Design

The tedders are built around a rugged new box section mainframe, made out of one piece of metal with only one welding seam – for **maximum rigidity**. The frame design is fully enclosed at the top edge for **maximum strength** – an exceptionally **solid design**, which allows the tedders to withstand the most severe loads.

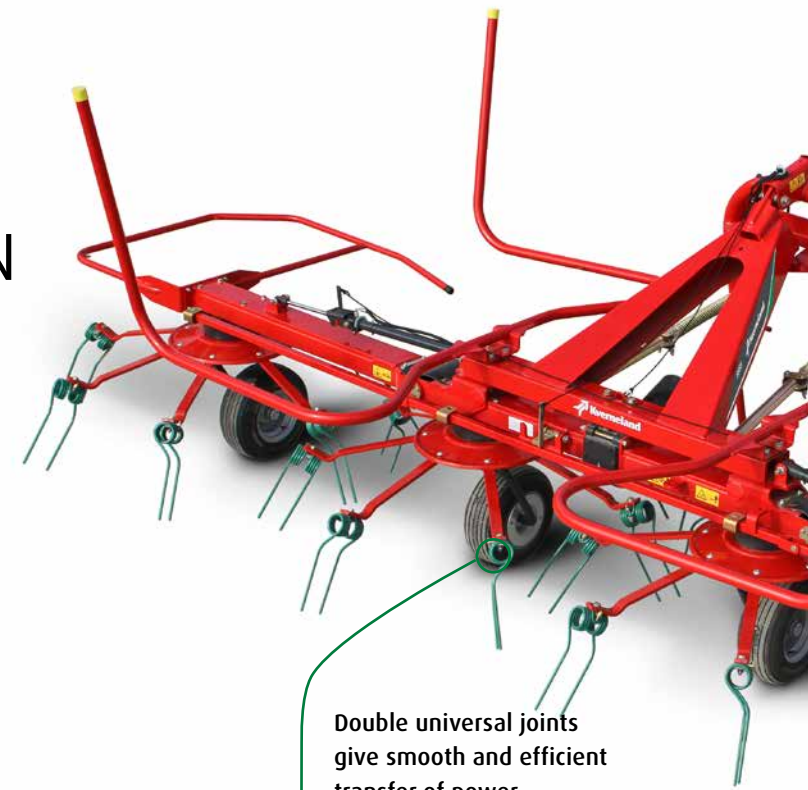

Double universal joints give smooth and efficient transfer of power.

Box shaped mainframe with only one welding seam for maximum rigidity.

Maintenance-free pivoting points with large diameter guarantee a very strong and reliable construction.

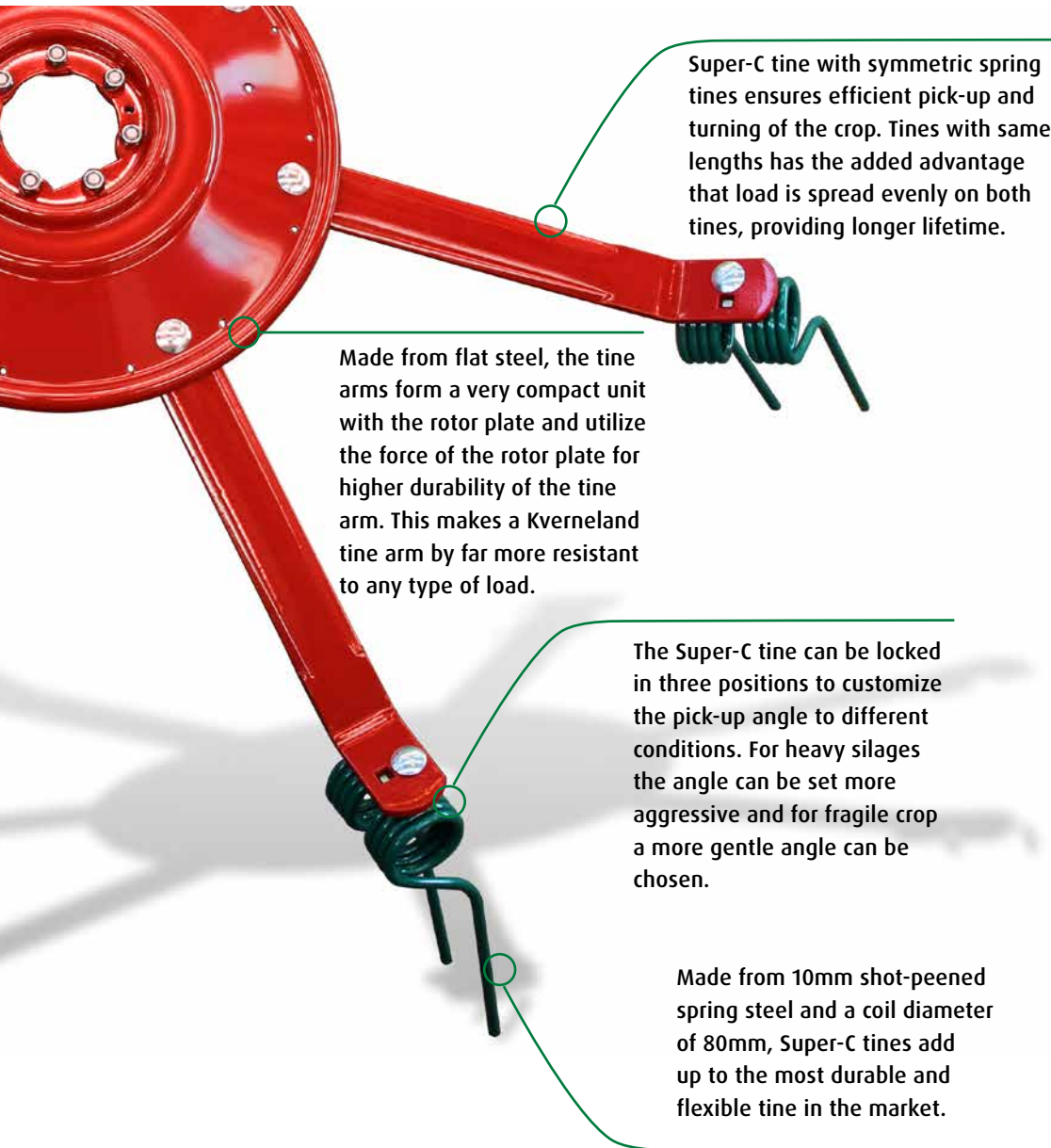

Super-C tine with symmetric spring tines ensures efficient pick-up and turning of the crop. Tines with same lengths has the added advantage that load is spread evenly on both tines, providing longer lifetime.

Made from flat steel, the tine arms form a very compact unit with the rotor plate and utilize the force of the rotor plate for higher durability of the tine arm. This makes a Kverneland tine arm by far more resistant to any type of load.

The Super-C tine can be locked in three positions to customize the pick-up angle to different conditions. For heavy silages the angle can be set more aggressive and for fragile crop a more gentle angle can be chosen.

Made from 10mm shot-peened spring steel and a coil diameter of 80mm, Super-C tines add up to the most durable and flexible tine in the market.

### The Super-C Tine

In order to produce high quality silage or hay, the crop must be spread evenly across the field to facilitate a uniform drying process. In addition soil contamination is a no go. The symmetric Kverneland Super-C tines of identical length efficiently pick up the crop and turn it for a very efficient crop flow. The crop is spread evenly and thrown over a wide distance, to ensure that the wet crop is placed on top of dry crop.

Tines with same lengths has the added advantage that load is spread evenly on both tines, providing longer lifetime.

The Kverneland Super-C tines are made of 10mm shot-peened spring steel. Spring diameter coils have 20% larger diameters than conventional designs for added service life, even when tedding large quantities of crop.



Left: Super C-Tine 10mm  
Right: Standard C-Tine 9mm



# SUPER-C TINES – EVEN SPREAD, CLEAN JOB

## Take the Lead in Beating the Weather

Kverneland tedders help you produce high quality crop, even under **difficult weather circumstances**. Ever changing weather conditions often leave a very tight time window to prepare the crop. When the weather proves to be flexible, it is vital that your gear and equipment is just as **flexible**.

The Kverneland tedders are the right tool to accomplish **uniform and rapid drying** action of the crop. The Kverneland Super-C tines, working with generous overlap thanks to the rotor design, always leave an **airy and evenly spread crop**, speeding up the drying process so you can chop or bale the crop in time. Kverneland tedders allow you to instantly react to unpredictable weather conditions.



Optional third wheel lead to even more accurate track following and better tedding action.



Generous overlap ensures that crop is spread evenly.

## Setting the Right Spreading Angle

Simple **three-way adjustment** of wheel height, allows the optimum spreading angle to be achieved according to crop conditions, helping you to produce high quality forage.

Setting the rotors to the right spreading angle will considerably **improve the spreading action** and speed up the drying process. Set a steep angle for aggressive conditioning effect or choose the more flat angle for more gentle treatment of dry or very fragile material.

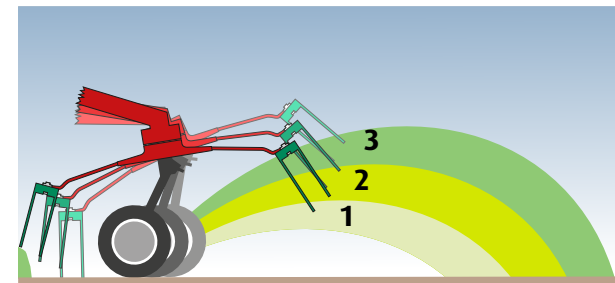

Easy adjustment of spreading angle via pin holes, no tools required.

# PRODUCTIVITY AT THE CORE

in season fully maintenance free



# OSCILLATION DAMPERS FOR SMOOTH AND EVEN CROP DISTRIBUTION

## Oscillation Dampers

The Kverneland oscillation dampers ensure **excellent ground contour following** and tedder flotation. The construction of the oscillation dampers results in a **smooth and even distribution** of the grass, due to the constant tine distance to the ground. The distant linkage point means that it offers **excellent running characteristics** compared to conventional oscillation dampers.

The fact that the linkage is positioned low on the headstock results in a more **effective damping action** during transport.

- Widely spaced mounting points - no risk of 'hunting'
- Excellent running characteristics
- Low-positioned linkage on the headstock for more effective damping action during transport
- No risk of the tedder mounting up driving downhill, excellent tedding at all times through constant tine spacing to the ground
- Maximum stability in transport position - no further lock of headstock required.

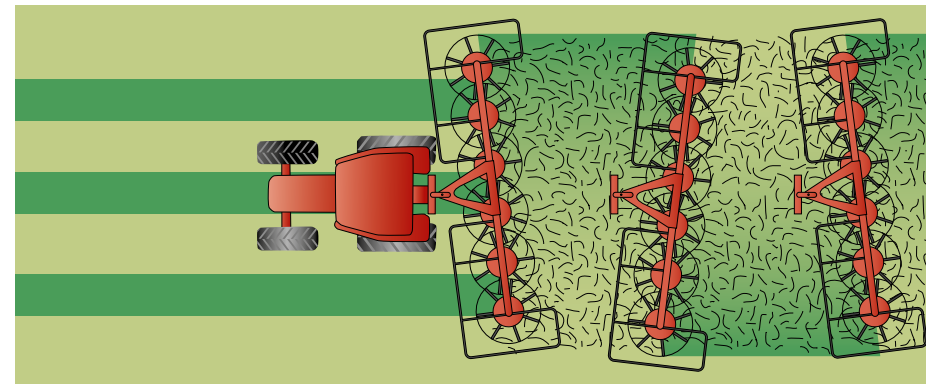

Conventional systems

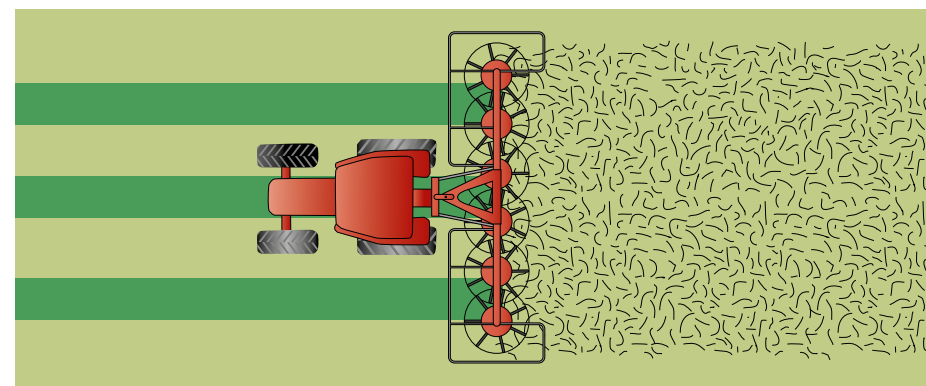

Kverneland oscillation dampers



## EFFICIENCY AND STABILITY

reliable gearbox for long life-time

# KVERNELAND PROLINE GEARBOX SERIES

## HEAVY DUTY DRIVELINE

For delivering the best possible output in the most efficient way, it requires a tedder that is made for **all conditions**. You need an easy but also robust machine that gets the job done to your satisfaction.

The ProLine Gearboxes are built to handle this demands to guarantee **continuous productivity**. Additionally supported by the Super-C-tines delivering a clean job.

### *The Product Range:*

#### **Kverneland 8555**

5.50m working width  
Number of rotors: 4

#### **Kverneland 8563**

6.80m working width  
Number of rotors: 6

#### **Kverneland 8576**

7.60m working width  
Number of rotors: 6

#### **Kverneland 8590**

9.00m working width  
Number of rotors: 8

#### **Kverneland 8590 C**

9.00m working width  
Number of rotors: 8

#### **Kverneland 85112**

11.20m working width  
Number of rotors: 10

#### **Kverneland 85112 C**

11.20m working width  
Number of rotors: 10

#### **Kverneland 85140 C**

13.30m working width  
Number of rotors: 10

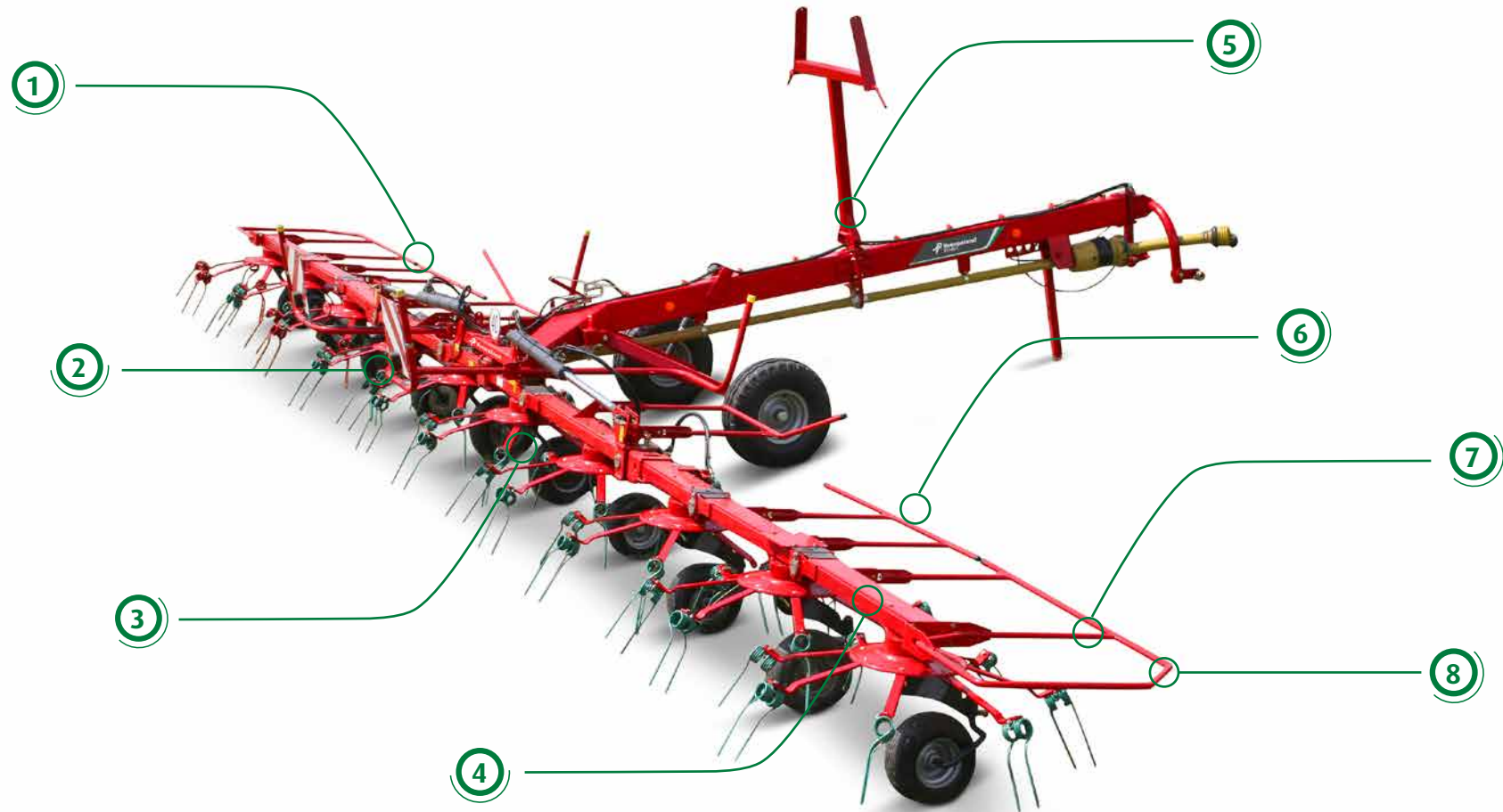

**1** **Unique transport solution** with outer rotors folded onto the carrier frame.

**2** **The carrier frame design** limits the tractor size needed.

**3** **Hydraulically adjustable border tedding** via two or three outer, right hand side rotors.

**4** **7 tine arms per rotor** for optimal pick-up and distribution of material.

**5** **10mm strong tines** with 80mm coil diameter.

**6** **Maintenance-free** ProLine gearbox.

**7** **Wide track width** of 2.00m ensures stability.

**8** **Box type frame** composed of two U-sections for extremely solid construction.

# IT'S ALL ABOUT PERFORMANCE WITH THE 85140 C!



For border tedding the outer rotors are pivoted, to secure evenly inward spreading.

## Sheer Efficiency

The 85140C offers a big dimension in **efficiency and stability**. 10 rotors with 7 tine arms each, can neatly spread four 3.00m swaths. The solid design is your guarantee of a **long lifetime**, even when working in the toughest conditions. Its' large gears, sturdy shock proof bearings and oil-immersed drive system require zero lubrication.

## Easy Handling

This easy to use machine is operated **fully hydraulically** and can be controlled from the tractor cab. High ground clearance and a wide wheelbase provide absolute road stability at high transport speeds. The folding mechanism and conversion to border tedding is hydraulic, and controlled from the tractor seat.

## Minimum Maintenance

All vital parts are enclosed in a permanent oilbath for extreme **durability and stability**. The bearings offer a further innovation, with which the individual framework construction units are connected. The roller bearings of Kverneland 85140 C are life span lubricated. This absolutely maintenance-free kind of storage guarantees maximum stability and life span.



80° turning angle ensures excellent manoeuvrability.



Strong and stable wheels for transport.





# UNIQUE TRANSPORT SOLUTION

## Transport Height of Only 3.35m

Kverneland 85140 C offers a **unique transport solution** that improves total work of the tedder. In transport position the outer rotors are folded forward onto a carrier frame. In this way transport height for 85140 C is only 3.35m, and a transport width of less than 3.00m is achieved.

The carrier frame allows the tedders to move forward **quickly and easily** when going from one field to another. This not only saves time but improves the total efficiency of the tedding process.



Excellent ground tracking, even in very uneven terrain.



During transport it has a height of only 3.35m and a width below 3.00m.



Fast and efficient conversion from transport to working position.



# MINIMUM MAINTENANCE PROMOTES HIGH UPTIME

## 11.2m Working Width

From heavy duty silage to hay making, the Kverneland 85112 is designed to provide an excellent spreading job, significantly **speeding up the drying process**. Delivering 11.2m working width from 10 rotors, each fitted with 6 tine arms per rotor, the result is **high performance** and output. Featuring a heavy duty fully closed headstock, the Kverneland 85112 fits perfectly into the operation of professional farmers, looking for a strong, productive and **versatile tedder**.



Kverneland 85112 is fitted with the new XL version of HexaLink finger clutch providing reliable power transfers and 180° folding of the rotors for transport.

## New Folding Mechanism and Compact Transport Dimensions

The largest in the Kverneland range of mounted rotary tedders comes with a new folding mechanism, providing extra stability when folding on uneven terrain. This ensures **even weight distribution** during the complete folding sequence. Thanks to the new Kverneland HexaLink finger clutch system, the Kverneland 85112 folds into very **compact transport and storage dimensions**. Despite its impressive working width of 11.2m, this rotary tedder offers storage height as low as 3.8m and a transport width of only 2.95m.



Tight turning angle ensures excellent maneuverability.



Compact transport dimensions of Kverneland 85112 – storage height is only 3.8m.



The optional hydraulic headland kit easily stabilises the tedder during headland turning.

## 9M OR 11.2M WORKING WIDTH WITH TRACTORS STARTING FROM 60HP



Tandem axle (option).



Optionally available with hydraulic pre-selection of main functions.

### A Transport Solution Built to Take a Beating

The Kverneland 8590 C with 9m and 8-rotors and the new 85112 C with 11.2m and 10-rotors are carrier frame tedders purpose-built for use with smaller tractors. The wide track width ensures stable running characteristics during road transport. Due to the carrier frame concept, the lifting capacity of the tractor is not a limiting factor and it can be operated with tractors starting from 60hp.



New optional third wheel with tandem axle for high accuracy in ground followings.

In road transport, tedder weight rests on the running gear, rather than on the tractor's rear axle. The optimised driveline provides low input requirement, so you can easily use a small tractor and still work at wide working widths - the ideal solution that saves fuel and running costs.

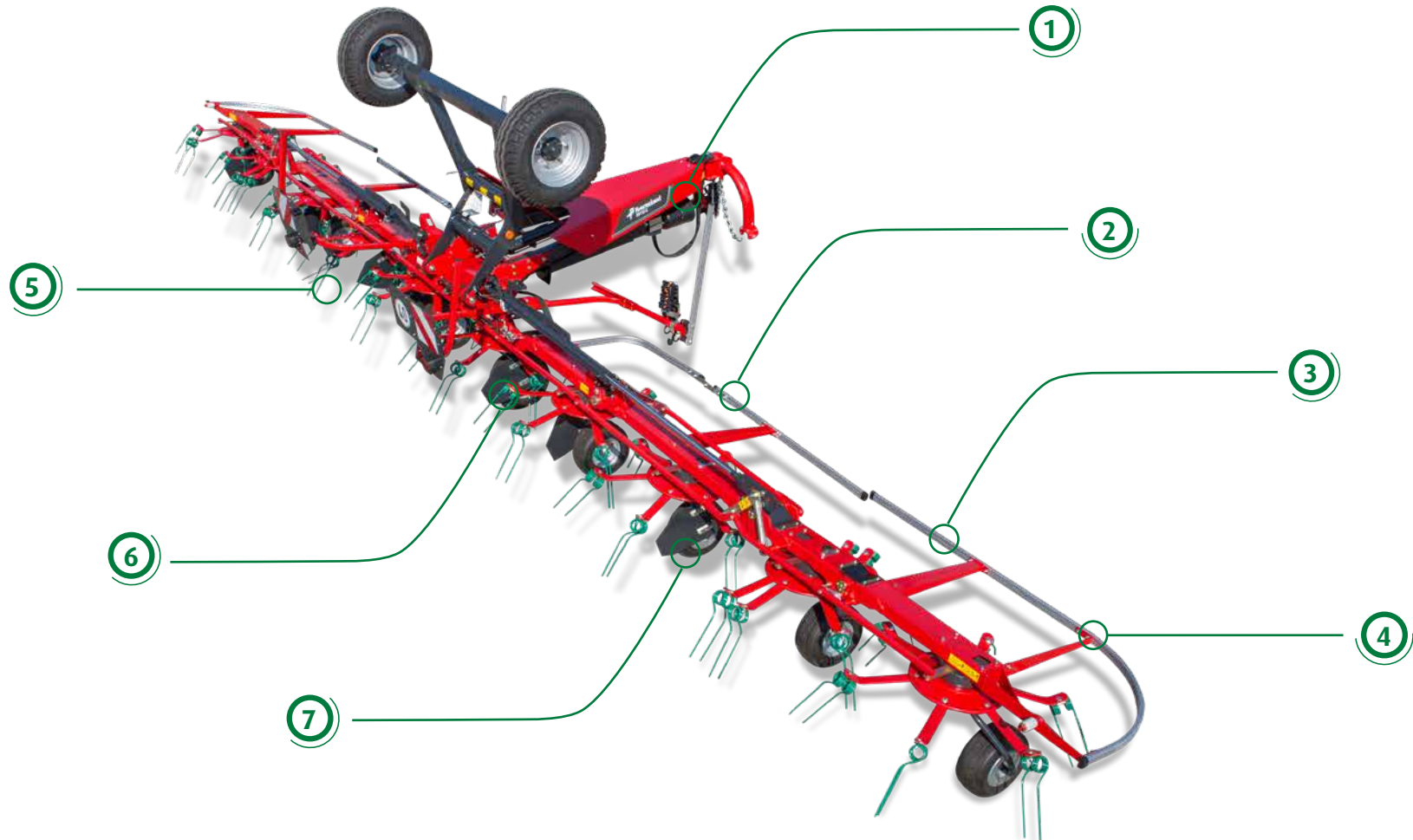

**1** **Reliable driveline** with a strong combination of maintenance free universal joints and HexaLink finger clutch.

**2** **Transport running gears** for use with smaller tractors.

**3** **Central adjustment** for border tedding – all set from the tractor cab.

**4** **Maintenance-free** driveline and ProLine gearbox.

**5** **Strong design** with closed V-shaped central unit allows high transport speed.

**6** **CNC bend frame** with only one welding seam.

**7** **Wide tracks** of 2.45m ensures high stability during transport.

## RELIABLE PERFORMANCE WITH SMART TRANSPORT SOLUTION



### Compact Transport Dimensions

The carrier frame concept of Kverneland 8590 C & 85112 C allows it to be managed using smaller tractors than conventional designs. These models offers very compact **storage and transport heights**: 8590 C = 3.74m / 85112 C = 3.94m due to the implementation of the HexaLink finger clutch system in the joints of the two outer rotors. The remaining rotors are driven by maintenance-free universal joints, for **strong and efficient transfer of power**, including the possibility of running in folded position.



1.-3. Kverneland 8590 & 85112 C easily converts from transport to working position and fold hydraulically.

4. Standard running wheels are extra wide 10.0/75 - 15.3 tyres with a generous track width of 2.45m.

# PRODUCTIVITY

## AT THE CORE WITH MOUNTED MODELS



### Maintenance Made Easy

Powered by maintenance-free driveline and gearboxes, focus can be directed towards the essentials to **maximize productivity**. No time is wasted on time consuming greasing. Additionally the hinges are connected with strong maintenance-free roller bearings for extended **longevity and stability** of the connection points.

### High Quality Tedding in all Conditions

The tine arm design, with flat steel tine arms, ensures that **high loads** can be transferred without any bending of the arms, leading to perfect tedding of even the heaviest crop. Additionally the strong oscillation dampers provide **stable and accurate running** characteristics, leading to an even spreading pattern across the complete working width. All standard settings, like rotor and tine angle adjustment and setting for border tedding is easily done.

### Heavy Duty Confidence

Kverneland's new generation of mounted tedders is designed to **perform** perfect in **all crop conditions**, with a minimum of non-productive maintenance required and with diminished transport dimensions. The range of mounted ProLine tedders includes 5.5m, 6.8m, 7.6m, 9.0m and 11.2m versions. Featuring a heavy duty fully closed headstock and a strong V-shaped central unit, these machines will fit perfectly into the operation of **professional farmers**, looking for a strong, effective, and versatile tedder.



All tedders can be equipped with a third wheel to ensure correct set-up of the tedder independent from tractor and driver.



Strong and sturdy mainframe design with V-shaped central unit.



Aluminium rail guards, which are low in weight, but still extremely impact resistant.



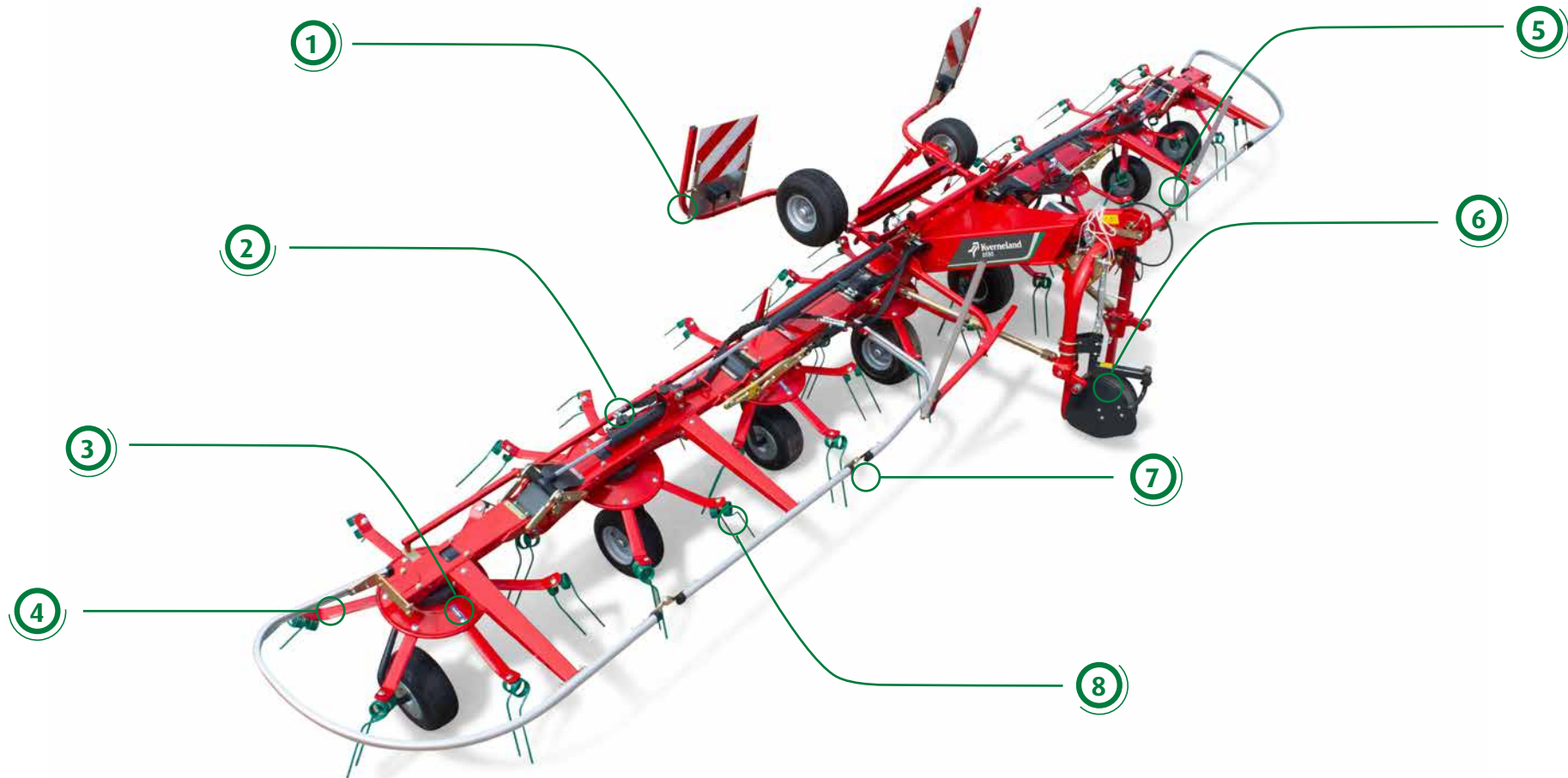

**1** **Reliable driveline** with a strong combination of maintenance free universal joints and HexaLink finger clutch.

**2** **Compact transport** measures with storage heights of only 3.45-3.52m.

**3** **Maintenance-free** driveline and ProLine gearbox.

**4** **Largely dimensioned oscillation dampers** for excellent running characteristics.

**5** **Central adjustment** for border tending - all set from the tractor cab.

**6** **Strong design** with closed V-shaped central unit allows high transport speed.

**7** **Pivoting 3-point headstock** for easy turning and adjustment for border tending.

**8** **CNC bend frame** with only one welding seam.



1. Kverneland HexaLink finger clutch permits a 180° folding of the rotors for transport. (Kverneland 8576 and 8590)

2. Kverneland 8590 in transport.

3. Compact in transport and during storage thanks to the new clever folding mechanism.

# REDUCED TRANSPORT HEIGHT – INCREASED EFFICIENCY

## Compact Transport Dimensions

These ProLine tedders offer very compact transport dimensions with their new **clever folding solution**. A parking height is possible, due to the implementation of the new HexaLink finger clutch system in the joints of the two outer rotors (Kverneland 8576, 8590 and 85112)). The remaining rotors are driven by double acting foldable cylinders\*. They provide **safe unfolding** under all conditions.

\* Except 8555



A hydraulic headland kit is optionally available.\*



To increase productivity these tedders are equipped with a mechanical border tedding device. Optionally a hydraulic solution is available. A marker shows the position of the axle.



POWER WITH  
EASE

simple set-up and easy adjustment

# KVERNELAND COMPACTLINE GEARBOX SERIES

## THE LOW WEIGHT SOLUTION

Not only a fully equipped machine is guaranteeing you the highest performance. Also easier set-ups with easy adjustment possibility **fulfill your demands**.

The Compact Line synergies to you with a close connection to tractor and a **weight optimized** implement for stable transport and operating. With its maintenance friendly drive-line and gearbox concept it shows additionally up with an **easy to operate** configuration. Finally the very small rotors are especially designed for optimized performance while producing dry hay.

### *The Product Range:*

#### **Kverneland 8446**

4.60m working width  
Number of rotors: 4

#### **Kverneland 8452 T**

5.20m working width  
Number of rotors: 4

#### **Kverneland 8452**

5.20m working width  
Number of rotors: 4

#### **Kverneland 8460**

6.05m working width  
Number of rotors: 6

#### **Kverneland 8480**

8.05m working width  
Number of rotors: 8

# THE HAY MAKING TEDDERS



## Powerful Dimensions

Kverneland 8460 and 8480 come with a **strong package of features**, such as 2 oscillation dampers, strong V-shaped central unit and central adjustment for border tedding. They offer **considerable working widths** with their combination of 6/8 rotors and 6.05m/8.05m working width.

The very small rotors are especially designed for **optimized performance** while producing dry hay. The compact rotors, in combination with a big overlap, ensure complete pick-up of the grass and **equal distribution** over the entire working width. Both tedders are fitted with a central adjustment device for setting the machine at the correct angle for border tedding. This is set mechanically from the tractor cab and is done in very few seconds. Optionally hydraulic operation is available too.



The strong design of the V-shaped central unit provides high stability during tedding operation and allows high transport speed.



Standard oscillation dampers ensure an even spreading pattern.



Kverneland 8460 folds hydraulically from working to transport position and vice versa.



Easy and simple adjustment of tine angle.

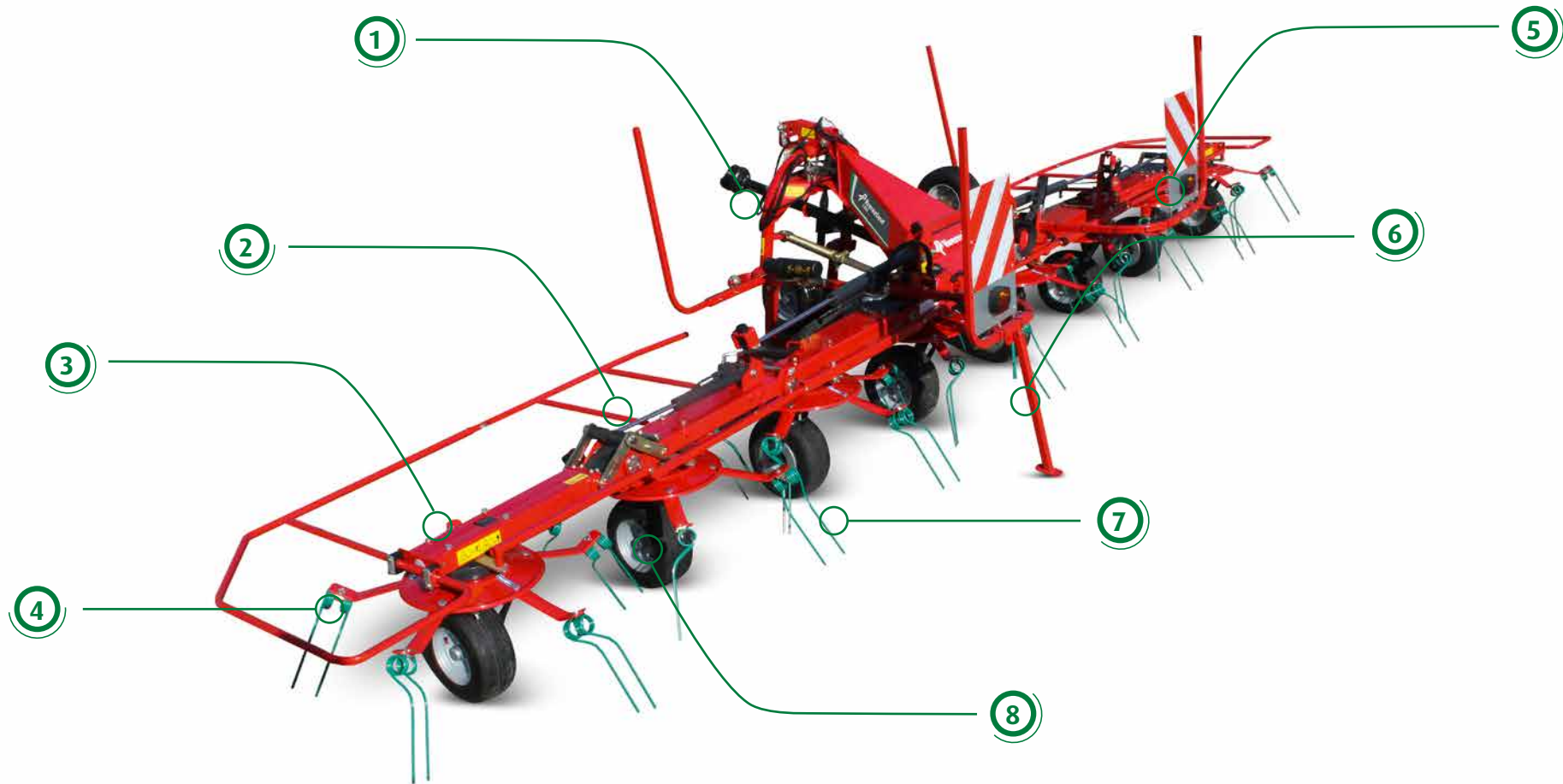

**1** **CNC bend frame** with only one welding seam.

**2** **Pivoting 3-point headstock** for easy turning and adjustment for border tedding.

**3** **Central adjustment** for border tedding - all set from the tractor cab.

**4** **Largely dimensioned oscillation dampers** for excellent running characteristics.

**5** **Strong design** with V-shaped central unit allows high transport speed.

**6** **Low maintenance** CompactLine gearbox with only one grease nipple.

**7** **Optionally** with reduction gearbox for night swaths.

**8** **Fast adjustment** of spreading angle without the use of tools.



Compact folding for transport.



## ACHIEVE MORE WITH KVERNELAND 8480



Kverneland HexaLink finger clutch permits the rotors to fold 180° for transport.



Easy adjustment of spreading angle.



With the optional reduction gearbox it is possible to place night swaths.

### Built to Last – Minimum Maintenance

The Kverneland 8480's superior **durability and ease of maintenance** ensure maximum machine uptime. It is designed with a strong package of Kverneland features such as 2 oscillation dampers and strong V-shaped central frame unit for stable and accurate running characteristics. The rotor gearbox is designed to **just keep going** and only requires greasing once per season, of just one point.

### Compact Folding for Transport

Despite its 8.05m working width the Kverneland 8480 will fold into a **very compact** unit for transport, and will go below 3.00m transport width.

The two outer rotors are fitted with the new Kverneland HexaLink finger clutch, a **simple, yet efficient drive system** that permits these rotors to turn into a 180° position for transport. The remaining rotors are driven by double universal joints, providing sturdy and efficient transfer of power.

# COMPACT

## – EASY TO MAINTAIN



### Low Maintenance

With working widths of 4.60m and 5.20m, Kverneland offers the CompactLine range with **low maintenance** rotor gearboxes. The rotors of the 8446, 8452 and 8452 T are driven by a low maintenance gearbox with only one grease nipple. The double bearings from pinion to crown wheel guarantee **maximum longevity** of the driveline. The low weight of these models is ideal for application with small tractors, or in hilly regions.

### Incredible Dimensions

Even the smallest models excel – the rotor plate diameter measures 500mm! All tedders feature gearboxes flanged to the frame, and which have no supporting function, and are therefore not subjected to any strain. This system sets the benchmark with respect to **stability, smooth running, quality of work and efficiency**. Compare for yourself.

All models are fitted with a **central adjustment device** for setting the machine at the correct angle for border tending. This is set mechanically from the tractor cab and is done in very few seconds. Optionally hydraulic operation is available too.



All tedders fold hydraulically from working to transport position and vice versa.



Keep the crop inside the field with border tending.



Kverneland 8446 and 8452 are centrally adjusted for border tending.

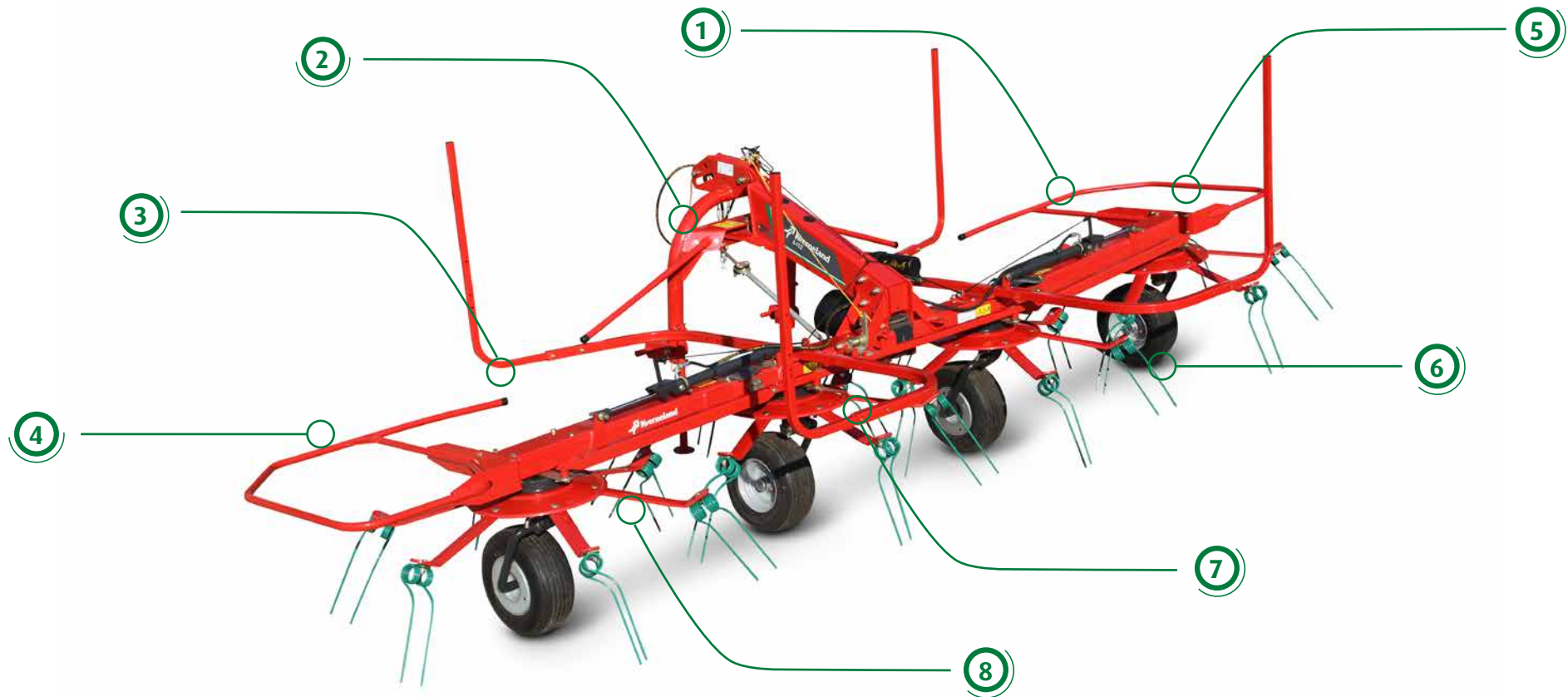

**1** **Fast adjustment** of spreading angle without the use of tools.

**2** **Box type frame** composed of two U-sections for extremely solid construction.

**3** **Low maintenance** CompactLine gearbox with only one grease nipple.

**4** **Optionally** with reduction gearbox for tight swaths.

**5** **Compact tadders** with low weight and power requirements.

**6** **Pivoting 3-point headstock** for easy turning and adjustment for border tedding.

**7** **Central adjustment** for border tedding – all set from the tractor cab.

**8** **Oscillation dampers** for excellent running characteristics.

# ORIGINAL PARTS & SERVICE

## LET'S FOCUS ON YOUR BUSINESS

ORIGINAL  
PARTS

- 
- ① LONG LASTING, HIGH QUALITY SPARE PARTS
  - ② OVER 100 YEARS OF PARTS KNOWLEDGE
  - ③ SUPPORT FROM A WIDE NETWORK OF DEALERS
  - ④ 24/7 SPARE PARTS SERVICE
  - ⑤ HIGHLY SKILLED DEALER TECHNICIANS

# MYKVERNELAND

## SMARTER FARMING ON THE GO

### A personalised online platform tailored to your machine needs

With MYKVERNELAND you will benefit from easy access to Kverneland's online service tools.

Receive first hand access to information on future developments and updates, operator and spare part manuals, FAQs and local VIP offers. All information is gathered in one place.



# TECHNICAL DATA

	CompactLine Tedders					ProLine Mounted Tedders		
Model	8446	8452	8460	8480	8452 T	8555	8568	8576
<b>Dimensions and Weights</b>								
Working width* (m)	4.60	5.20	6.05	8.05	5.20	5.50	6.80	7.60
Working width* (feet)	15'1"	17'1"	19'10"	26'5"	17'1"	18'1"	22'4"	24'11"
Width, working position (m)	5.00	5.40	6.40	8.35	5.40	5.80	7.15	7.90
Width, working position (feet)	16'5"	17'9"	20'12"	27'5"	17'9"	19'	23'5"	25'11"
Transport width (m)	2.85	2.90	2.75	2.80	2.90	2.98	2.92	2.96
Transport width (feet)	9'4"	9'6"	9'	9'2"	9'6"	9'9"	9'7"	9'9"
Transport length (m)	2.85	2.10	1.86	1.90	2.90	2.30	2.20	2.26
Transport length (feet)	7'6"	6'11"	6'1"	9'6"	9'6"	7'7"	7'3"	7'5"
Storage height (m)	2.45	2.65	3.10	3.15	2.65	2.80	3.52	3.46
Storage height (feet)	8'	8'8"	10'2"	10'33"	8'8"	9'2"	11'7"	11'4"
Weight approx. (kg)	500	530	650	920	460	640	900	990
Weight approx. (lbs)	1102	1168	1433	2028	1014	1410	1984	2183
Capacity theor. (ha/h)	3.7	4.2	4.8	6.4	4.2	4.4	5.4	6.1
<b>Linkage</b>								
Pivoting 3-point headstock	Cat. I+II	Cat. I+II	Cat. I+II	Cat. II	-	Cat. II	Cat. II	Cat. II
Tow bar / Hitch	-	-	-	-	●	-	-	-
Two point lower linkage	-	-	-	-	-	-	-	-
Oscillation dampers	●	●	-	●	-	-	-	-
- integr. locking device	-	-	●	●	-	●	●	●
<b>Rotors/Tines/Safety Frames</b>								
Number of rotors	4	4	6	8	4	4	6	6
Number of tine arms per rotor	5	6	5	5	6	7	6	7
Tine loss prevention equipm.	○	○	○	○	○	○	○	○
Spreading angle adjust. (3 pos.)	●	●	●	●	-	●	●	●
Mech. central wheel adjust. for border tedding	●	●	●	●	-	●	●	●
Hydr. central wheel adjust. for border tedding	○	○	○	○	-	○	○	○
CompactLine Gearbox	●	●	●	○	●	-	-	-
ProLine Gearbox	-	-	-	-	-	●	●	●

	CompactLine Tedders					ProLine Mounted Tedders		
Model	8446	8452	8460	8480	8452 T	8555	8568	8576
Wheel/Axles/Light								
Tyres	16x6.5-8	16x6.5-8	16x6.5-8	6x6.5-8	16x6.5-8	16x6.5-8	16x6.5-8	16x6.5-6
Tyres, central unit	-	-	-	-	-	-	-	-
Front gauge wheel	○	○	○	○	-	○	○	○
Anti-wrapping plates	○	○	○	○	○	○	○	○
Carrier frame	-	-	-	-	-	-	-	-
Tandem axles	-	-	-	○	○	○	○	○
Warning panels	○	○	○	○	○	○	○	○
-, with integr. lighting	○	○	○	○	○	○	○	○

- Standard equipment
- Option
- Not available
- \* (DIN 11220)

# TECHNICAL DATA

	ProLine Mounted Tedders		ProLine Carried Tedders		
Model	8590	85112	8590 C	85112 C	85140 C
<b>Dimensions and Weights</b>					
Working width* (m)	9.00	11.20	9.00	11.20	13.30
Working width* (feet)	29'6"	36'8"	29'6"	36'8"	43'8"
Width, working position (m)	9.45	11.70	9.45	11.70	13.80
Width, working position (feet)	31'0"	38'4"	31'0"	38'4"	45'3"
Transport width (m)	2.94	2.95	2.94	2.94	2.98
Transport width (feet)	9'8"	9'68"	9'8"	9'65"	9'9"
Transport length (m)	2.16	2.37	4.21	4.26	6.20
Transport length (feet)	7'1"	7'77"	14'	14'	20'4"
Storage height (m)	3.49	3.80	3.74	3.94	3.35
Storage height (feet)	11'5"	12'43"	12'3"	12'9"	10'1"
Weight approx. (kg)	1260	1600	1700	2225	2300
Weight approx. (lbs)	2778	2788	3747	2788	5071
Capacity theor. (ha/h)	7.2	9.0	7.2	9.0	10.7
<b>Linkage</b>					
Pivoting 3-point headstock	Cat. II	Cat. II	-	Cat. II	-
Tow bar / Hitch	-	-	-	-	-
Two point lower linkage	-	-	Cat. II	-	Cat. II
Oscillation dampers	-	●	-	●	-
- integr. locking device	●	●	-	●	-
<b>Rotors/Tines/Safety Frames</b>					
Number of rotors	8	10	8	10	10
Number of tine arms per rotor	6	6	6	6	7
Tine loss prevention equipm.	○	○	○	○	○
Spreading angle adjust. (3 pos.)	●	●	●	●	●
Mech. central wheel adjust. for border tedding	●	●	-	-	-
Hydr. central wheel adjust. for border tedding	○	○	●	●	●
CompactLine Gearbox	-	-	-	-	-
ProLine Gearbox	●	●	●	●	●



	ProLine Mounted Tedders		ProLine Carried Tedders		
Model	8590	85112	8590 C	85112 C	85140 C
Wheel/Axles/Light					
Tyres	16x6.5-8	16x6.5-6	16x6.5-6	16x6.5-6	16x6.5-6
Tyres, central unit	18x8.50-8	18.5x8.5-8	18.5x8.5-8	18.5x8.5-8	18.5x8.5-8
Front gauge wheel	○	○	○	-	-
Anti-wrapping plates	○	○	○	○	○
Carrier frame	-	-	10.0x75-15	10.0x75-15	10.0x75-15
Tandem axles	○	○	○	-	-
Warning panels	●	●	●	●	●
-, with integr. lighting	●	●	●	●	●

- Standard equipment
- Option
- Not available
- \* (DIN 11220)

Information provided in this brochure is made for general information purposes only and for worldwide circulation. Inaccuracies, errors or omissions may occur and the information may thus not constitute basis for any legal claim against Kverneland Group. Availability of models, specifications and optional equipment may differ from country to country. Please consult your local dealer. Kverneland Group reserves the right at any time to make changes to the design or specifications shown or described, to add or remove features, without any notice or obligations. Safety devices may have been removed from the machines for illustration purposes only, in order to better present functions of the machines. To avoid risk of injury, safety devices must never be removed. If removal of safety devices is necessary, e.g. for maintenance purposes, please contact proper assistance or supervision of a technical assistant. © = trade mark protection in the EU © Kverneland Group Kerteminde AS

# THE RIGHT TEDDER FOR EVERY CUTTING WIDTH

## PROLINE



ProLine	 Rotors	 Rotor width	 Rotor tines	 Working width	
85140 C	10	1760mm	7	13.30m	
85112/85112 C	10	1560mm	6	11.20m	
8590/8590 C	8	1560mm	6	9.00m	
8576	6	1660mm	7	7.60m	
8568	6	1560mm	6	6.80m	
8555	4	1760mm	7	5.50m	

Working width\* / swathes\*\*

1.6m    2.0m    2.4m    2.8m    3.2m    3.5-3.6m    4.0m    8.7m    9.0m    9.5m    10.2m

	1.6m	2.0m	2.4m	2.8m	3.2m	3.5-3.6m	4.0m	8.7m	9.0m	9.5m	10.2m





# THE RIGHT TEDDER FOR EVERY CUTTING WIDTH

## COMPACTLINE

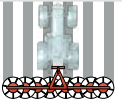
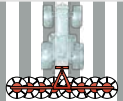
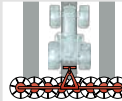
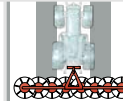
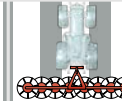
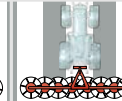
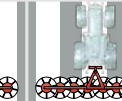
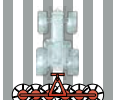
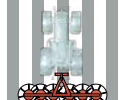
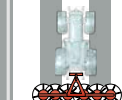

CompactLine	 Rotors	 Rotor width	 Rotor tines	 Working width	
8480	8	1420mm	5	8.05m	
8560	6	1420mm	5	6.05m	
8452	4	1660mm	6	5.20m	
8452 T	4	1660mm	6	5.20m	
8446	4	1560mm	5	4.60m	

Working width\* / swathes\*\*

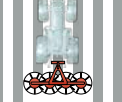
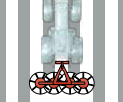
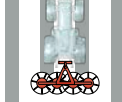
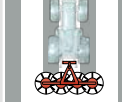
	1.6m	2.0m	2.4m	2.8m	3.2m	3.5-3.6m	4.0m	8.7m	9.0m	9.5m	10.2m
											
											
											
											
											

\*only full working width covering pictured

\*\*based on average swath width





**WHEN FARMING MEANS BUSINESS**

[kverneland.com](https://kverneland.com)