

# Owner / Operator Manual

For use with models having serial numbers with “B” as the **FOURTH** digit:  
Example: 826B0001

# Brown 826-2 Brush Cutter

**ATTENTION:**  
ALL WARRANTY WORK **MUST BE APPROVED**  
BY BROWN MFG. CORP.  
**BEFORE WORK BEGINS**

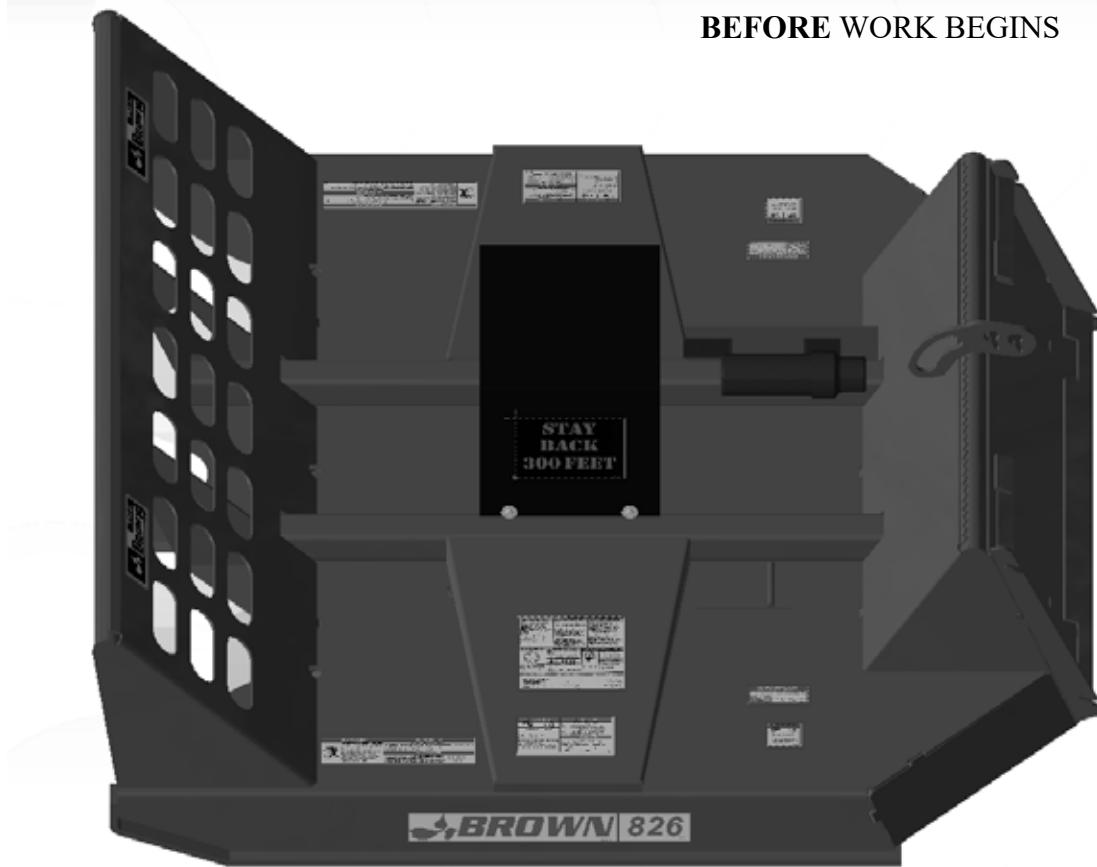

**⚠ DANGER DO NOT OPERATE WITHOUT SHATTERPROOF CAB DOOR DANGER ⚠**



**Lift Restriction Chains** must be attached from the skid loader to the brush cutter to keep the cutter below the level of the operator **BEFORE** operating this machine. See **Page 17** for further information.



**HEAVY DUTY SINCE 1944**

6001 E. Hwy 27 - Ozark, AL 36360  
334.795.6603 - Fax: 334.795.3029

[www.brownmfgcorp.com](http://www.brownmfgcorp.com)

<b>⚠ WARNING</b>	
	Before operating your machine, stop and read this owners manual. Do not attempt to operate the unit until you fully understand the material covered in this manual. Without the knowledge contained in this manual, injury or death can result.

**Copyright Information**

Copyright ©2017 Brown Manufacturing Corporation, Ozark, Alabama. All photos and illustrations are property of Brown Manufacturing Corporation. This publication may be freely reproduced, either in whole or in part, provided that the content herein is not altered. We encourage you to make copies of this manual and to distribute it to every operator of the machine. Additional copies are also available from Brown Manufacturing Corporation at no charge.

**Cover**

Illustrated: Brown 826

**Disclaimer**

Due to engineering improvements and revision of product specifications, the information contained in this manual is subject to change without notice.

## Contents

<b>Owner Registration.....</b>	<b>5</b>
<b>Important Notice:.....</b>	<b>6</b>
<b>Equipment Safety.....</b>	<b>7</b>
<b>Attaching Cutter/Hose Diagram.....</b>	<b>16</b>
<b>Cutting Height.....</b>	<b>17</b>
<b>Starting Cutter Operations.....</b>	<b>18</b>
<b>Operating Instructions.....</b>	<b>21</b>
<b>Maintenance.....</b>	<b>25</b>
<b>Blade Installation.....</b>	<b>30</b>
<b>Blade Bar Removal Technique.....</b>	<b>31</b>
<b>Blade Bar Installation Procedure.....</b>	<b>32</b>
<b>Maintenance Log.....</b>	<b>34</b>
<b>Troubleshooting.....</b>	<b>36</b>
<b>Specifications.....</b>	<b>37</b>
<b>Replacement Parts.....</b>	<b>38</b>

## Warranty Statement

### LIMITED WARRANTY

BROWN MANUFACTURING CORP. hereby warrants that Brown's products will be free from defects in material and workmanship under normal use according to the provisions and limitations herein set forth. All parts, specifically EXCLUDING expendable 'wear' parts, that become unserviceable, due to defective material or workmanship, within three months / 90 days from date of the original retail purchase, shall, at Brown's option, be repaired or replaced.

### LIMITATIONS

The obligations of Brown for breach of warranty shall be limited to products manufactured by Brown; (1) that are installed, operated, and maintained according to Brown's instruction furnished and/or available to the purchaser upon request; (2) that are installed according to all other applicable Federal, State, and local codes or regulations; and (3) that the purchaser substantiates were defective in material and workmanship notwithstanding that they were properly installed and correctly maintained as set forth and were not abused or misused. The obligation of Brown shall be limited to replacing or repairing the defective product, at the option of Brown. Brown shall not be responsible for any labor or cost of removal or repairing or reinstallation of its products and shall not be liable for transportation costs to and from its plant in Ozark, Alabama. Use of parts for modification or repair of the product or any component part thereof not authorized or manufactured by Brown specifically for such product shall void this warranty. This warranty shall not apply to any damage to or defect in the Brown's products that is directly or indirectly caused by; (1) FORCE MAJEURE, act of GOD, or other accident not related to an inherent product defect; or (2) abuse, misuse, or neglect of the such product, including any damage caused by improper assembly, installation, adjustment, or faulty instruction of the purchaser. **OTHER THAN AS EXPRESSLY SET FORTH HEREIN ABOVE, BROWN MAKES NO OTHER WARRANTY, EXPRESS OR IMPLIED, WITH RESPECT TO ANY OF BROWN'S PRODUCTS, INCLUDED BUT NOT LIMITED TO ANY MERCHANTABILITY OR FITNESS FOR A PARTICULAR PURPOSE. IN NO EVENT SHALL BROWN BE RESPONSIBLE FOR ANY INCIDENTAL OR CONSEQUENTIAL DAMAGES OF ANY NATURE SUFFERED BY PURCHASER OR ANY OTHER PERSON OR ENTITY CAUSED IN WHOLE OR IN PART BY ANY OF BROWN'S PRODUCTS.** Any person or entity to whom this warranty extends and who claims breach of warranty against Brown must bring suit thereon within one year from the date of occurrence of such breach of warranty or be forever barred from any and all legal or other remedies for such breach of warranty. Brown is not responsible for and hereby disclaims any undertaking, representation, or warranty made by any dealer, distributor, or other person that is inconsistent with or in any way more expensive than the provisions of this limited warranty. This warranty grants specific legal rights and shall be read in conformity with applicable state law. In some jurisdictions, the applicable law mandates warranty provisions that provide greater rights than those provided for herein. In such case, this limited warranty shall be read to include such mandates provisions; and any provision herein that is prohibited or unenforceable in any such jurisdiction shall, as to such jurisdiction, be ineffective to the extent of such prohibition or unenforceable without invalidating the remaining provisions and without affecting the validity or enforceability of such provisions in any other jurisdiction.

### STATEMENT OF POLICY

In accordance with our established policy of constant improvement, we reserve the right to amend these specifications at any time without notice.

### WARRANTY BY MANUFACTURER

Dealer/distributor understands and agrees that the manufacturer extends only the following warranty to its customers. In the event dealer/distributor extends any additional warranty such as enlarging the scope or period of warranty or undertaking a warranty of fitness for any particular purpose or obligation not encompassed in manufacturer's warranty, dealer/distributor shall be solely responsible therefore and shall have no recourse against manufacturer with respect thereto.

# Owner Registration

## WARRANTY NOTES

- All parts returned to Brown Manufacturing Corp. for warranty inspection must be received freight prepaid.
- If a warranty claim is approved, replacement or repaired parts will be returned to the customer freight prepaid.
- If a dealer makes any type of approved warranty repair, only parts and labor will be credited by Brown Manufacturing Corp. **No service call or transportation charges are warrantable.**
- No returned parts will be inspected for warranty claims if not received with a Return Authorization Number. **Without an RA#, Brown Manufacturing Corp. cannot and will not be responsible for any returned goods.**
- Use of any replacement parts other than original Brown replacement parts will void all warranties.**

**⚠WARNING:** The use of aftermarket replacement parts will change the operational conditions of the machine, shorten the life of other components, lead to failure of the machine, and create safety hazards to all persons near the machine. Brown equipment is designed to use OEM replacement parts meeting the exact specifications of the machine and crafted from high-quality materials. Aftermarket replacement parts are neither engineered to meet the machine's exact specifications nor manufactured to the same high standards as original Brown replacement parts.

### For Your Records

Model: \_\_\_\_\_  
 Serial No.: \_\_\_\_\_  
 Date Purchased: \_\_\_/\_\_\_/\_\_\_  
 Dealer: \_\_\_\_\_  
 Date Registered: \_\_\_/\_\_\_/\_\_\_

### Owner Registration



**Important:** To place the manufacturer's warranty into effect, this card must be mailed within thirty (30) days after receiving equipment.

**Return to:**  
 Brown Manufacturing Corp.  
 6001 E. Hwy 27  
 Ozark, AL 36360

Name: \_\_\_\_\_  
 Address: \_\_\_\_\_  
 City: \_\_\_\_\_ State: \_\_\_\_\_  
 Model: \_\_\_\_\_  
 Serial No.: \_\_\_\_\_  
 Date Purchased: \_\_\_/\_\_\_/\_\_\_  
 Dealer: \_\_\_\_\_

## Important Notice:

### OWNER'S MANUAL STORAGE CONTAINER

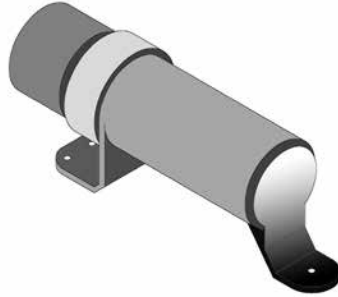

\* Brown Manufacturing provides an Owner's Manual holder on all equipment.  
\*This holder is mounted in a convenient location and provides the owner with the proper safety and operation information.

\*Two (2) copies are provided with each unit.

\*One copy is for the **owner** for review and maintenance of the equipment.

\*Second copy is to stay with the unit at all times. This provides the **operator** the information needed for safe and proper operation of the unit.

\*If the Owner's Manual becomes lost or damaged, contact Brown Manufacturing Corp. or your local Brown dealer for free replacement. The manual is also available for digital download from our website.

[www.brownmfgcorp.com](http://www.brownmfgcorp.com)



**Please use envelope.**

## Equipment Safety



**Warning: Read this manual before operation.**

Operators of the equipment must read and understand this manual. Failure to read this manual and follow these safety and operating instructions could result in serious bodily injury or even death.

 <b>WARNING</b>	
	<p>Before operating your machine, stop and read this owners manual. Do not attempt to operate the unit until you fully understand the material covered in this manual. Without the knowledge contained in this manual, injury or death can result.</p>

**Each operator of the equipment should review this manual every six (6) months.** You are encouraged to duplicate this manual and to distribute it to each operator of the equipment for their training and reference. Additional copies are available from Brown Manufacturing Corporation at no charge.

### **POTENTIAL DANGER AREAS OF ALL BRUSH CUTTERS**

1. EXPOSED ROTATING BLADES
2. MATERIAL DISCHARGE
3. PRESSURIZED HYDRAULICS
4. PINCH POINT
5. HOT SURFACES

# Equipment Safety

## Recognize safety information

This is the safety alert symbol. When you see this symbol on your equipment or in this manual, be alert to the potential for personal injury or injury to others.



## Understand signal words

**DANGER** indicates an imminently hazardous situation which, if not avoided, will result in death or serious injury



**WARNING** indicates a hazardous situation which, if not avoided, could result in serious injury or death.



**CAUTION** indicates a potentially hazardous situation which, if not avoided, may result in minor or moderate injury.



**NOTICE** indicates information considered important but not directly hazard related. (e.g. security, hygiene, equipment or property damage).



## Follow safety instructions

- Read owner/operator manual.
- Replace missing or damaged safety decals.
- Safety decals and this manual must be considered a permanent part of your equipment.
- Should ownership of the equipment be transferred, this manual must also be transferred.
- Unauthorized modifications to the equipment are not recommended. This could impair the function, safety, and life of the machine.
- For any part of this manual that you do not understand, contact your dealer or Brown Manufacturing Corporation at (800) 633-8909.
- All implements with moving parts are potentially dangerous. Due to this fact, there is no substitute for a safe, knowledgeable operator. It is important that all persons operating this equipment read, understand, and follow the instructions provided in this manual.

**DO NOT OPERATE THIS UNIT IF YOU ARE UNDER THE INFLUENCE OF ALCOHOL, ILLEGAL DRUGS, OR ANY PRESCRIPTION OR OVER THE COUNTER MEDICATIONS THAT COULD CAUSE DROWSINESS, DIZZINESS, DISORIENTATION AND/OR IMPAIR YOUR ABILITY IN ANY WAY TO SAFELY OPERATE THE UNIT.**

**DO NOT OPERATE THIS UNIT IF YOU SUFFER FROM ANY PHYSICAL CONDITION OR DISABILITY THAT WOULD IMPAIR YOUR ABILITY TO OPERATE IT SAFELY.**



# Equipment Safety

## Safety Decals

The following safety decals should be attached to the equipment at all times. Should any decals become damaged or lost, it is the responsibility of the owner to replace it. Additional decals may be obtained from the dealer or Brown Manufacturing Corporation at no charge.

<b>⚠ WARNING</b>	<b>⚠ ADVERTENCIA</b>	<b>⚠ AVERTISSEMENT</b>	
<p>To prevent serious injury or death:</p> <ul style="list-style-type: none"> <li>• Read and understand Operator's Manual before using.</li> <li>• Do not permit riders on the tractor or cutter. Never carry child on tractor seat.</li> <li>• Operate with guards installed and in good condition.</li> <li>• Operate only with tractor equipped with ROPS and seatbelts.</li> <li>• Keep away from moving parts.</li> <li>• Stop engine, set brake and wait for all moving parts to stop before dismounting.</li> <li>• Be sure lights and reflectors required by law are clean and in good working order before transporting.</li> <li>• Do not allow children to operate cutter.</li> <li>• Travel with SMV and lights that follow local codes.</li> <li>• Clear debris from cutting area.</li> <li>• Do not operate in the raised position.</li> <li>• Support securely before working beneath unit.</li> <li>• Review safety instructions annually.</li> </ul>	<p>Para prevenir lesiones graves o de accidentes mortales:</p> <ul style="list-style-type: none"> <li>• Léan y asimilen el Manual del Usuario antes de probar la máquina.</li> <li>• No permitan pasajeros ni en la cortadora ni en el tractor. Nunca lleven consigo a un niño en el asiento del tractor.</li> <li>• Debe manejarse con los resguardos puestos y en buen estado.</li> <li>• No la enganchen si no es a un tractor equipado de su blindaje de protección y del cinturón de seguridad.</li> <li>• No se acerquen a las piezas en movimiento.</li> <li>• Paren el motor, echen el freno y esperen a que todos los órganos que estén en movimiento se paren antes de bajarse del tractor.</li> <li>• Asegúrense que las luces y los reflectores estén limpios y en buen estado antes de iniciar la tarea.</li> <li>• No permitan a los menores poner la cortadora en marcha.</li> <li>• Observen los reglamentos locales en lo tocante a la iluminación y velocidad de los vehículos lentos.</li> <li>• Limpíen de desperdicios el área que vayan a cortar.</li> <li>• No utilicen la cortadora en la posición elevada.</li> <li>• Soporten, bloqueando con seguridad, el equipo antes de ponerse a trabajar por debajo de él.</li> <li>• Releán las instrucciones sobre la seguridad anualmente.</li> </ul>	<p>Prévenir les blessures graves et la mort:</p> <ul style="list-style-type: none"> <li>• Lire et comprendre le manuel du propriétaire avant de faire fonctionner la machine.</li> <li>• Il est interdit de prendre des passagers sur la coupeuse ou le tracteur. Il est interdit de prendre un enfant avec soi sur le tracteur.</li> <li>• Tous les gardes doivent être posés et en bon état.</li> <li>• N'atteler que sur un tracteur équipé d'une cage de protection et de ceinture de sécurité.</li> <li>• Rester éloigné des pièces en mouvement.</li> <li>• Arrêter le moteur, serrer les freins et attendre que toutes les pièces en mouvement se soient immobilisées avant de descendre du tracteur.</li> <li>• S'assurer que les feux de circulation et les réflecteurs sont propres et en bon état avant de prendre la route.</li> <li>• Interdire aux enfants de faire fonctionner la coupeuse.</li> <li>• Respecter les lois locales régissant les véhicules lents et leur signalisation.</li> <li>• Débarrasser la section à couper de tous les débris.</li> <li>• Interdit de faire fonctionner en position relevée.</li> <li>• Bloquer de façon sécuritaire avant de travailler sous la machine.</li> <li>• Relire les consignes de sécurité annuellement.</li> </ul>	
<b>⚠ CAUTION</b>	<b>⚠ PRECAUCIÓN</b>	<b>⚠ WARNING</b>	<b>⚠ ADVERTENCIA</b>
	<p>En evitación de lesiones y de averías de todo tipo:</p> <ul style="list-style-type: none"> <li>• Utilicen siempre los útiles y herramientas apropiados para el mantenimiento de la máquina.</li> <li>• Léan las instrucciones del manual del usuario.</li> </ul>		<p>Antes de probar la cortadora por primera vez deben remitirse a las instrucciones contenidas en el manual.</p>
<b>⚠ ATTENTION</b>		<b>⚠ AVERTISSEMENT</b>	
<p>To Avoid Injury Or Machine Damage:</p> <ul style="list-style-type: none"> <li>• When servicing machine use proper tools and equipment.</li> <li>• Refer to operations manual for instructions.</li> </ul>	<p>Dans le but d'éviter les blessures et les dommages à la machine:</p> <ul style="list-style-type: none"> <li>• Toujours utiliser les outils et équipements appropriés à l'entretien la machine.</li> <li>• Consulter les marches à suivre au manuel du propriétaire.</li> </ul>	<p>Read and understand owner's manual before operating cutter.</p>	<p>S'assurer de bien comprendre toutes les consignes du manuel du propriétaire avant d'utiliser la coupeuse.</p>
<b>⚠ DANGER</b>	<b>⚠ PELIGRO</b>	<b>⚠ DANGER</b>	
<p>Tighten blade bolts as prescribed in owner/operator's manual.</p> <p>Do not operate this unit if you suffer from any physical condition or disability that would impair your ability to operate it safely.</p> <p>Do not operate this machine if you are under the influence of alcohol or any drug that could impair your ability to operate the unit in a safe manner.</p>	<p>Los pernos que sujetan la cuchilla deben apretarse como se indica en el manual.</p> <p>No opere esta unidad si tiene algún tipo de discapacidad o afección física que afecte su capacidad para operar de forma segura.</p> <p>No opere esta máquina bajo los efectos del alcohol o cualquier droga que puede afectar su capacidad para operar la unidad de forma segura.</p>	<p>Serrer les boutons des lames selon les consignes du manuel du propriétaire/opérateur.</p> <p>Ne pas utiliser cette unité si vous souffrez d'une affection ou d'une incapacité physique susceptible de nuire à la capacité d'utiliser le produit en toute sécurité.</p> <p>Ne pas utiliser cet appareil sous l'influence de l'alcool ou de drogues susceptibles de nuire à la capacité d'utiliser le produit en toute sécurité.</p>	

**⚠ WARNING**

**HIGH-PRESSURE FLUID HAZARD**

To prevent serious injury or death:

- Relieve pressure on system before repairing or adjusting or disconnecting.
- Wear proper hand and eye protection when searching for leaks. Use wood or cardboard instead of hands.
- Keep all components in good repair.

237-0002

## IMPORTANT

ALL NUTS, BOLTS, AND OTHER FASTENERS MUST BE KEPT TIGHT AT ALL TIMES. FAILURE TO DO SO VOIDS WARRANTY.

6001 E. Hwy 27, OZARK, AL. 36360  
(334) 795-6603

SD-020

# Equipment Safety

## Safety Decals (continued)

<b>⚠ DANGER</b>		<b>⚠ PELIGRO</b>	
		<b>CHUCHILLAS ROTATIVAS</b> Para prevenir lesiones graves o de accidentes mortales causados por las cuchillas rotativas: •Manténganse a distancia estando funcionando las cuchillas o el motor. •No pongan las manos ni los pies debajo de la plataforma estando en marcha el motor.	
<b>ROTATING BLADES</b>		<b>⚠ DANGER</b>	
To prevent serious injury or death from rotating blades:  •Stay clear when blades are turning or engine is running. •Do not place hands or feet under deck when the engine is running.		<b>LAMES ROTATIVES</b> Prévenir les blessures graves et la mort que peuvent causer les lames rotatives: •Rester éloigné quand les lames tournent ou que le moteur tourne. •Il est interdit de mettre les mains ou les pieds sous le capot quand le moteur tourne.	
		<small>SD-005A</small>	

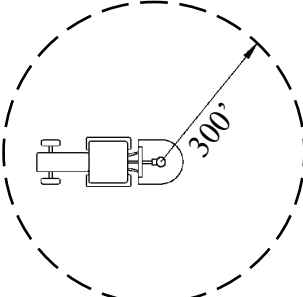

	<b>⚠ DANGER</b>
	Maintain safety distance of at least 300 feet. Failure to do so may cause serious injury or death.

**⚠ Danger**

Maintain safe distance.

The cutter creates a serious discharge hazard. Always maintain a safety distance of at least 300 ft.

**Never operate cutter with bystanders present!**



## Equipment Safety

### Safety Decals (All Models)

Safety decals must be positioned as illustrated below. Use this diagram to correctly identify missing, damaged, or illegible decals for replacement.

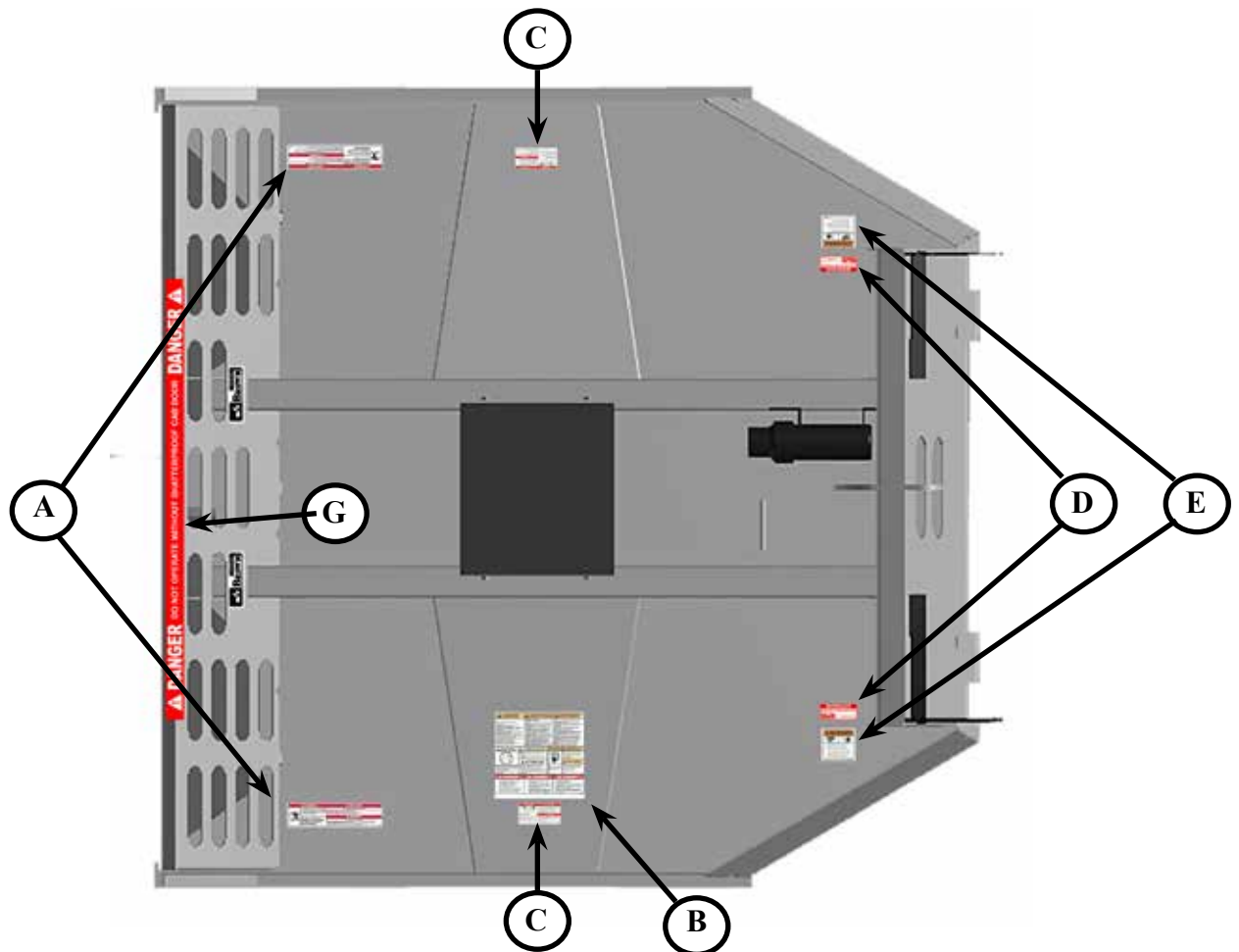

Ref. No.	Part No.	Qty.	Description
A	SD-001A	2	Safety Decal: Thrown object hazard
B	SDL-020	1	Safety Decal: Lexan Combo
C	SD-005A	2	Safety Decal: Danger Rotating blades
D	SD-020	2	Safety Decal: Tighten Fasteners
E	237-0002	2	Safety Decal: High Pressure Fluid Hazard
F	237-0020	2	Safety Decal: STAY BACK 300 FEET (Page 10)
G	237-SDW2	1	DANGER: DO NOT OPERATE WITHOUT SHATTERPROOF CAB DOOR

## Equipment Safety

### **Danger! Protect bystanders, clear work area of debris.**

Do not operate the cutter near people. Debris can be thrown hundreds of feet. Clear work area of foreign objects such as wire, glass, and other debris. Debris thrown by the cutter can cause serious injury or death.

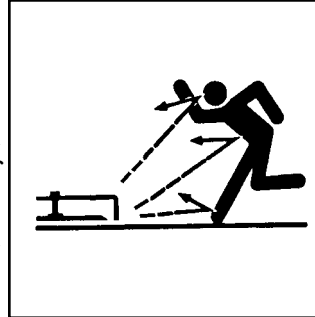

### **DANGER**

Do not operate cutter near bystanders. Clear work area of debris before operating.

### **Warning**

#### **Parking and dismounting.**

The rotating parts of this cutter continue to rotate even after power has been disengaged. The operator should remain seated until rotation has stopped. He should then set the brake, turn off the engine, and remove the key. See skid loader manual for proper parking procedure.

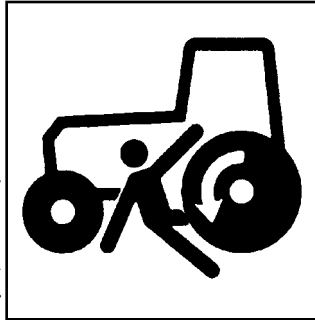

### **WARNING**

Wait for all rotation to stop before dismounting Skid Loader.

### **Caution**

#### **Avoid fires.**

Keep the machine clean of debris, trash, and any other flammable material..



### **CAUTION**

Keep machine clean of debris. Flammable debris on machine poses fire hazard.

### **Warning**

#### **Fasten Seat belt!**

Before Starting Skid Loader.  
Always Wear Your Seat Belt.



## Equipment Safety

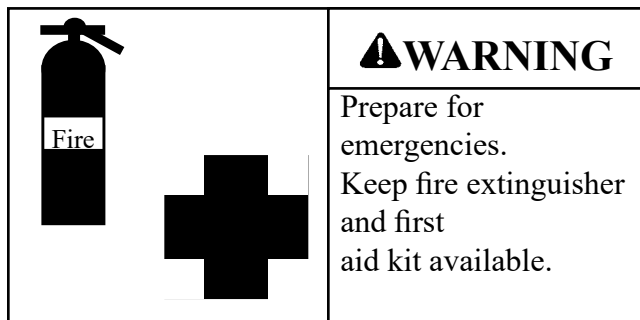

**⚠️ Warning**  
 Prepare for emergencies. Keep fire extinguisher and first aid kit available. Inspect fire extinguisher and check for charge daily. Check first aid kit for expired contents and keep stocked.

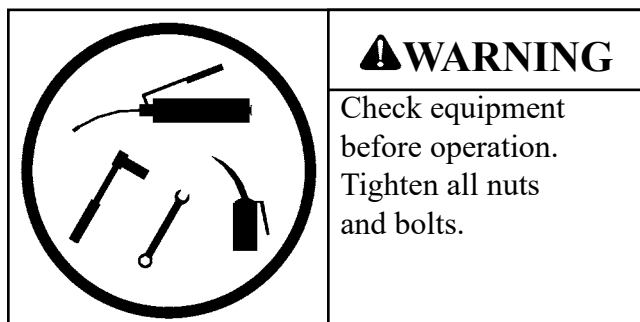

**⚠️ Warning**  
 Check equipment before operating. Tighten all nuts and bolts before operating. Make certain that equipment is lowered to ground before attempting to make adjustments or perform maintenance. Replace or repair any safety device, bolts, etc., if damaged or worn.

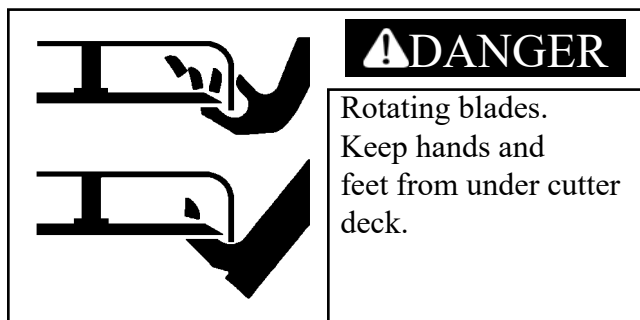

**⚠️ Danger**  
 Stay clear of rotating blades. The cutter is designed to cut woody material up to 6" in diameter. **Keep hands and feet from under cutter deck!**

## Equipment Safety

### Warning

#### **Wear protective clothing.**

Wear close-fitting clothing and other protective devices appropriate for the job.

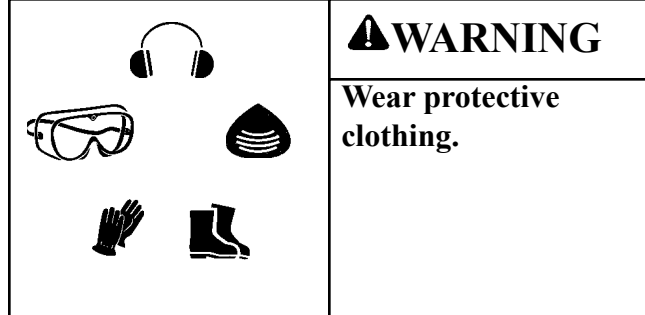

### Warning

#### **Roll-over protection.**

Operate cutter only on skid loader equipped with a certified rollover protective structure (ROPS).

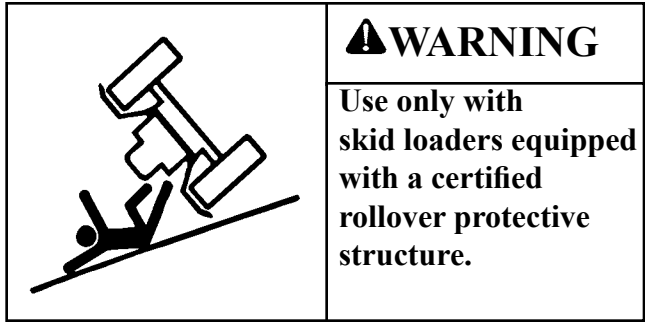

### Warning

#### **Slopes and rough terrain.**

When operating on slopes or rough terrain, decrease travel speed. Do not operate in an area where the skid loader could roll over. **Be sure to fasten safety belt when operating skid loader!**

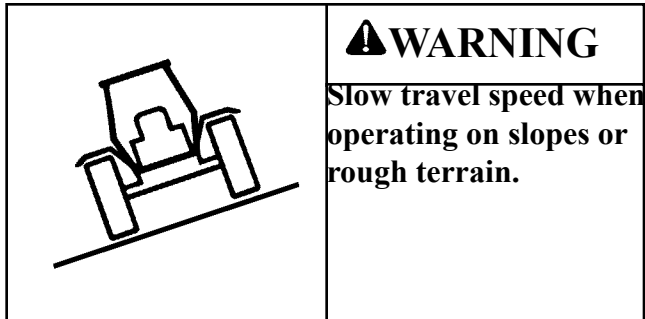

### Danger

#### **Tighten blade bolts.**

Blade bolts will stretch with use and **must** be tightened. Follow maintenance instructions in this manual (see Page 25). **If the cutter is operated with loose blade bolts, blades and blade carrier will be damaged. Operation with damaged blades and blade carrier will lead to blade ejection and will cause serious injury or death.**

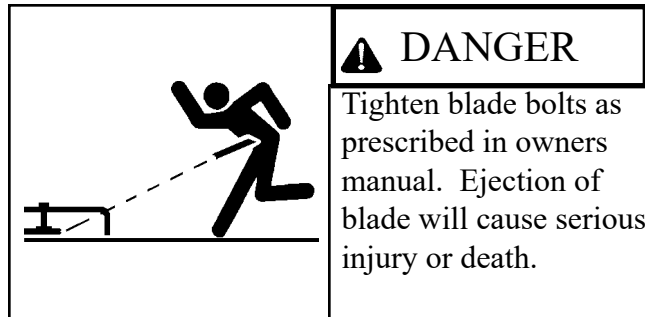

# Equipment Safety

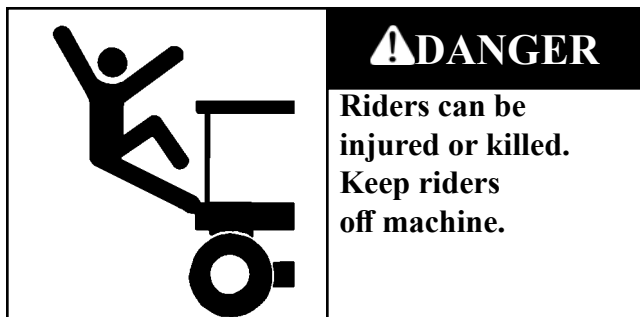

## ⚠️ Danger

Keep riders off machine.

Riders can be seriously injured or killed by entanglement or by falling.

**⚠️ DANGER DO NOT OPERATE WITHOUT SHATTERPROOF CAB DOOR DANGER ⚠️**

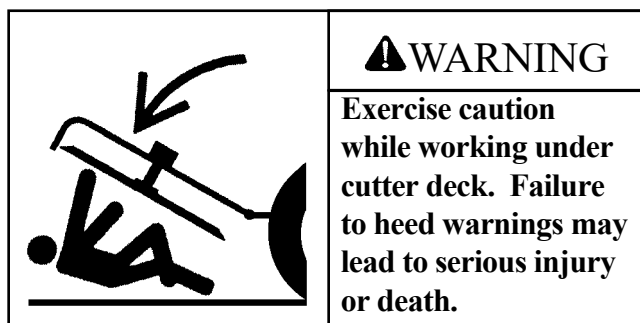

## ⚠️ Warning

Hazardous service conditions.

While working under the cutter deck, be aware of safety hazards. Follow safety precautions specified in this manual (see Page 26). Failure to exercise caution may lead to serious injury or death.



## ⚠️ Warning

High Pressure Fluid Hazard.

Hydraulic Brush Cutters have hydraulic motors and hoses, use all safety precautions when working around hydraulic components.

## Attaching Cutter/Hose Diagram

Before attaching cutter to your skid loader, make sure all safety devices are installed on both the cutter and the skid loader.



Please follow all safety instructions and procedures.

### Attach equipment to skid loader.

Be sure the skid loader is equipped with a certified roll-over protection structure (ROPS), and an enclosed operator-protective cage to prevent hazards such as thrown, falling, or stationary objects from entering the protective cage.

Be extremely careful when positioning skid loader to hitch to the equipment.



**Caution** Never allow anyone between the skid loader and the equipment during the attachment process.

Be certain that the cutter bearing housing has been lubricated properly and check oil level in bearing housing prior to connecting hydraulic hoses to skid loader.



**Warning** Improperly attached hydraulic lines can damage the motor, will disconnect and may cause personal injury or property damage. High pressure hose must be connected to Port "A".

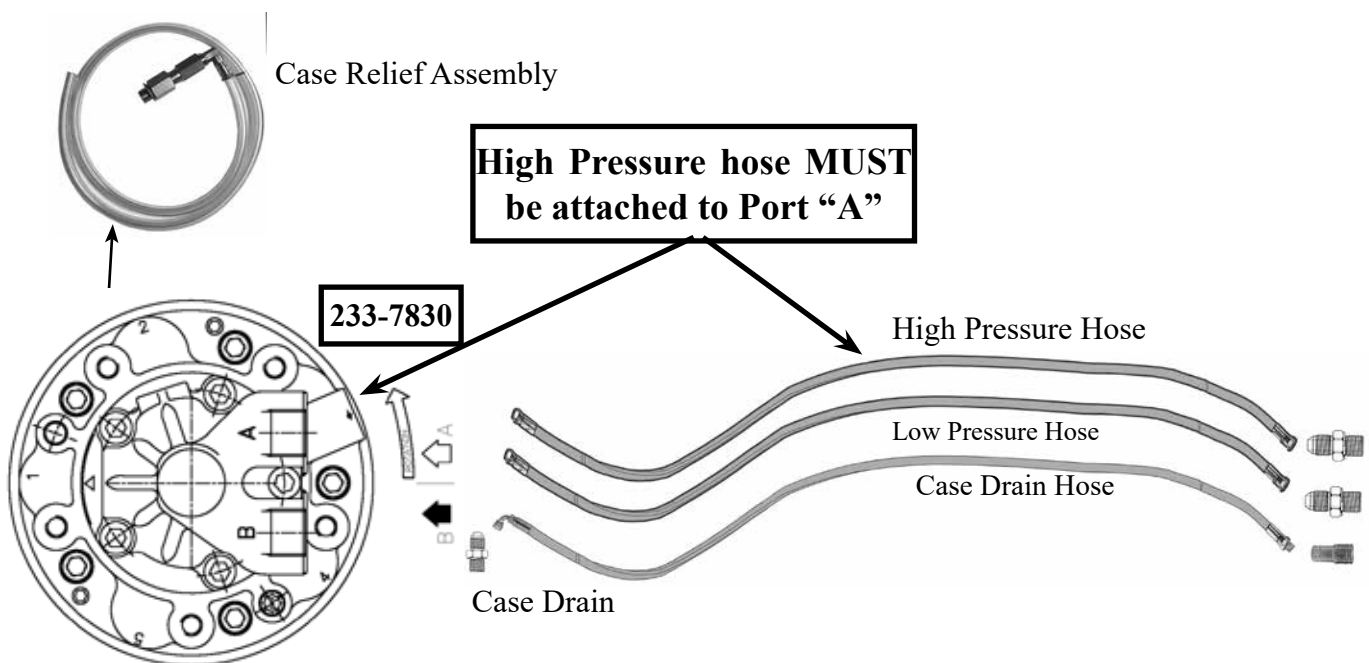



## Cutting Height

**Warning** Be certain that skid loader engine is stopped, key is removed, and all rotation of the cutter has ceased before making adjustments to choke chains.

**Caution** Avoid very low cutting heights. Striking the ground with blades can cause a damaging shock that can damage both the cutter and the skid loader.

Set the cutter to the desired height; the cutter is designed to operate with a cutting height range between 2" and 12". Note that, **on level ground, the front of the cutter should be 1" below the rear.**

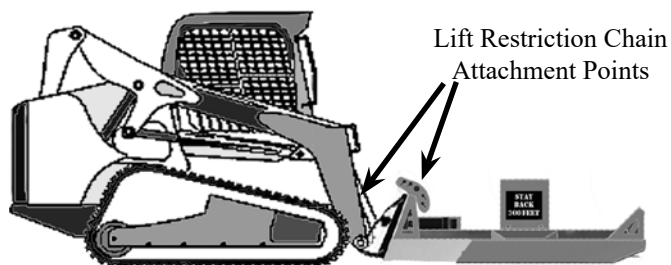
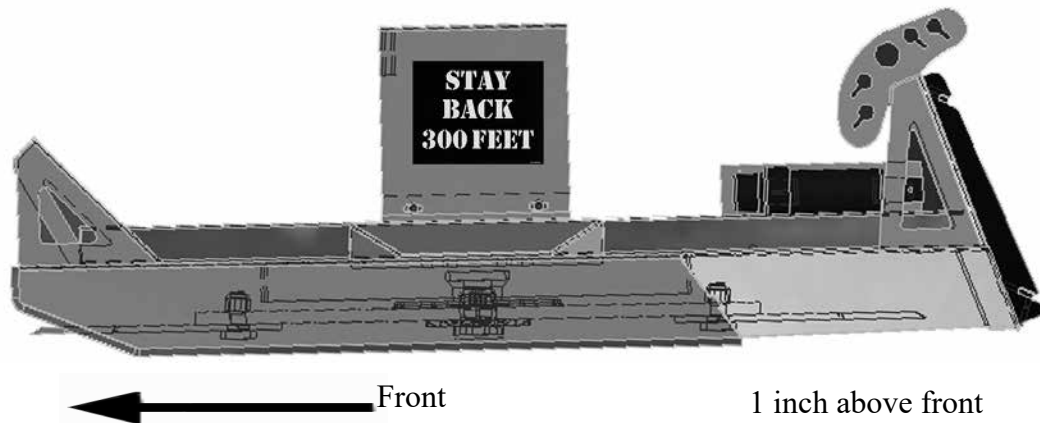

### Lift Restriction Chains

#### Using Lift Restriction Chains -

A lift restriction chain is a length of chain that attach from the skid loader frame to the attachment point on the cutter unit. The chain is intended to limit cutter height, insuring that the cutter remains **below** the operator's level, to keep debris from being discharged toward the operator.

A bracket attached to front of the skid loader's frame holds the center of the choke chain taut in slots milled to the width of a chain link. Choke chain length is adjustable by choosing which chain link is inserted into the retention slots of the bracket on top of the cutter; fine-tuning of the chain lengths may be performed by twisting the chains before securing the chains into their retention slots.

## Starting Cutter Operations

Before engaging your hydraulics, lift the cutter clear of the ground and any obstructions to ensure the blades are free to rotate. As you engage your hydraulics, your skid loader engine may try to stall or lug down. If this happens, disengage and reengage your hydraulics. This will give the blades time to begin turning. Allow the cutter to come to full speed before cutting.

After your Brush Cutter has reached operating speed you may notice a small amount of vibration, this is normal.

**!Notice:** If there is enough vibration to shake the unit in a violent manner, the unit should be shut down immediately. Refer to the troubleshooting guide of this manual or call the factory for help at 800.633.8909.

Your Brown Brush Cutter has been designed to cut anything that your properly rated skid loader can drive over (grass, brush, small trees up to about 6 inches in diameter). Any trees larger than this are too large for the Brush Cutter and should not be cut with this machine.



**Warning!** Trees can fall in any direction, it is the operator's responsibility to be sure the area is safe and clear.

**Refer to the warranty section of this manual for the warranty statement on use of the Brush Cutter.**

## Cutter Operation

Power for operating the cutter is supplied from the skid loader hydraulics. Refer to your skid loader manual for instructions on engaging and disengaging auxiliary hydraulics.



**Warning!** Operate cutter only within the specified RPM range.

### Operating speed

Proper ground speed for equipment will depend upon the height, density, and type of the material to be cut. Consult the skid loader owner's manual to determine the engine RPM to achieve the required cutter RPM. Engine RPM should not drop more than 300 RPM when cutting, if this happens slow down until the specified engine RPM is maintained. Dull blades will also require more power and result in lower ground speeds, always be sure blades are sharp.

The skid loader's ground speed when cutting into large diameter material is very important. If you cut a tree too fast, it will cause the trunk of the tree to kick straight back allowing the top of the tree to fall back toward the skid loader. The proper ground speed for cutting into the material is based on the size of the material. The slower the unit is driven into large diameter trees the more time the blades have to do their job.



**Caution!** During the time the blades are making contact with any material, **DO NOT** move the skid loader lift setting. The movement of the cutter deck will again increase the pressure on the blades. This pressure can and will cause blades to bend or break.

### General Operation

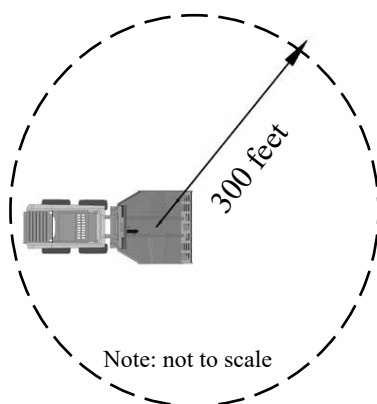

**Warning** The cutter creates a very serious discharge hazard. Maintain a safe distance from nearby persons and property. **Do not operate when bystanders are present.**



**Warning** Avoid personal injury. Remove all rocks and other debris from work area before cutting.

Observe the following guidelines when operating the cutter:

- Never lower the cutter onto material.
- Avoid tight turns near trees or stationary objects. The deck may be damaged by side impact.

**Remember:** The safe operation of this equipment is the responsibility of the operator. The operator should be familiar with both the skid loader and the equipment. The operator must read and understand all applicable operator manuals and follow all safety practices.

## Cutter Operation

When the Brush Cutter is cutting large diameter trees it is very important to keep the cutter deck level. If the cutter deck is not level, its ability to cut is greatly reduced. There is a tremendous amount of pressure being applied to the blades, when the blades are making contact with the tree on an elevated angle. The blades must be level in relationship to the ground. If not level the pressure can cause the blades to bend or break, possibly causing serious injury or death. (SEE DRAWING BELOW)

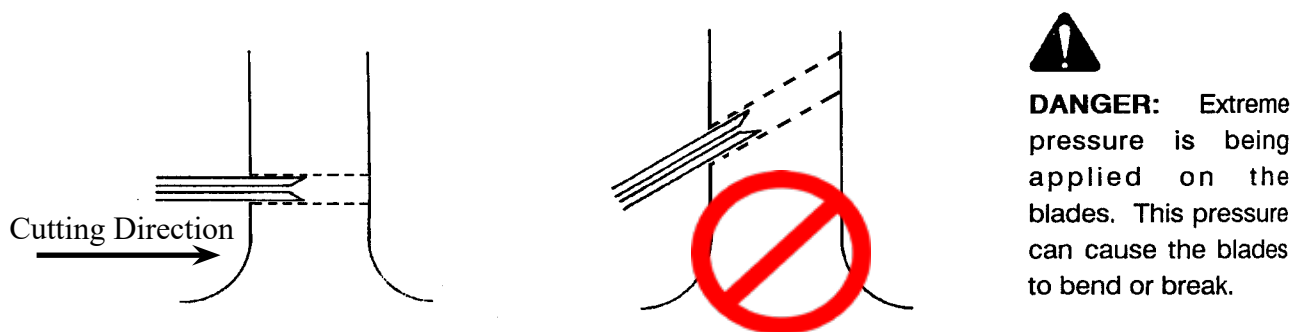

**DANGER:** Extreme pressure is being applied on the blades. This pressure can cause the blades to bend or break.



**Caution!** After the first hour of operation, the Brush Cutter must be shut down for maintenance and inspection. During this time ALL bolts must be checked for proper torque. If any bolts are found to be loose, they must be tightened. This is also a good time to check for wire or vines caught around to output shaft of the bearing housing. Check the blade and bolts and shaft for debris before **all** start ups.



### **Warning:**

**Discharge Hazard!** A safe distance from persons and property must be kept at all times during the operation of your brush cutter, regardless of the model or design. This distance is to protect persons and property from death, injury, or damage.

It is the sole responsibility of the operator to insure a safe operating area.

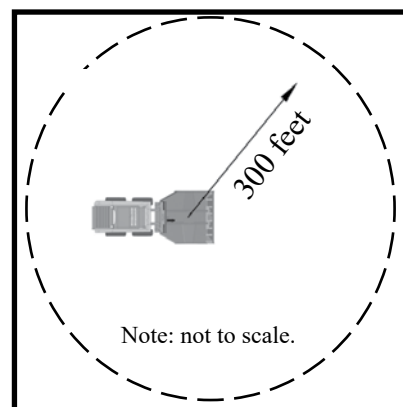

**CAUTION - NEVER OPERATE THIS UNIT WITHOUT PROPER SAFETY DEVICES IN PLACE - SERIOUS INJURY OR DEATH CAN OCCUR.**

## Operating Instructions

### THE TEN COMMANDMENTS OF OPERATION

1. **ALWAYS** - Read and understanding the owners manual before operating this or any other equipment.
2. **ALWAYS** – Attach this equipment to a skid loader that has suitable safety equipment properly installed.
3. **ALWAYS** – Operate this equipment with all safety devices properly installed on this equipment.
4. **ALWAYS** – Inspect, walk, flag or remove all foreign material from job site before starting the cutting process.
5. **NEVER** – Allow any riders or bystanders within 300 feet of this unit during operation.
6. **ALWAYS** – Check all bolts, fasteners, fittings and oil levels before beginning operations each day. Make sure all blades are free swinging.
7. **NEVER** – Allow blades to make contact with rocks or stumps – unit was not designed for this type of operation.
8. **NEVER** – Allow an untrained operator to operate this equipment.
9. **ALWAYS** – Install only genuine Brown replacement parts.
10. **ALWAYS** – Remain on skid loader seat until blades have stopped turning and all skid loader shut down procedures have been completed.

**THESE ARE ONLY A FEW OF THE SAFETY PROCEDURES THAT MUST BE FOLLOWED TO INSURE THE SAFE OPERATION OF THIS EQUIPMENT – MANY OTHER SAFETY RELATED POINTS ARE STATED THROUGHOUT THIS MANUAL**



**WARNING: FAILURE TO FOLLOW THE TEN COMMANDMENTS CAN AND WILL CAUSE SERIOUS INJURY OR DEATH**

**IF YOU HAVE ANY SAFETY, MAINTENANCE OR OPERATIONAL QUESTIONS – PLEASE CALL THE FACTORY BEFORE USING THIS EQUIPMENT – 1-800-633-8909**

# OPERATING INSTRUCTIONS



## Warning:

**NEVER ALLOW BLADES TO COME INTO CONTACT WITH ROCKS OR STUMPS.**

The blades will glance over the obstruction, causing upwards pressure on the blades, blade bar and output shaft. This pressure can and will cause fatigue, cracking and possible breakage of the components. NEVER lower blades down onto material, the same pressures will be applied to the components causing failure.

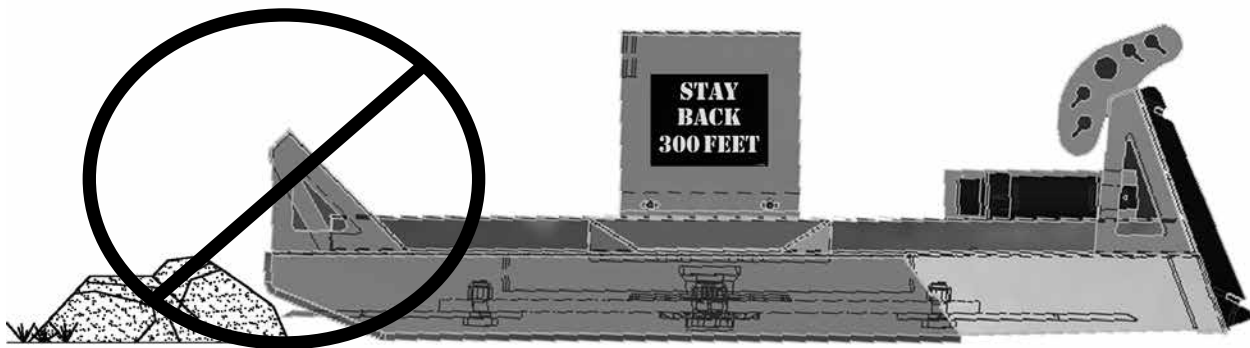

**WARNING! NEVER DO THIS!**

# OPERATING INSTRUCTIONS

PLEASE READ AND UNDERSTAND  
IF YOU DO NOT UNDERSTAND ANY POINT STATED BELOW  
YOU MUST CALL THE FACTORY FOR ASSISTANCE  
1-800-633-8909

**USE ONLY GENUINE BROWN REPLACEMENT PARTS.**

**USE OF AFTERMARKET PARTS OR COMPONENTS WILL VOID ANY WARRANTY CONSIDERATION**

- BLADES** This machine was designed to operate **ONLY** with sharp blades. Dull blades will cause multiple types of problems that are **NOT** covered under warranty:
- a. Overheated hydraulic system
  - b. Extreme wear on blade bolts
  - c. Blade bar fatigue and cracking or total failure
  - d. Blade fatigue and cracking or total failure
  - e. Deck fatigue and cracking
  - f. Increased amount of discharge or debris
  - g. Poor cut – increased amount of uncut material
  - h. Blades must be freely pivoting during operation
- BLADE BOLTS** Blade bolts **MUST** be kept tight and checked twice daily during operation. Every hour for the first 8 hours of use.
- a. Brown blade bolts are designed for extreme conditions and should not be substituted for any reason.
  - b. 6' Brush Cutter blade bolts are **RIGHT** hand thread
  - c. Bolts and lock nuts are matched as pairs or sets – do not mix
  - d. See maintenance section for proper torque specifications
- BLADE BAR** Proper maintenance of blade bar will insure long life.
- a. Loose blade bolts will impact the bottom of the blade bar, causing the blades to lock into a fixed position.
  - b. Loose bolts will cause the elongation of bolt holes
  - c. Dull blades will cause the blade bar to crack and fail
  - d. Blade bar nut must be checked and kept tight at all times
  - e. Loose blade bar can cause output shaft failure, blades striking the bottom of the deck, blade breakage and blade bar cracking
  - f. Blade bar **MUST** be inspected daily for cracking or fatigue
  - g. Use threadlocker when installing/reinstalling blade bar.

# Hydraulic Plumbing

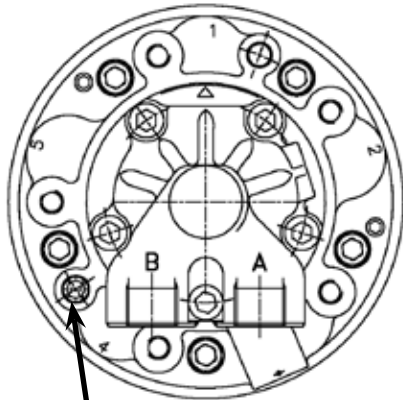

233-7830

233-9002-06-04



233-232-8015

233-232-8030

**High Pressure Hose *MUST* be attached to Port "A"**

High Pressure

233-3HTOF4



233-6400-16-12

Part Number	233-232-8400 Hydraulic Hose Pack	Qty
233-6400-16-12	1" JIC Male x #12 SAE/ORB Male	2
233-9002-06-04	FITTING, HYD, w/ORING, WASHER 3/8" JIC Male x 1/4" BSPP Male	1
233-232-8015	#6 FJX90-100"OAL-#8MBX Sleeved 3000psi	1
233-3HTOF4	3/8" Female Coupler, #8 SAE/OR Flat Face Coupler	1
233-232-8030	#16MB -100"OAL-#16FJX Sleeved 5000psi	2



# Maintenance

## Daily Maintenance

1. Repeat all steps listed under the “Initial Maintenance” section (next page) on a daily basis after the initial maintenance has been performed.
2. Check and maintain the proper amount of lubricant in the bearing housing, oil weight is 85-140, our part number is T5-LUBE (see page 35).
3. Check blades; sharpen or replace as necessary. **When sharpening blades, only sharpen the beveled edge. Also, be certain that paired blades weigh within one tenth of a pound of each other. When replacing blades, replace both blades of the pair.**

 **Warning!** If the blades must be sharpened, follow the proper safety procedures listed on page 32 of this manual for working under the cutter deck.

## Tightening Blade Bolts

Before starting a cutter, or after blades have been removed for any reason, tighten blade bolts using the following procedures. **Repeat hourly inspections each time the blades are removed/replaced.**

 **Warning!** Follow safety guidelines listed on Page 26 of this manual when working under cutter deck. Do not rely on the skid loader’s lift arms to support the cutter while performing maintenance.

1. Disengage Hydraulic power; be certain that all rotation has stopped.
2. Lift cutter high enough to place suitable supports under the cutter deck.
3. Turn skid loader engine off; remove key; lock transmission and brakes; chock wheels or tracks.
4. On Brown 826 Model, Use a suitable wrench to hold the blade bolt head; torque blade bolt nut with a 2 3/4” socket, to approximately 1200 to 1500 ft./lbs.
5. If your blade is NOT free swinging after tightening blade bolts, disassemble immediately and install a shim on shoulder of blade bolt, shims are listed on Page 42, the shims used depend on model. Do NOT operate a unit with blades that are not free swinging.

## Maintenance

### Safety When Working Under Cutter Deck

Never work under the cutter deck until:

- the cutter is sufficiently braced and supported
- the skid loader engine is off, brake is set, and key is removed
- Hydraulics have been disengaged
- Hydraulic hoses disconnected
- skid loader tires or tracks have been secured with tire chocks
- the cutter is at ambient temperature



**Warning!** Failure to follow these safety guidelines can result in serious injury or death.

### Initial Maintenance



**Warning!** These maintenance practices must be followed every hour for the first eight hours of operation; the practices must also be performed every hour for the first eight hours following the removal/replacement of any of the components named in this section. Check daily thereafter.

1. Check for debris deposited between the blade bar and the blades. Debris found jamming or locking the blades must be removed to insure that the blade may pivot freely on the blade bolt.



**Warning!** Failure to maintain freely pivoting blades can cause severe vibration or blade breakage which can result in injury or death.

2. Tighten blade bolts, see Page 25 for blade bolt tightening instructions, and for blade bar installation instructions, see Page 32.



**Warning!** Failure to tighten blade bolts and blade bar nut can cause blade bolts, blades, or output shafts to break, which can result in injury or death.

3. Check and remove any debris deposited around the output shaft.

4. Tighten bearing housing mounting bolts.

**Caution!** Failure to keep the bearing housing bolts tightened can cause the blades to strike the bottom of the cutter deck, break the output shaft of the bearing housing, or break the bearing housing case.



**Warning!** If blade bolts are allowed to run loose, the obvious danger is for the bolt to come completely loose, allowing the blade, bolt, and nut to be ejected from the cutter.

## Maintenance

### Tightening Blade Bolts (*continued*)

**!** The second danger is, when the bolt is not sufficiently tight, the blade is allowed excess vertical movement when it strikes an object, be it something it will cut or something into which it should not come in contact. In this situation, the blade is being hammered against the blade carrier and flexed, or bent, up around the edge of the blade carrier at least twelve (12) times per second, generally fifteen (15) times per second. This situation will cause the blade to break from fatigue and to be ejected from the cutter.

**!** The third danger is that, while the second situation is occurring, the blade bolt is also hammering the underside of the blade carrier; the shoulder of the blade bolt beats an indentation around the blade bolt hole into which the bolt shoulder will fit. When this damage occurs, the blade bolt will pull up into the indentation when the bolt is tightened, causing the blade to jam so that it can no longer pivot on the blade bolt. A jammed blade will break either from fatigue or from catastrophic occurrence and will allow the blade to be ejected. A blade carrier damaged in this manner must be taken out of service immediately. Repair the blade carrier (contact Brown Mfg. Corp. for instructions) and replace the blades and blade bolts before returning the machine to service.

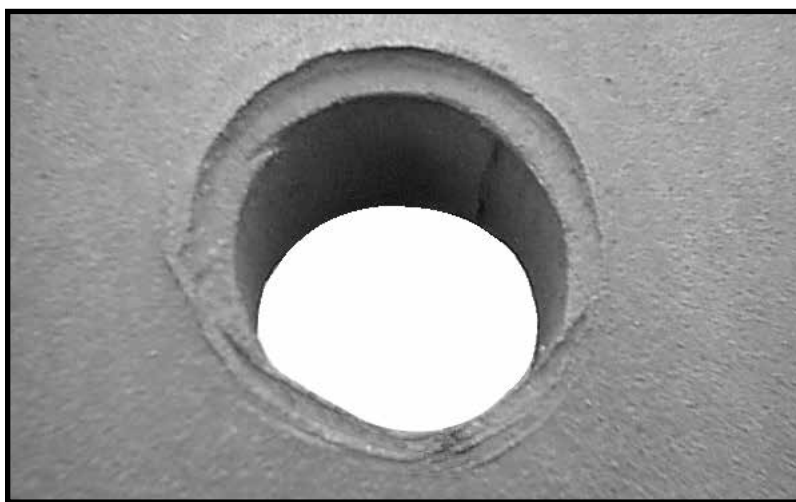

**!** All three of the described occurrences will cause the blades to break and be ejected. An ejected blade can and will cause serious injury or death.

**REMEMBER: Blades must pivot freely and blade bolts must be tight!  
Shims are available if your blades bind when bolts are tight, see Page 42 for part number of shims.**

## Notes

# Maintenance

## Sharpening Blades

### Blade sharpening procedure:

The Brush Cutter blades are manufactured from Ultra-Kor™ alloy, a high strength alloy. When sharpening this blade material using a side grinder, use extreme caution not to over heat the material. Allowing the grinder to stop or rest in one spot will cause the material to turn “blue”. Avoid over heating by keeping the grinder moving at all times. The first 1” to 1 1/2” of the blade and the blade tip is where most of the cutting action takes place. This is point of contact and the blade bevel must be maintained and kept sharp. If you have the skill to sharpen the blades with a torch, less heat will be transmitted into the material and will have longer blade life if sharpened in this manner. Always remove equal amount of blade material from the paired blades. Blades must be kept within 1/10 of a pound of each other. Always keep blades in the same pairs, (blades across from each other, as removed from the cutter.

**NOTE: Failure to keep the blades sharp will cause multiple problems, including**

1. Hydraulic oil overheating.
2. Extreme blade bolt wear
3. Blade bar fatigue, cracking and total failure
4. Blade fatigue, cracking and total failure
5. Deck fatigue and cracking
6. Increased amount of discharge or debris
7. Poor cut – increased amount of uncut material

Food for Thought: If your blade was an axe head, would you try to cut a tree with it?

### Proper Bearing Housing Lubrication

With the cutter sitting level, clean and remove the plug from the top of the bearing housing. Wipe the plug clean. Add oil. Proper replacement oil is 85-140 weight gear oil, our part number is T5-LUBE. Make certain the plug is replaced and tightened securely before operating. If the oil is low , the lower seal should be inspected at once.

## Blade Installation

**DO NOT RELY ON THE SKID STEER LIFT SYSTEM TO HOLD THE CUTTER UP DURING ANY MAINTENANCE PROCEDURE.**

Shut the unit down, see page 32 for “Safety When Working Under Cutter Deck”. Lift the cutter deck about one foot above the ground and place jack stands or blocks on each side of the cutter deck to support the weight of the cutter. Lower the deck to rest on the stands.

The Brush Cutter uses a total of four cutting blades, all blades are in weighed pairs. It is necessary that the blades are installed in the correct sequence. When installing new blades, alternate the position of the cutting bevel, first one blade up, next blade bevel down. After all four blades are installed, bevel up blades will be directly across (180 degrees) the blade bar from each other.

Replacement blades are shipped in pairs by weight, keep blades in pairs - DO NOT MIX - mount pairs across the bar from each other.

All blades are mounted underneath the blade bar, the blade bolt is inserted from below with the nut on top of the blade bar.

NOTE: See blade bolt tightening procedure for additional information on blade bolt torque requirements. See Page 31 for tightening instructions.

**NOTICE: IF FOR ANY REASON ONE BLADE MUST BE REPLACED, ITS OPPOSING BLADE MUST BE REPLACED AT THE SAME TIME TO INSURE PROPER BALANCE OF THE BLADE BAR. IMPROPER BALANCE OF THE BLADE BAR WILL CAUSE VIBRATION AND POSSIBLE COMPONENT FAILURE.**

Diagram denotes proper blade placement.

**Blades are sold in pairs only, by weight - mount in pairs only!**

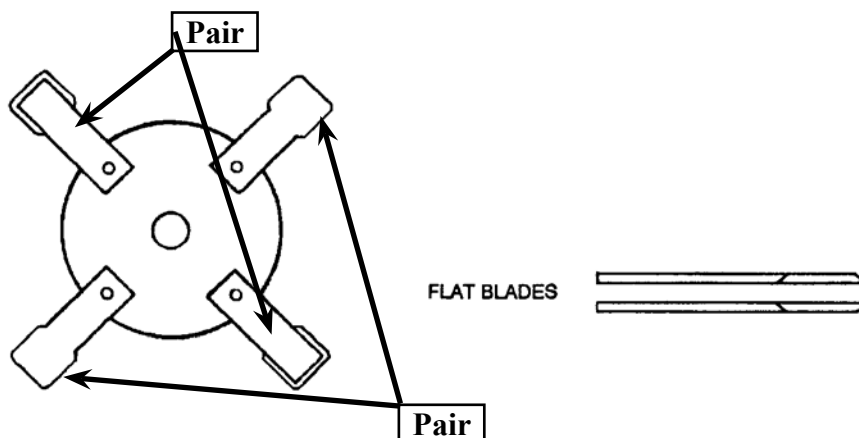

## Blade Bar Removal Technique

**! CAUTION! KEEP FINGERS, HANDS, AND FEET OUT FROM UNDER THE CUTTER BAR AT ALL TIMES. FALLING BLADE BAR CAN CAUSE INJURY.**



**CUTTER DECK MUST BE SUPPORTED BY WHATEVER MEANS NECESSARY TO PREVENT DECK FROM FALLING WHILE IN THE HORIZONTAL POSITION. FAILURE TO SUPPORT THE DECK CAN AND WILL CAUSE DEATH OR SERIOUS INJURY.**

**Step 1. Remove the blades from the blade bar.**

**Step 2. With the cutter deck safely supported in an upside down horizontal position, using a forklift or forklift attachment with the forklift blades 34.5” apart, place the blades below the blade bar, as shown is Fig 31.1.**

**Step 3. Remove the 8 bolts from the blade bar cover with a 3/4” 12 point impact socket.**

**Step 4. Slowly take up any remaining slack on the lifting forks and wiggle the blade bar until it is clear of the flanged shaft.**

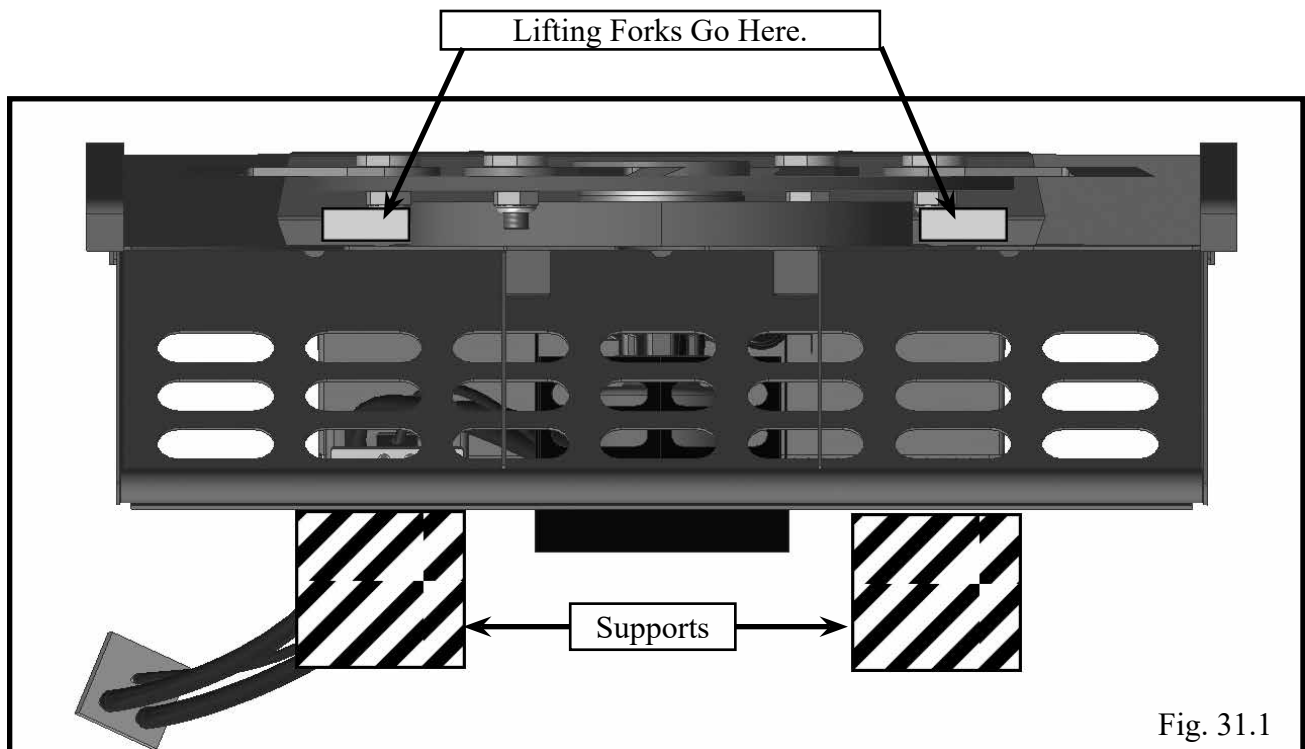

Fig. 31.1

# Blade Bar Installation Procedure

## *BROWN 800 Series Brush Cutter*

### BLADE BAR INSTALLATION

**NOTE:** Prior to blade bar installation, ensure that the flanged output shaft is clean and dry.

**Step 1 -** Remove or secure hydraulic lines so the cutter can be turned upside down.

**Step 2 -** Using a suitable lift, turn the cutter upside down, being careful not to damage the bearing housing and motor. The cutter should rest on the front and rear headers, use blocking if necessary.

**Step 3 -** Be sure that the flanged output shaft is clean. Align the blade bar with the holes in the flanged output shaft. Lower blade bar onto flanged output shaft and install cover plate. Using a starter stud will help align the holes in the OHLA (Over Hung Load Adapter).

**Step 4 -** Install 8 - 3/4" - 12 point flange bolts with thread locker, Part No. 255-42810, through cover plate and blade bar. Finger tighten all bolts. Check the mounting surfaces to ensure proper fit.

**Step 5 -** Tighten all bolts to 280 ft/lbs. torque using the 8 bolt torque pattern Fig. 32-1.

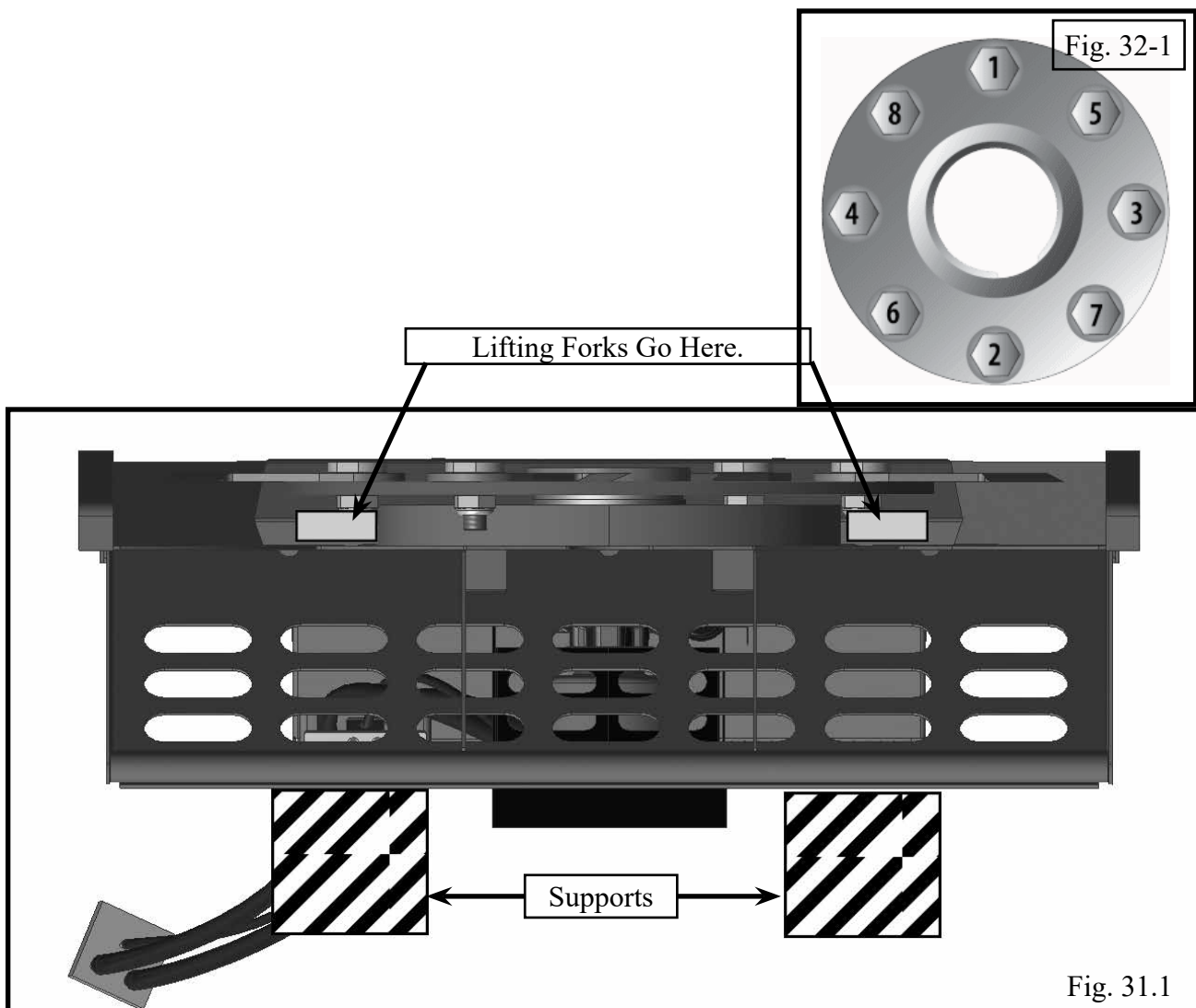

Fig. 31.1



## BLADE BAR TIGHTENING PROCEDURE FOR ALL BROWN BRUSH CUTTERS

On first start up of a brush cutter, or after the blade bar has been removed for any reason, the following steps must be followed:

### **AFTER THE FIRST HOUR OF OPERATION:**

Shut the unit down, lift the cutter deck approximately two feet above the ground. Place jack stands or blocks under the blade bar. Then lower the cutter onto the stands to support the entire unit's weight on the blade bar allowing the output shaft to seat as deep as possible into the hub of the blade bar. (See diagram), do not rely on the skid loader's lift system to hold the cutter up during any maintenance procedure.

Using a 6 point socket and appropriate torque wrench, tighten the blade bolts to 1200 to 1500 ft lbs. torque.

THE BLADE BAR SHOULD BE CHECKED DAILY BY INSERTING A LONG PRY BAR BETWEEN THE DECK FRAME AND BLADE BAR. USING A PRYING MOTION, VISUALLY CHECK FOR ANY LOOSE VERTICAL MOTION. IF ANY LOOSE MOTION IS DETECTED, FOLLOW THE BLADE BAR TIGHTENING PROCEDURE. IF THE BLADE BAR WILL NOT REMAIN TIGHT, DISASSEMBLE THE UNIT AND CHECK THE SHAFT AND BEARINGS FOR WEAR. REPLACE AS NECESSARY.





## Troubleshooting

Problem	Possible Cause(s)	Possible Solution(s)
Excessive vibration	<ol style="list-style-type: none"> <li>1. Loose bearing housing bolts</li> <li>2. Loose blade bar and/or blade bolts</li> <li>3. Blades are not freely swinging</li> <li>4. Broken, bent, or warped blades</li> <li>5. Blade bar not seated properly on shaft</li> </ol>	<ol style="list-style-type: none"> <li>1. Tighten bolts</li> <li>2. Tighten blade bar nut or blade bolt nuts</li> <li>3. Clear blade of obstruction, shim blade if binding.</li> <li>4. Replace set of blades and bolts, install shim between blade bar and bolt.</li> <li>5. Remove blade bar; clean shaft; reseal, torque nuts</li> </ol>
Overheating bearing housing	<ol style="list-style-type: none"> <li>1. Insufficient lubricant level</li> <li>2. Improper lubricant</li> <li>3. Debris build-up around bearing housing</li> <li>4. Bearings seated improperly</li> </ol>	<ol style="list-style-type: none"> <li>1. Fill to full level</li> <li>2. Replace with correct lubricant</li> <li>3. Remove debris</li> <li>4. Consult dealer</li> </ol>
Noisy bearing housing	<ol style="list-style-type: none"> <li>1. Failed bearing</li> <li>2. Worn bearing</li> </ol>	<ol style="list-style-type: none"> <li>1. Replace bearings immediately</li> <li>2. Replace bearings immediately</li> </ol>
Leaking bearing housing	<ol style="list-style-type: none"> <li>1. Damaged oil seal</li> <li>2. Bent shaft</li> <li>3. Oil seal installed incorrectly</li> <li>4. Oil level too high</li> <li>5. Shaft worn in oil seal area</li> <li>6. Shaft bore worn in casting</li> <li>7. Damaged gasket seat</li> <li>8. Loose bolts</li> </ol>	<ol style="list-style-type: none"> <li>1. Replace seal</li> <li>2. Replace seal and shaft</li> <li>3. Replace seal</li> <li>4. Drain oil to proper level</li> <li>5. Replace shaft</li> <li>6. Replace casting or gearbox</li> <li>7. Replace silicone gasket</li> <li>8. Tighten bolts.</li> </ol>
Short blade life	<ol style="list-style-type: none"> <li>1. Cutting too low</li> <li>2. Cutting in sandy or rocky conditions</li> <li>3. Inadequate blades</li> </ol>	<ol style="list-style-type: none"> <li>1. Increase cutting height</li> <li>2. Increase cutting height</li> <li>3. Replace with Brown OEM blades</li> </ol>
Not cutting clean	<ol style="list-style-type: none"> <li>1. Dull blades</li> <li>2. Insufficient hydraulic flow</li> <li>3. Cutter deck not level</li> <li>4. Ground speed too fast</li> <li>5. Blades not freely swinging</li> </ol>	<ol style="list-style-type: none"> <li>1. Sharpen or replace blades</li> <li>2. Ensure couplers are attached firmly</li> <li>3. Adjust cutter deck</li> <li>4. Reduce ground speed</li> <li>5. Clear blades of obstruction</li> </ol>
Hydraulic Oil Leaking on Deck.	<ol style="list-style-type: none"> <li>1. Oil in Relief Valve Tubing. Case Drain is Blocked.</li> </ol>	<ol style="list-style-type: none"> <li>1. Check hose for damage or blockage. Inspect Couplers for damage. Contact your skid steer dealer, case drain is not operational.</li> </ol>

**NOTE: Most common problems are caused by DULL BLADES!**  
**Continued use of this equipment with dull blades will shorten the life of the unit.**

## Specifications

<b>Model</b>	<b>Brown 815-2</b>	<b>Brown 825-2</b>	<b>Brown 816-2</b>	<b>Brown 826-2</b>
<b>Blade Tip Speed</b>	1000 RPM	1000 RPM	1000 RPM	1000 RPM
<b>Cutting Width</b>	60"	60"	72"	72"
<b>Bearing Housing</b>	120 HP	120 HP	120 HP	120 HP
<b>Deck Const.</b>	3/16"	3/16"	1/4"	1/4"
<b>Deck Width</b>	69"	69"	81"	81"
<b>Weight</b>	1,700 lbs	1800 lbs.	2,200 lbs	2,500 lbs
<b>Material Size</b>	6" max	6" max	6" max	6" max
<b>Bearing Housing Oil Capacity in Pints</b>	4.5	4.5	4.5	4.5

# Replacement Parts

## Deck Assembly - All Models

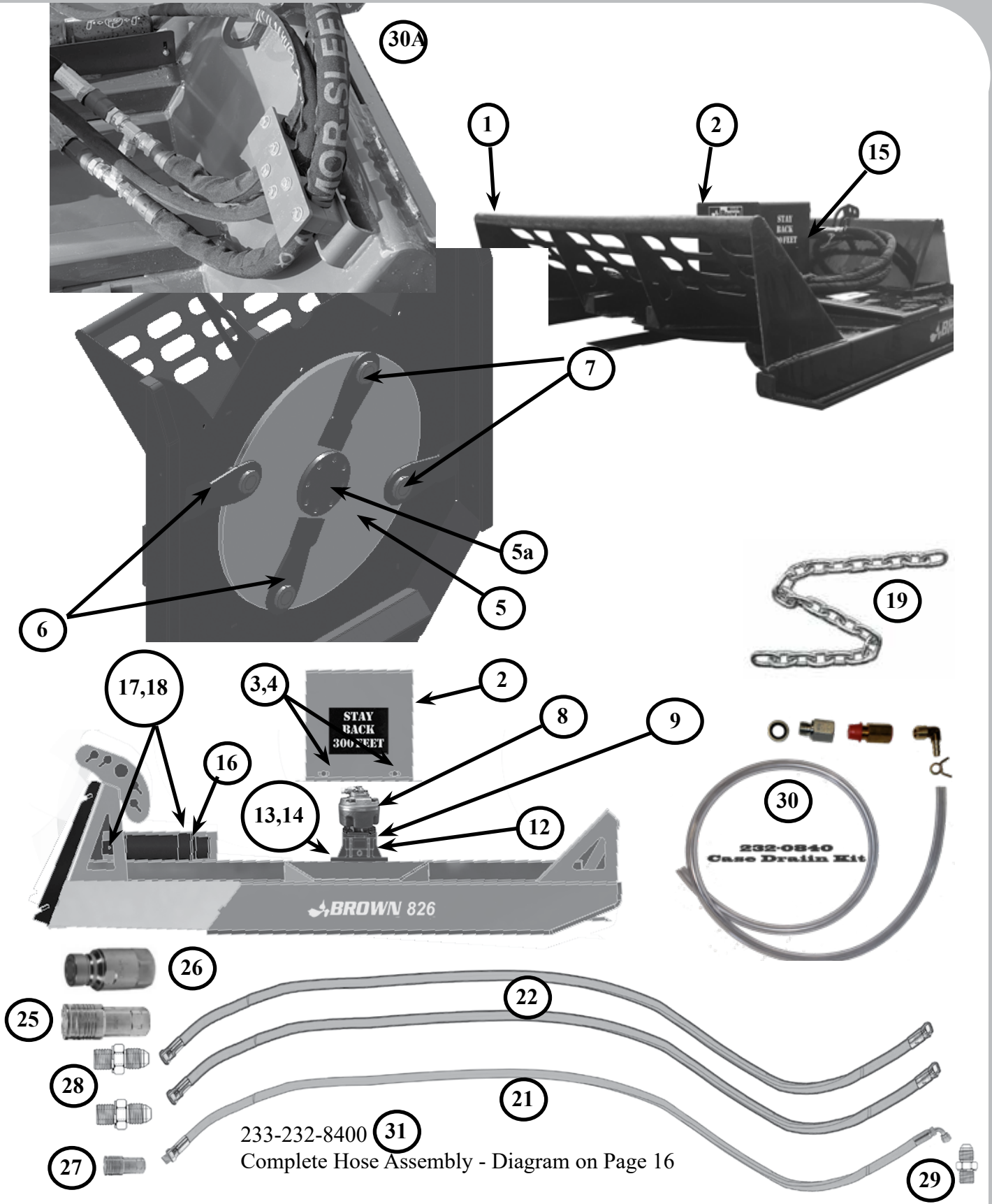

233-232-8400 **31**  
Complete Hose Assembly - Diagram on Page 16

## Replacement Parts

### Deck Assembly - All Models (continued)

Ref. No.	Part No.	Qty	Description
1	232-8205	1	6 Foot Deck Weldment
2	232-8120	1	Hydraulic Drive Guard
3	HC58C24Z	4	Bolt 1/2"-13 x 1 1/2" Grade 5 Zinc)
4	WSA50Z	4	Flat Washer SAE 1/2" Grade 5
5	232-2826	1	Blade Bar, Bolt-On
5a	232-8115	1	Bolt On Bar Cover
6	UK-165NB	4	Blades Priced each, sold in pairs only
7	T5-165NB	4	Bolt Kits - Sold in Sets Only
8	233-7830	1	Hydraulic Motor w Cross Ports
9	HCF88C20Z	4	Bolt, Flanged 1/2"-13 x 1 1/4" Grade 8 Zinc (Motor to Bearing Housing)
12	235-8100	1	Bearing Housing (under guard) see <b>page 42 for details</b>
13	HCF810F40Z	8	Bolt, Flange 5/8"-18 x 2 1/2" OHLA to Deck
14	NSF58FZ	8	Flange Nut 5/8" -18 OHLA to Deck
15	233-232-8400	1	High Flow Hose Package Series 2
16	MH-01	1	Manual Tube Holder/ Serial Plate Mount
17	CB5516C12Z	2	Carriage Bolt 5/16 -18 x 3/4 Grade 5 Zinc (For MH-01)
18	NNE516CZ	2	Nylon Lock Nut 5/16-18 Zinc For (MH-01)
19	232-8567	6 ft.	Lift Restriction Chain (See Page 20 for Installation)
21	233-232-8015	1	#6 FJX90-100"OAL-#8MBX Sleeved Hydraulic Hose
22	233-232-8030	2	#16MB -100"OAL-#16FJX Sleeved 5000psi
25	233-6HTOF6	1	3/4" Female Coupler #12 SAE Flat Face Coupler ORB
26	233-HT6OF6	1	3/4" Male Nipple #12 SAE Flat Face Coupler
27	233-3HTOF4	1	3/8" Female Coupler, #8 Flat Face Coupler
28	233-6400-16-12	2	1" JIC Male x #12 SAE/ORB Male Adapter (Coupler End)
29	233-9002-06-04	1	3/8" JIC Male x 1/4" BSPP Male ( Motor End Case Drain
30	232-0840	1	Case Relief Valve Kit
30A	700-232-8315	1	Hose Holder Top Plate
30A	700-232-8310	2	Block Spacer for Case Drain Hose
30A	233-H5027C	2	Hydraulic Hose Clamp Poly 1.66 Pressure and Return Hoses
30A	233-H4012C	1	Hydraulic Hose Clamp Poly 0.75 Case Drain Hose
31	233-232-8400	1	Hydraulic Hose Package

# Replacement Parts

## MOTOR/OHLA

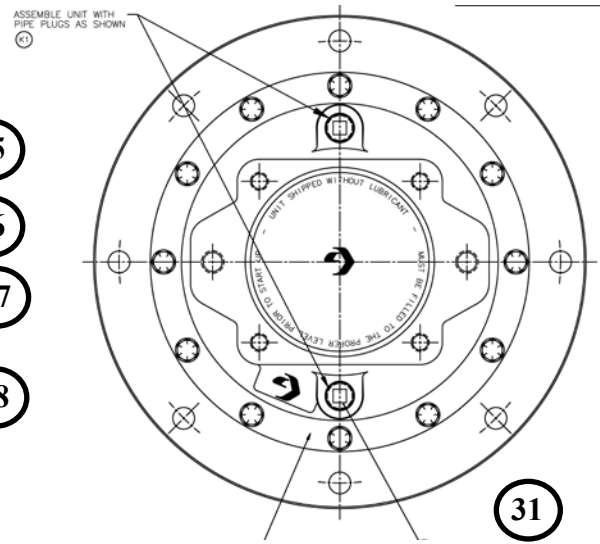
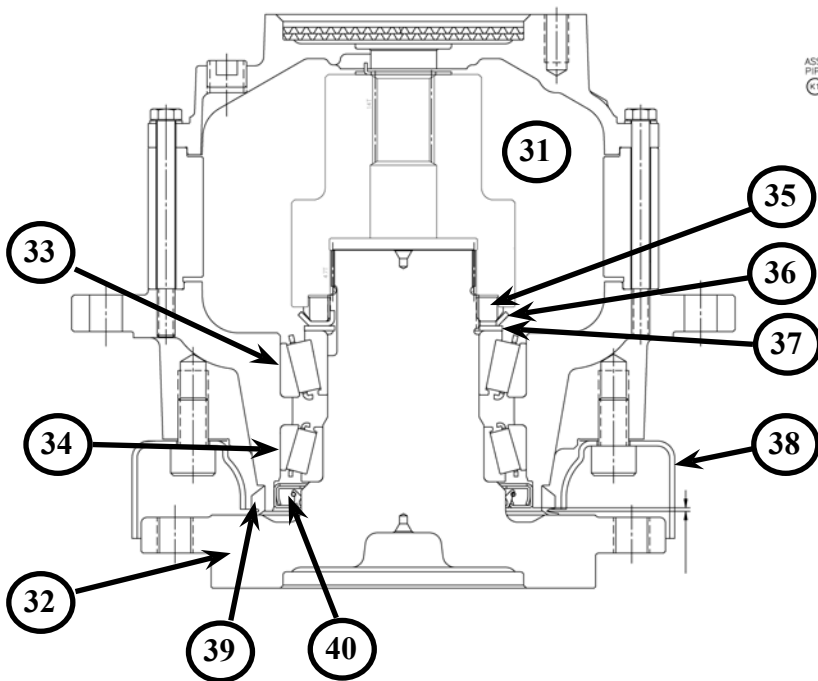
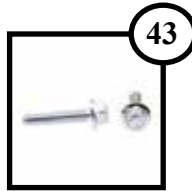



## Replacement Parts

### Motor/Bearing Housing(continued)

Ref. No.	Part No.	Qty	Description
30	233-7830	1	Hydraulic Motor w Cross Port
30a	233-8420	1	Stub Output Shaft
30b	233-8425	1	Shaft Retaining Ring
31	235-8100	1	OHLA Complete
32	235-8101	1	Flanged Shaft
33	235-8110	1	Bearing, Cup and Cone
34	235-8105	1	Bearing, Cup and Cone
35	235-8115	1	Lock Nut
36	235-8120	1	Lock Washer
37	235-8125	1	Thrust Washer
38	235-8130	1	Guard
39	235-8135	1	Seal-V Ring
40	235-8140	1	Oil Seal
41	HCF810F40Z	8	Bolt, Flange 5/8"-18 x 2 1/2" OHLA to Deck
42	NSF58FZ	8	Flange Nut 5/8" -18 OHLA to Deck
43	HCF88C20Z	4	Bolt, Flange 1/2 -13 x 1 1/4" - Hyd Motor to OHLA

START UP - Installation of new or rebuilt bearing housing, Item 31:

Place bearing housing on level surface, fill housing with approximately 2.25 quarts of T5-LUBE, 85-140 weight oil. Settling will occur, especially in cold weather. Put a small bead of RTV sealant around the **inside** perimeter of the top bearing housing mating flange, place the motor on top of the bearing housing and install and torque bolts to 52 ft/lbs. Bolts are listed as item 9 on Page 39. Install this unit with motor hydraulic ports facing the **rear** of the machine.

START UP - Installation of new motor, Item 30:

Before connecting any hydraulic lines ensure that they are clean, any contaminants should be removed. Connect high pressure hose to port "A" of motor, return hose to port "B". See page 24 for more information. There should not be any oxidation of surfaces that come into contact with the oil. Make sure the motor casing is filled with oil, add oil until full through the case drain. Before starting work, the hydraulic circuit should be purged of air. This can be achieved by running the motor without load for 10-20 minutes, during which time, watch for oil leaks. During the first few hours of working under load checks should be made for leakages from connections and ensure that all components remain firmly fixed to their supports.

The motor is factory tested and does not require a wear-in period.

## Replacement Parts

### 826-2 Blade Carrier Assembly

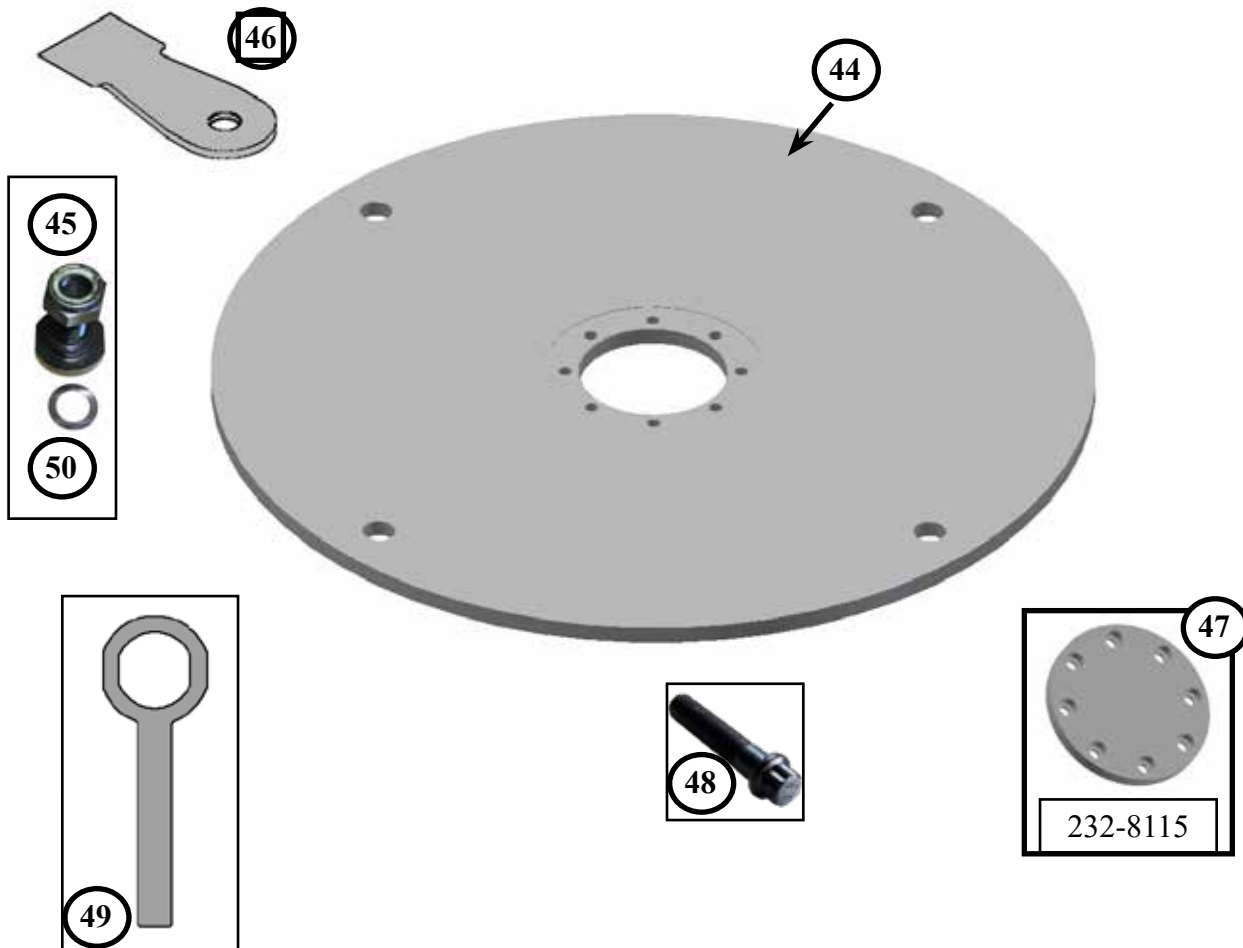

Ref. No.	Part No.	Qty	Description
44	232-2826	1	6' Blade Bar (Bolt On Style) Series 2
45	T5-165NB	4	165 Blade Bolt & Nut 2 3/4" Socket, Torque 1200 - 1500 ft/lbs.
46	UK-165NB	4	Blade (2 3/4in Hole) SOLD IN MATCHED PAIRS ONLY
47	232-8115	1	Bottom Cover Plate
48	FHC912C40	8	Bolt, 12 point flanged 3/4-10 x 2 1/2" - Blade Bar to Flanged Hub
NS	255-42810	1	Thread Locker 10 mL Bottle
49	TC-165 Wrench	1	165 Bolt Wrench
50	T5-165S	varies	Blade Bolt Shim, (used, if blade is binding under blade bar)

NS - Not Shown

## Revisions

Date	Page	Change Made

## Bolt Torque Specifications

Size	Recommended Torque			
	Grade 5		Grade 8	
	Coarse	Fine	Coarse	Fine
1/4	6.3	7.3	9	10
5/16	13	14	18	20
3/8	23	26	33	37
7/16	37	41	52	58
1/2	57	64	80	90
9/16	82	91	115	129
5/8	112	128	159	180
3/4	200	223	282	315
7/8	322	355	454	501
1†	483	541	682	764

**DANGER! TO AVOID SERIOUS PERSONAL INJURY OR DEATH THIS ROTARY CUTTER MUST NOT BE ATTACHED TO ANY POWER UNIT THAT DOES NOT HAVE A SHATTERPROOF DOOR (OR FRONT SHIELD) INSTALLED.**

**Thank You,  
for purchasing a Brown Brush Cutter.**

From Serial Number  \* \* \* B 0 0 0 1 \_

Brown 826B  
Version 1.0.0  
July 2021



6001 E. Hwy 27 - Ozark, AL 36360  
334.795.6603 - Fax: 334.795.3029