

# T6 SERIES

T6.145 | T6.155 | T6.160 | T6.165 | T6.175 | T6.180



# Rely on T6 for unrivaled performance.

T6 Series all-purpose, heavy-duty tractors are redesigned, restyled and ready for the next age of farming. New Holland has combined uncompromised power with the most advanced technology. They give you unmatched comfort, visibility and maneuverability with higher power and performance that you can feel.

## Powerful productivity

Productivity comes standard thanks to a choice of five models with an endless list of options including a front hitch and PTO, a choice of front axles, as well as a choice of transmissions. The T6 has you covered, from haymaking to loader work and row-crop applications. ECOBlue™ HI-eSCR 2 engine technology not only provides Stage V emissions compliance, the system maintains total fluid efficiency (fuel and AdBlue DEF) compared to Tier 4B engines, and gives you a significant performance advantage, along with 25% longer service intervals. The enormous 42% torque rise and Engine Power Management provide you with up to an additional 34 horsepower to maintain productivity in even the most demanding conditions.

## Operating comfort

At New Holland, we believe a long, hard day in the field shouldn't feel like one. That's why we designed the Horizon™ cab for day-long comfort and productivity. The exceptionally low 69-decibel noise level and smooth Comfort Ride™ cab suspension help you feel at ease while you work.

Up to 16 bright LED working lights

## DESIGNED FOR THE NEXT AGE OF FARMING

Sleek, functional styling

New Holland LED signature lights

Stage V ECOBlue™ HI-eSCR 2 engines, up to 175 maximum horsepower

Terraglide™ suspended front axle option

Tight-turning SuperSteer™ FWD axle option as small as 14.1 feet. (depending on wheel spacing)

Terralock™ automatic traction management

Headland Turn Sequencing II system





ISO BUS Class 3 compatibility

High-visibility roof panel

Factory installed integrated IntelliSteer auto guidance option

Model	Engine	Max. Boosted Engine HP	Rated Engine HP	Rated PTO HP
T6.145	4.5L, 4-cylinder	145	116	95
T6.155	4.5L, 4-cylinder	155	125	105
T6.160	6.7L, 6-cylinder	165	135	115
T6.165	4.5L, 4-cylinder	169	135	110
T6.175	4.5L, 4-cylinder	175	145	122
T6.180	6.7L, 6-cylinder	175	145	126

Premium seat options

Horizon™ cab with low noise levels of a mere 69 dB(A)

Optional Comfort Ride™ cab suspension

Renowned Electro Command™ Semi-Powershift transmission

Optional proven Auto Command™ continuously variable transmission (CVT) is available

Industry-leading Dynamic Command™ transmission is available

Also available in economical, maneuverable 2WD

Standard 104-inch wheelbase and up to a 15.1-foot turning radius (dependent on wheel spacing)

# Engineered by design to meet your needs.

T6 models range from 95 to 126 PTO horsepower, in packages to suit your needs.

Customer Need:	Perfect for basic haying needs and farm chores	Increased performance and comfort for haying and loader operations	High-performance and luxury features for increased operating efficiency	Advanced features that boost productivity and comfort	Ultimate haying and chore tractor with premium features and the highest performance
<b>Packages:</b>	<b>Electro Command™ Value</b>	<b>Electro Command™ Plus</b>	<b>Electro Command™ Elite</b>	<b>Dynamic Command™</b>	<b>Auto Command™</b>
Transmission	Semi Powershift	Semi Powershift	AutoShift	8-step Powershift	CVT
Hydraulics	21.1-gpm fixed pump	29.9-gpm CCLS pump	29.9-gpm CCLS pump	29.9-gpm CCLS pump	33.5-gpm CCLS pump
Hydraulic Remotes	2 mechanical	2 mechanical	2 mechanical	2 mechanical	3 electro hydraulic
Comfort Ride™ Cab Suspension	NA	Optional	Standard	Optional	Standard
LED Worklights	8	12	12	12	12
Auto Guidance	NA	Optional	Optional	Optional	Optional
ISO BUS	NA	NA	II Optional	Class 3 Standard	Class 3 Standard





HORIZON™ CAB	6-7
OPERATOR ENVIRONMENT	8-9
CONTROLS	10-11
PRECISION LAND MANAGEMENT	12-13
ENGINE	14-15
ELECTRO COMMAND™ TRANSMISSION	16-17
DYNAMIC COMMAND™ TRANSMISSION	18-19
AUTO COMMAND™ TRANSMISSION	20-21
AXLES & TRACTION	22-23
LOADER & REAR LINKAGE	24-25
PTO & HYDRAULICS	26-27
SERVICE & ACCESSORIES	28-29
SPECIFICATIONS	30-31

### Tailored transmission offering

New Holland provides you with a selection of award-winning transmissions.

The **Electro Command™ semi-powershift transmission**, featuring 4 ranges, is the perfect match for the materials handling jobs and light field work of livestock, dairy and hay farms.

The **Dynamic Command™ 8-step powershift transmission**, featuring 3 ranges, is a no-compromise, superior solution for contractors, mixed farms, dairy and hay operations that require a multipurpose tractor for cultivation as well as hauling and transport between locations.

The **Auto Command™ Continuously Variable Transmission (CVT)** is built for the demands of large farms, contractors or specialized crop operations that log high annual tractor hours completing challenging field work, long-distance hauling and speed-critical applications.

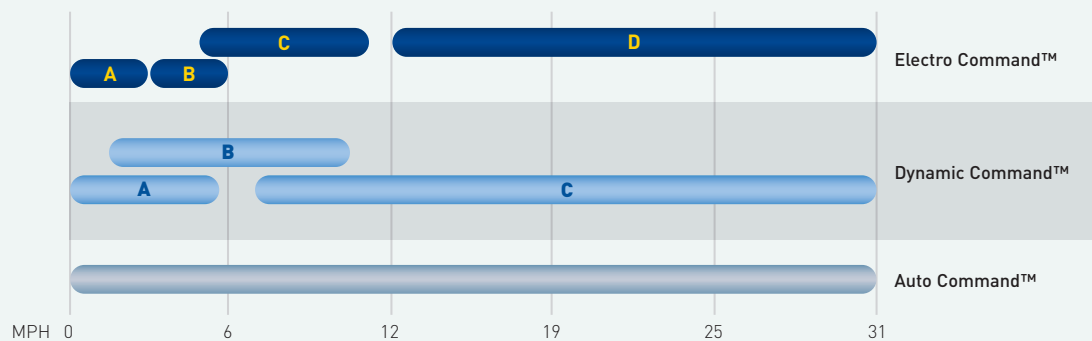

### Additional choices tailored for you

New Holland believes in the power of choice, so you can outfit your T6 tractor to perfectly suit your needs. Choices include a selection of hydraulic system, the number and type of hydraulic remotes, optional loader and the optional HTS II headland turn sequencing system. You also get the choice of four different front axles – the economical and maneuverable 2WD axle, standard FWD axle, the Terraglide™ suspended front axle for a silky-smooth ride or the SuperSteer™ front linkage axles for turn-on-a-dime maneuverability. In addition, two roof choices are available on every Electro Command T6 model. The low-profile option (Value Package) is the perfect choice for livestock farmers who need to enter traditional buildings with low clearance – without sacrificing headroom in the cab.



# Horizon™ cab

## More space, better visibility.

---

Want all-round visibility? That's what you get with New Holland's industry-leading Horizon™ cab. Whether you're around the barn, in the field or on the road, you have an uninterrupted, productivity-enhancing view. The large, single-piece front windshield offers a perfect view no matter the weather or field conditions. The sun visor protects you from the harshest rays. Working with a front loader? Select the standard high-visibility, fully openable (fixed on Value models), transparent roof panel, which affords a perfect view at maximum loader extension from the comfort of your seat. Elite and Auto Command™ models feature exterior telescoping heated mirrors and rear wiper/washer to enhance your all-around visibility. Whisper quiet comfort is courtesy of a mere 69-decibel cab noise level.



### Control the climate of your cab

The air conditioning system features dual-zone technology to guarantee high performance in even the hottest summers and in the very bitterest of winters. Operators can individually position up to 12 vents to control the airflow for ultimate all-body comfort or super-fast windshield defrosting. Controls fall perfectly to hand and can be intuitively adjusted while on the move. Automatic Temperature Control (Optional) automatically maintains the temperature you set for ultimate comfort.



### Control center

The controls for heating and air conditioning, lighting, radio, and additional storage slots are grouped in an ergonomic cluster. A deluxe Bluetooth compatible radio with high-performance speakers is available. Not only can you take your phone calls hands-free, you are also able to listen to your favorite tunes either directly from your MP3 player or via a USB memory stick.



### An armrest to suit you

Dynamic Command™ and Auto Command™ tractors are equipped with New Holland's award-winning SideWinder™ II armrest, complete with the CommandGrip™ handle and optional IntelliView™ IV monitor.

### Eyes in the back of your head

The optional enlarged heated wing mirrors feature an electronically adjustable top section for the best possible view of the road during high-speed transport. The adjustable lower section has been designed to effectively counteract blind spots.

# The ultimate in farming comfort.

New Holland brings you a top-rated seat offering, with three different choices. All seats benefit from improved cushioning. These firmer, more durable seat cushions provide outstanding comfort whatever the terrain. An optional, full-sized upholstered instructor seat folds down to provide a work surface when not in use.

## Comfortable seats for a smooth ride

**The Auto Comfort™ seat** offers a premier seating experience. With ventilated technology, low frequency suspension and heating, this is perfect for operators who spend extended hours in the tractor.

**The Dynamic Comfort™ seat** boasts low frequency suspension to effortlessly cushion you from the harshest bumps to keep you enjoying a super smooth ride.

**The Standard Comfort seat** delivers dependable performance and is perfect for those of you who want to feel more connected to your tractor.

Both the Dynamic Comfort and Standard Comfort seats benefit from an innovative swiveling backrest that is unique in the industry, and makes working with rear mounted attachments even more comfortable.

## Comfort Ride™ cab suspension option

Select a T6 tractor equipped with Comfort Ride so you enjoy an extra-smooth ride over uneven fields or bumpy roads. This simple mechanical system uses two rubber isolators at the front corners of the cab, and a swaybar and two spring-loaded shock absorbers at the rear of the cab.







### Auto Comfort™ seat

The ventilated Auto Comfort™ seat offers a premier seating experience. With automatic weight setting, active suspension, heating and even ventilation system that cools and removes moisture, this is perfect for operators who spend extended hours in the tractor. Seat covering is in blue and grey leather.



### Dynamic Comfort™ seat

The Dynamic Comfort Seat boasts an enhanced low frequency suspension mechanism. The stitched cushions, finished in a stylish mixture of leather and cloth, also feature two stage heating.

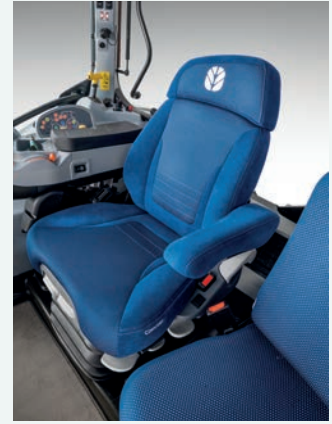

### Comfort seat

The standard Comfort seat uses a low frequency suspension unit. Cushions are finished in a durable dark blue cloth. All seat controls are easily identified ensuring seat adjustments are quick and easy.



Both the Dynamic Comfort and Comfort seats benefit from an innovative swiveling backrest, designed to provide upper back support which significantly increases comfort when the seat is turned to monitor rear mounted implements.

## Lighting the way.

Bright LED work lights are standard equipment. A flexible lighting package option offers you the choice of up to 16 LED work lights, each brighter and consuming less energy than the lights on previous models. The front and rear cab roof can be fitted with up to six lights each, plus four mid-position cab LED lights add up to 16 work lights. These high level work lights light up your work area while the front hood light lights up the road for transport.



You can angle these LED lights to suit the application, creating a broad spread of light that turns night into day.



LED lights are efficiency itself: more light, more durability, less power consumption.



The signature running lights are a work of art. Look closely and you'll see a New Holland leaf nesting inside. It's the details that make the difference.

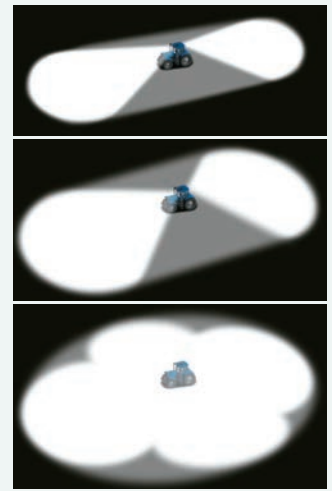

### Choose a lighting package to suit you

There are three cab lighting packages available, consisting of eight, twelve and sixteen LED cab lights in various configurations, to suit your individual requirements.

# SideWinder™ II: the ultimate ergonomic farming experience.

The T6 Dynamic Command™ and Auto Command™ tractors offer sophisticated features that are easy and intuitive to access. How? Well, we listened to customers and developed the SideWinder™ II armrest to make everything simpler. All key controls are accessed from the armrest. Throttle, transmission and hydraulics. Everything you need to control is intuitively laid out. Furthermore, you benefit from the SideWinder II know-how that has been perfected on T7, T8 and T9 tractors!

## IntelliView™ IV touchscreen monitor

The optional 10.4-inch, wide-screen IntelliView™ IV display gives you all the information you need at a glance. You get fingertip adjustment of all key settings. ISO BUS Class 3 (Dynamic Command and AutoCommand tractors only) uses the tractor monitor to control the baler and the baler control functions of the tractor for maximum productivity. On Plus and Elite models, ISO BUS Class 2 allows you to control all of your implements — balers, mowers and more — using your T6 tractor monitor.



The button on the rear of the CommandGrip™ give access to additional functions.



The soft-touch buttons are backlit to make selecting controls in the dark even easier.



## Electronic SideWinder™ II adjustment

Move the armrest to the position that suits you.



## Sidewinder™ II with mechanical remotes

Dynamic Command™ tractors feature a specifically designed SideWinder™ II armrest with modern mechanical hydraulic controls. If you choose optional electro hydraulic remotes for your Dynamic Command T6 tractor, you benefit from the same SideWinder II armrest featured on Auto Command™ CVT models.

Fingertip control for up to two remote valves, which can both be configured with remote valve management.

Optional, Headland Turn Sequencing II (HTS II). Press to record, store and activate automated headland turn.

Optional IntelliSteer® auto-guidance, automated steering engagement.

Rear linkage raise/lower. Front linkage raise/lower (push simultaneously with the CommandGrip™ rear button).

Forward reverse shuttle switch.

Multi-function joystick. The joystick can be set to operate the front 3-point hitch, loader or remote valves.

Personalized positioning of the hydraulic joystick and rear linkage mouse available as a factory-fit option.

Rear linkage mouse. Lift heavy mounted implements with absolute precision.

Electronic remotes. Easy to reach paddles provide fingertip hydraulic operation. Flow and timing can be simply adjusted through the IntelliView™ IV touch screen.

Ergonomically positioned hand throttle

Full access to further advanced controls under the padded armrest.

Electronic SideWinder™ II adjustment.

Drop control. Select a lower maximum engine running speed to save fuel.





10.4-inch, wide-screen IntelliView™ touchscreen monitor

Select paddle or joystick control for remote valves 3 and 4.

Easy access to advanced features. Push the symbol. Activate the feature. The Integrated Control Panel, ICP, makes it simple to access advanced operating features.

Auto PTO disengages and reengages both the front and rear PTO during a headland turn.

Throttle up to your desired engine speed, select Engine Speed Management, and the speed is fixed.

Engage Terralock™ and it will automatically manage four-wheel drive and differential lock selection.

Press the Headland Turn Sequencing II button to record and replay the functions you use most frequently

Three point hitch levelling and top link extension at the touch of a button, or assignable to any remote valve with remote valve management.

Rear three-point hitch raise/lower function

Front and rear PTO engagement control switches



# Open. Connected. Smart. Supported.

New Holland's approach to precision farming, and New Holland Precision Land Management (PLM™) systems, can be summed up in four words:

- Open:** Works across your entire operation, even in mixed fleet and aftermarket operations
- Connected:** Allows for seamless and timely sharing of data and knowledge
- Smart:** Provides intuitive interface and automation, making New Holland equipment easier to own and operate
- Supported:** Assistance through New Holland dealers, YouTube accessible how-to videos, and the PLM Solutions app



New Holland PLM includes a full range of precision farming solutions that can be used with any machine or farming application. Controls are intuitive and user-friendly so you can use PLM Solutions with confidence.

The New Holland PLM offering extends throughout the entire crop cycle and includes many available components so you can customize a system to fit the needs of your operation.



## PLM™ guidance solutions

**IntelliSteer™** system is a fully integrated New Holland-designed and -developed automatic steering system. Available from the factory or as a retrofit package, it dramatically enhances operator performance and comfort, and maximizes your productivity, efficiency, yields and profits. Ensuring pass-to-pass accuracy from 6 to 9 inches through sub-inch accuracy year over year with RTK and RTK+ networks, IntelliSteer is the natural choice for precision work in even the most demanding conditions.

**IntelliTurn™** (intelligent end-of-row-turn) system facilitates an automatic end-of-row-turn feature for tractors equipped with the IntelliSteer system. It improves efficiency by automatically plotting and executing the most efficient turn path to minimize "out of work" time during the turn, and ensuring the implement reenters the work area inline on the desired path. IntelliTurn's industry exclusive Auto Speed feature dynamically plans and modifies the turn path based on vehicle speed when approaching the turn and automatically chooses the appropriate turn style — lightbulb, constant arc or extended path — and executes it flawlessly.

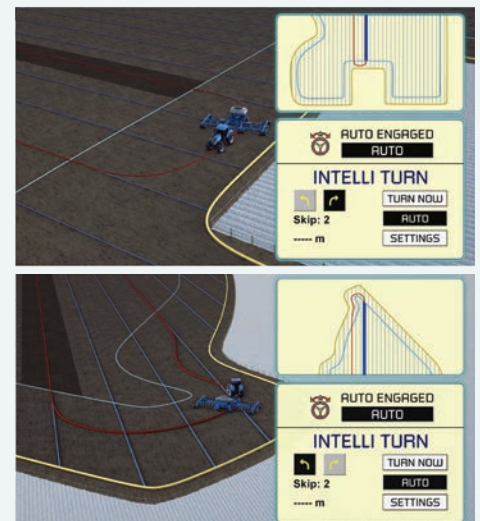



## PLM™ crop management solutions

**IntelliRate™ control** is a variable rate and section control system that allows you to control rate and flow applications on mixed fleets of implements using an integrated single display solution: the New Holland IntelliView™ IV display.

- **Automatic section control** to switch on/off up to 48 individual rows
- **Variable rate application control** controls material applications including liquid and NH<sub>3</sub>, reads prescription maps to manage field variability, and uses applied mapping to track varieties and hybrids
- **Manure management** for liquid spreading or dry spreading
- **Monitors and records planter population rates**



WITHOUT SECTION CONTROL



WITH SECTION CONTROL



**IntelliBale™** technology allows the Roll-Belt™ baler to communicate with your tractor, increasing productivity, reducing operator fatigue, assuring uniform bale size and reducing fuel consumption. IntelliBale brings the tractor to a halt as soon as the bale reaches the pre-set diameter, automatically begins net wrap application and raises the tailgate. A sensor on the bale ramp tracks the complete process and closes the tailgate as soon as the bale has been ejected. A signal alerts the operator to move forward.



## PLM™ data management solutions

**PLM™ Connect** uses either a factory- or dealer-installed modem to give machinery the ability to share live machine data. You can make real-time decisions using the very latest information and share machine data with your local dealer, as well as share field data with third-party suppliers as you see fit.

**PLM™ desktop software** gives you the ability to use increasingly sophisticated monitoring and management techniques. Choose from four PLM software packages to match the needs of your operation.

- **PLM™ Viewer** is a free package that allows you to view and print all of your field data
- **PLM™ Mapping** allows you to edit and manage your field data to develop prescription plans and maps
- **PLM™ Books** adds accounting functions onto the mapping abilities provided by the Mapping software
- **PLM™ Water** is designed for those interested in water management through field leveling and drainage design



## PLM™ support solutions

New Holland knows that when you require support and assistance, you don't want to wait. That's why we've developed a three-pronged approach to PLM™ support. A large selection of how-to videos posted on the New Holland NAFTA **YouTube Video Channel** help answer your day-to-day questions. The new **PLM Solutions App** is available for download on both iTunes and the Google Play App Store, and walks you through deciding on the right PLM solution for you and provides instruction on how to set up and run many of the PLM features. And, of course, you are encouraged to contact **your local dealer or the New Holland Support Line** to discuss technical issues.

# Powerful, responsive and efficient.

With rated power that spans from 116 to 145 horsepower — and with up to an additional 34 horsepower on tap with Engine Power Management (EPM) — a T6 tractor tackles even your most demanding tasks.

All five models are powered by ECOBlue™ HI-eSCR 2 (High Efficiency Selective Catalytic Reduction) engines developed by New Holland's engine development partner, Fiat Powertrain Technologies (FPT). These engines, which comply with the even more stringent Stage V emissions standards, give you power without compromise. Because of our continued commitment to be the Clean Energy Leader, New Holland and FPT have embraced Stage V standards for their considerable performance, efficiency and service advantages. New T6 engines deliver:

- **25% longer service intervals** to reduce operational cost and increase uptime—engine oil interval is extended to 750 hours and the driveline/transmission oil interval is now at 1,500 hours.
- **Greater performance** — with more power, torque, torque back-up and engine power management, all while maintaining outstanding transient response.
- **Efficient operation** — fluid consumption (diesel plus AdBlue) is the same or better than Tier 4B.
- **Simplicity** — patented FPT engine system design means no Exhaust Gas Recirculation (EGR) for a higher power potential, while the reduced cooling system delivers more efficient operation.
- **Consistency** — no change in vehicle operation between Stage V and Tier 4B engine solutions.

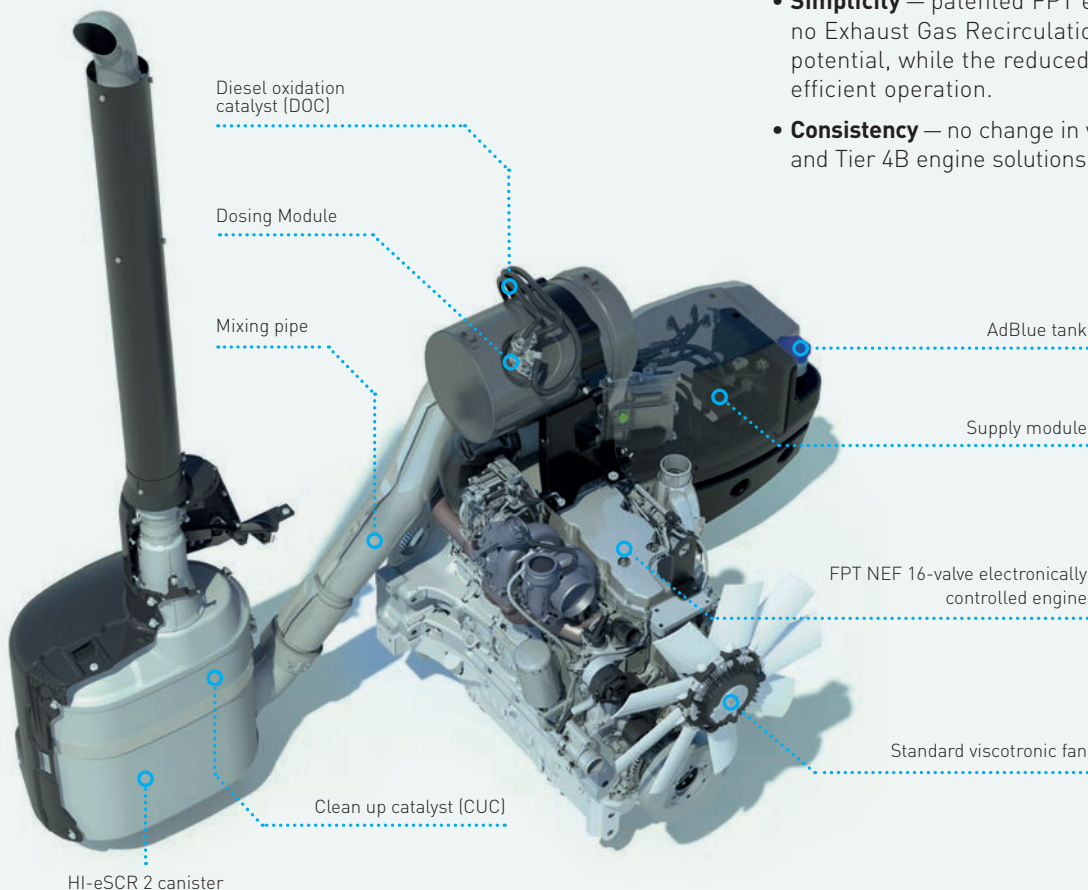

The ECOBlue™ HI-eSCR 2 system is maintenance-free, requires no filter replacement or mechanical cleaning of components, and doesn't need a Diesel Particulate Filter (DPF). New Holland's catalyst management strategy ensures that the after-treatment system maintains its efficiency with minimal impact to the tractor's operation — without the need for regular parked regeneration.

## ECOBlue™ HI-eSCR explained

An evolution of the existing ECOBlue™ SCR system, New Holland ECOBlue HI-eSCR 2 technology is an after-treatment system allowing the engine to breathe clean, fresh air to optimize combustion, torque rise and fuel efficiency. It also provides the highest NOx (Nitrogen oxide) conversion efficiency in the industry. This multi-patented system uses a dedicated closed loop system to continuously monitor the NOx levels in the exhaust gases, ensuring that during every cycle the precise amount of AdBlue® is injected to achieve NOx conversion of over 95%, all while guaranteeing low fluid consumption.

## Torque rise and response that outperforms previous T6 models

T6 Stage V engines have some impressive numbers — numbers that not only look good on paper, they translate into increased lugging power and efficiency. T6 engines achieve better performance by maximizing power output from each cylinder. The new engine control unit brings the engine to maximum torque more quickly and holds through the lower RPM longer to outperform former T6 Series engines.

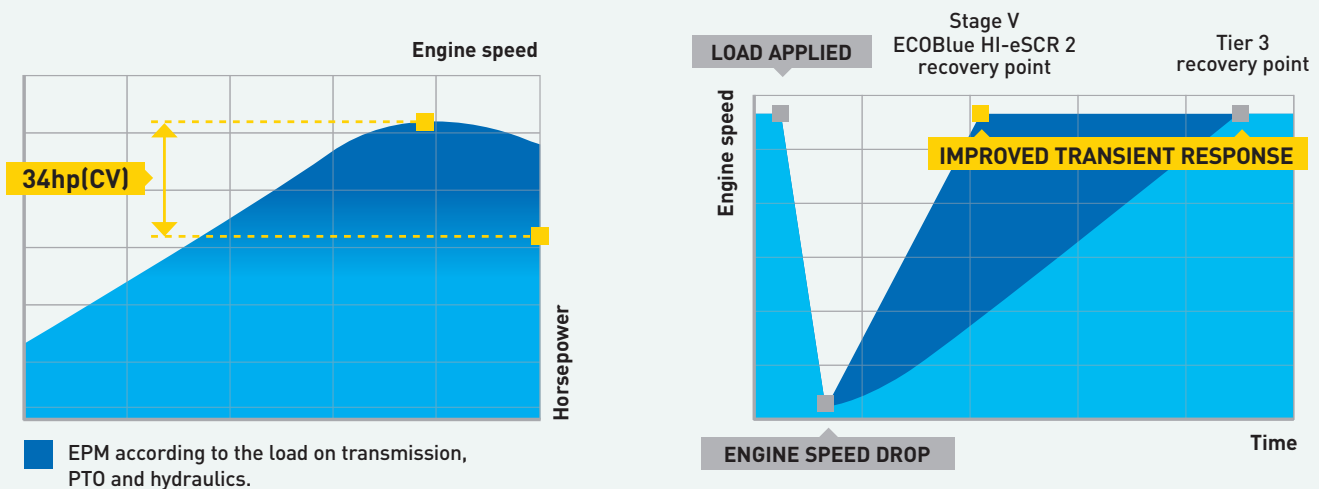

## Engine Power Management (EPM) with power boost

T6 engines deliver extra horsepower when under load — a boost above rated horsepower — to get you through tough conditions. On a T6.165 tractor, EPM will deliver up to 34 horsepower extra, but only when it is needed, to maintain performance.



## The importance of transient response

Transient response is your productivity guarantee. Put simply, since your T6 engine breathes only clean fresh air, with no exhaust gas recirculation, it can react even quicker when placed under load — a lot more quickly in fact — so when you're transporting fully loaded trailers or grain carts and you encounter a hill, you'll be able to maintain constant forward speed with no slow down.

## Constant rpm with engine speed management

In applications where a constant PTO speed is required, just select Engine Speed Management to ensure the speed is maintained even under changing loads. In many applications, this allows you to maintain a fixed forward speed in difficult terrain.

## The same total fluid consumption

Even with increases in horsepower, torque and lugging ability compared to previous T6 models, fluid use (fuel and DEP) remain unchanged.

# There's an Electro Command™ transmission geared for you.

New Holland knows that every farm has different requirements, and that intelligent innovation also means offering tried and tested solutions to improve efficiency. The Electro Command™ semi powershift transmission offers clutchless gear changes to reduce fatigue, and gear shifting is taken care of for you with the auto mode on transmissions with AutoShift™. If you put a lot of road mileage on your tractor, choose the 31-mph (50-kph) transmission (FWD only) to speed up your travel between fields or jobs. Or, select the Economy transmission that operates at reduced engine speed to further enhance your fuel economy.

- 16x16 Electro Command semi-power shift, 19 mph (30 kph) – 2WD only
- 16x16 Electro Command semi-power shift with AutoShift, 19 mph (30 kph) – 2WD only
- 16x16 Electro Command semi-powershift, 25 mph (40 kph)
- 16x16 Electro Command semi-powershift with AutoShift, 25 mph (40 kph)
- 17x16 Electro Command Economy semi-powershift with AutoShift, 25 mph (40 kph)
- 17x16 Electro Command Fast Mover semi-powershift with AutoShift, 31 mph (50 kph)
- 32x32 Electro Command semi-powershift with AutoShift and Creeper, 25 mph (40 kph)

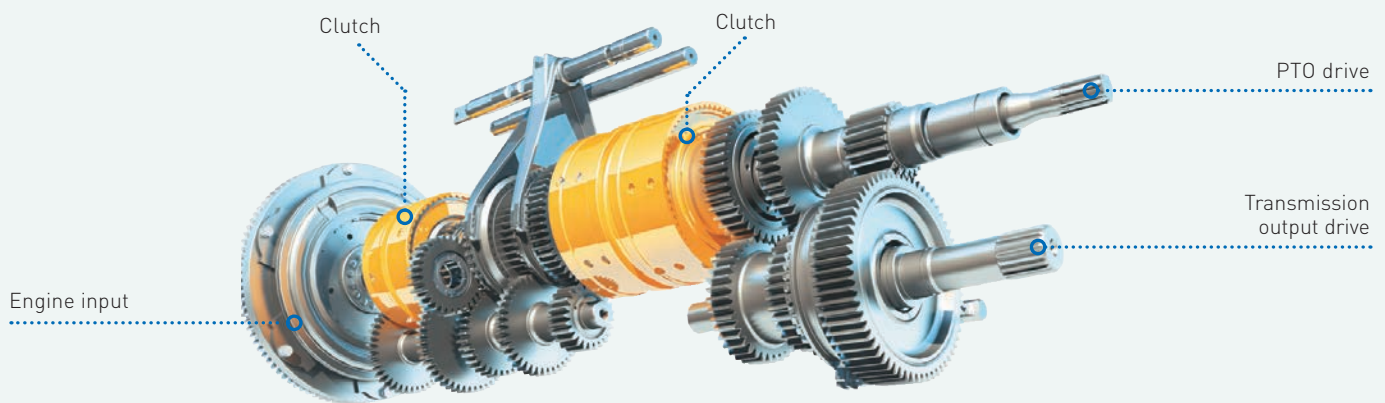



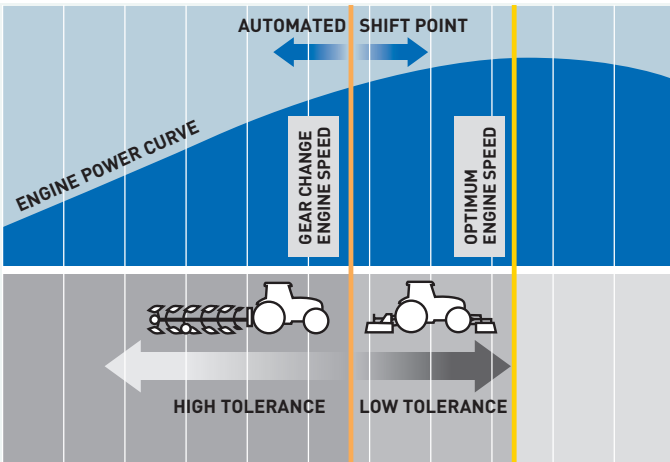

### Auto modes for comfort and productivity

Easy to set up and truly effective, Auto Transport and Auto Field modes can really reduce the effort required to operate a T6 tractor over a long working day. With Auto Transport, the tractor shifts seamlessly like an automatic vehicle. Auto Field mode manages both the engine speed and transmission to optimize performance and economy. In PTO applications, where a constant engine speed is the priority, the system will select the transmission ratio to match the load on the engine. In draft applications, engine speed is allowed to drop to fully exploit the available torque rise before selecting a lower ratio under load conversion of over 95%, all while guaranteeing low fluid consumption.



### Electro Command™

Electro Command tractors with mechanical mid-mount valves have the tried and true standard control arrangement which includes powershift control buttons on the range shift handle as well as on the console for operator convenience.



### Efficient multi-function handle

You can now specify an ergonomic seat armrest-mounted multi-function handle that falls perfectly to hand and is ideal for operators who frequently change gears. The multi-function handle is standard on all T6 models with the exception of tractors equipped with mechanical mid-mount valve.



### Ergonomic power shuttle

You can operate the convenient, column-mounted electro hydraulic power shuttle without taking your hand off the wheel for increased safety during loader work. You can even regulate the shuttle aggressiveness setting with an ergonomically positioned switch. Select soft for general field work, standard for daily tasks and the aggressive position for near instantaneous direction changes during loader work. You can even change the setting while on the move.

### Memory shuttle

The Electro Command features an innovative memory shuttle system that saves you money, and speeds up cycle times. First, select the ratio you need in forward, shuttle and then shift to your desired reverse ratio. From now on, the tractor will automatically shuttle between your chosen forward and reverse gears. Simple.

# Dynamic Command™ transmission delivers dynamic operation in every situation.

New Holland designed the industry-leading 24x24 Dynamic Command™ transmission to offer even more gears in the most frequently used operating ranges, allowing you to perfectly match the speed of your T6 to the task in hand. The nearly instantaneous direction changes provided by the power shuttle makes field work and especially loader work more simple and efficient.

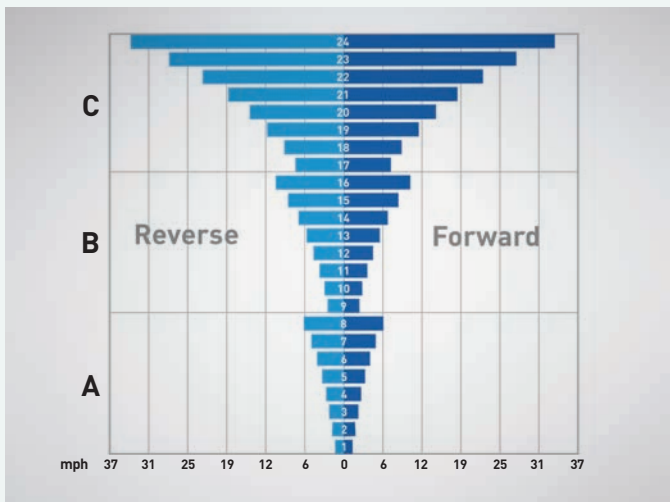
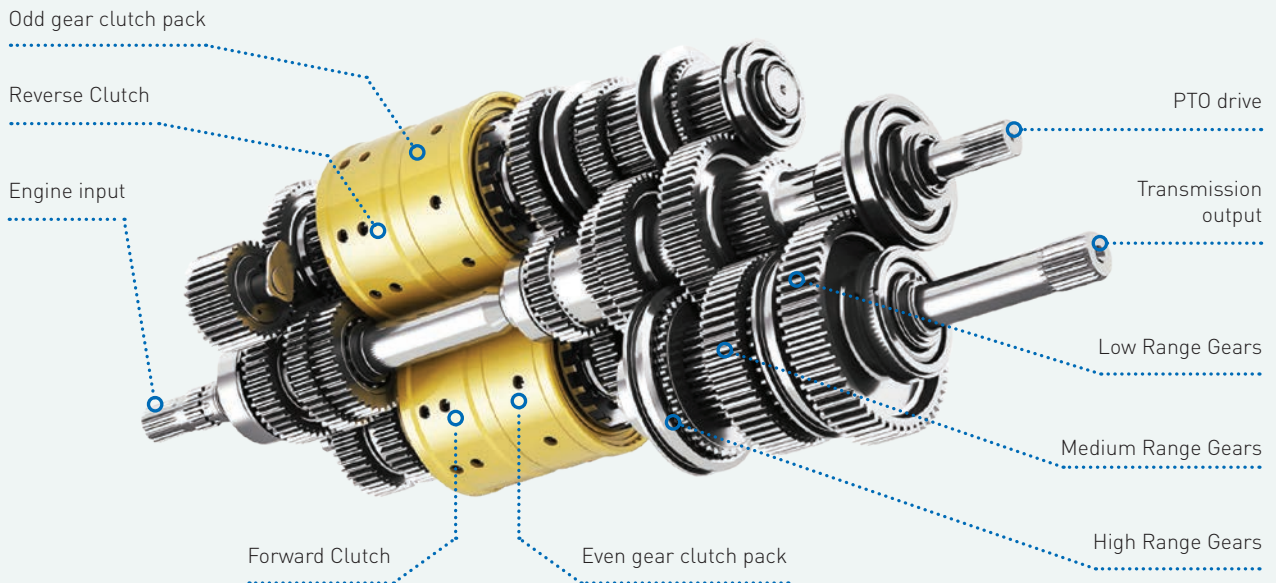

### Three-range, eight-step semi-powershift

The 24x24 Dynamic Command™ transmission provides smooth, uninterrupted power and effortless operation. You can shift between eight gears under load without having to change ranges. You get a full 24 gears in forward and reverse with speed overlap that allows you to easily select the best range for your application — with no break in torque as you move through eight gears.

### A true power shuttle

A dedicated gearbox controls the true power shuttle for accurate, near-instantaneous forward/reverse shifting. You can program forward and reverse gears, as well as set the shuttle shift aggressiveness to match your preferences. This responsive power shuttle speeds up loading and hauling farm yard tasks.



### Clutch-free loader work with Dynamic StartStop

The advanced Dynamic StartStop feature means there's no clutching needed to make loader work smoother than ever. Simply press the brake and your Dynamic Command tractor comes to a standstill. Release the brake pedal and drive reengages and puts the tractor in motion.

### 25 mph, 31 mph or creeper speeds

You decide. For transport intensive operation the 25-mph (40 kph) Economy or the 31-mph (50 kph) Fast Mover options offer an efficient way to get between field and back to base, all while saving fuel and with lower in-cab noise. At the other end of the scale, a creeper option can be specified so that you can go as slow as you need.



### Save time and effort with new CustomSteer™ option

Available for all T6 Dynamic Command models, the CustomSteer™ feature allows operators to turn fully from lock to lock with as little as one rotation of the wheel with precision control. You can choose a steering ratio preference from 1:1 to 1:4 for quicker maneuvering at the headland, reversing with trailers, or during repetitive loader work. It saves time and reduces fatigue.

### Rapid acceleration when you need it with kick down

When you need that extra bit of speed, such as when accelerating from a stop, the Dynamic Command™ transmission automatically 'kicks down,' selecting a lower gear for maximum acceleration. When you have achieved cruising speed, the gearing will automatically revert to the most efficient available.

### More advanced features boost productivity

The Auto Shift option builds on the productivity of the Dynamic Command transmission by allowing you to automatically move through the gears within a range based on engine speed. You also get these productivity-boosting features with the Auto Shift option:

- **Smart Range Shift:** Skip overlap gears when moving between ranges for rapid acceleration.
- **Auto Shift:** Automatically shifts within a range so you can pay attention to driving.
- **Ground Speed Management (optional):** Maintains a target ground speed by automatically shifting and throttling up or back based on load.
- **Dynamic IntelliShift™:** This system analyzes engine speed, transmission shaft speed, ground speed and more for smooth, seamless shifting.
- **Transport Power Management™:** When travelling over 14 mph, this system automatically switches the engine to a power curve that provides more consistent acceleration rates.

### At a glance gear information

A dedicated screen displaying transmission gearing information has been positioned to the front of the armrest, so that it is easy to see at all times.



# Efficient Auto Command™ transmission offers advanced New Holland features.

Designed and built by New Holland, the Auto Command™ transmission is available on the T6.145, T6.165, T6.175 and T6.180 models. This Continuously Variable Transmission (CVT) benefits from multiple direct drive points with 100% mechanical efficiency which have been precision engineered to ensure that they perfectly match the most frequently used speeds during field operation. Advanced double clutch control further enhances efficiency. Quite simply, it is the smoothest, easiest to operate, and most productive CVT around.

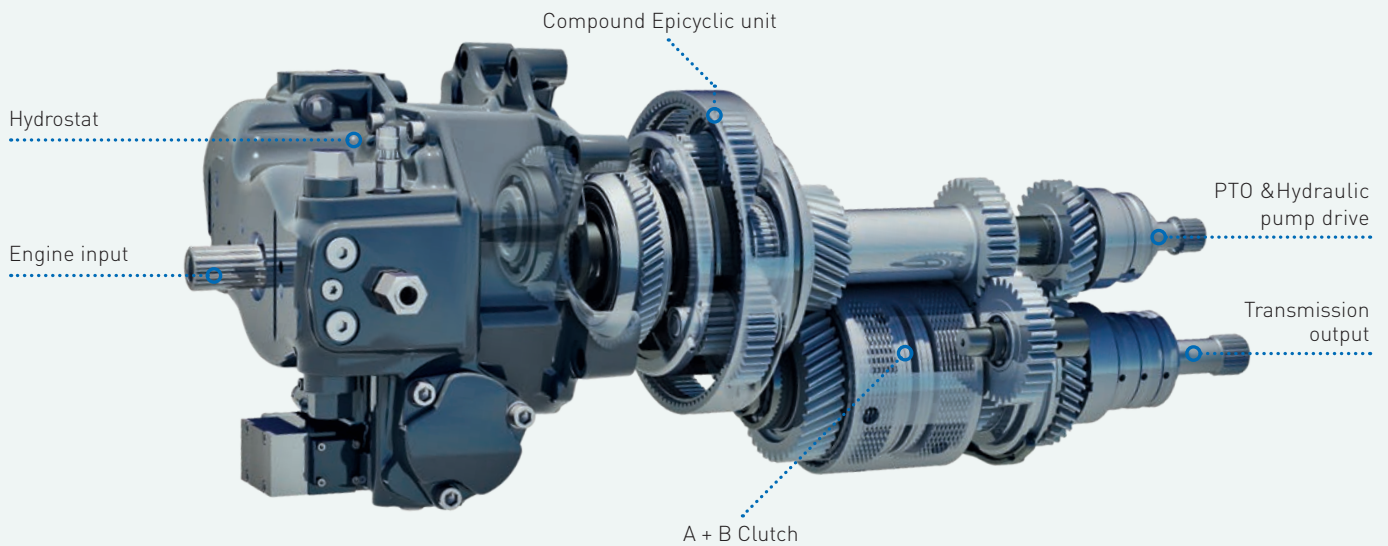

Force-based movement enables the operator to change speed and direction. On the SideWinder™ control console, there is a switch to alter the response of the speed change. Forward speed can also be controlled using the foot pedal.

Target speed adjustment – set a target speed to match your exact needs. Perfect when moving between fields or when crop yields have changed.

Target speed selection – allows you to move between three adjustable target speeds.

#### 4 driving modes to suit your driving style:

**Auto Mode.** Select the desired target speed and Auto Command will match the engine and transmission to maintain it.

**Cruise Mode.** Once a desired operating speed has been achieved, use Cruise Mode to set the transmission to maintain the speed for economy and productivity.

**Manual Mode.** Allows the operator to manually control the required engine and forward speed.

**PTO mode.** As soon as the PTO is engaged, Auto Command will operate to guarantee a constant engine speed.



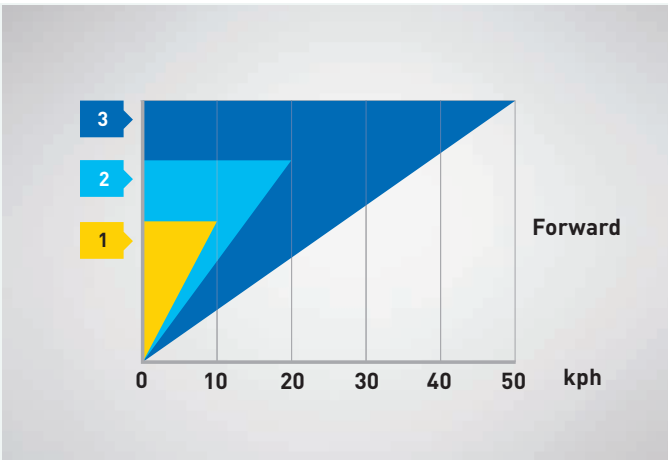

### A speed for every need

Auto Command allows the operator to set a target speed between 0 and 25 mph (40 kph), or 31 mph (50 kph) on the optional transmission, and regulate it to the nearest .06 mph (0.01 kph). No steps. No range changes. Just seamless speed to match your every need.



### Go with the flow—optimum performance with balers, mowers, snow blowers and more

Since Auto Command™ CVT provides you with infinite speed control, you get optimum performance with balers, mower-conditioners, snow blowers and other material flow implements.

### Tailored transmission settings

The multi-award winning Auto Command™ continuously variable transmission now features a three-stage acceleration and deceleration setting. The 'soft' setting is suitable for gentle direction changes, perfect during high speed transport or when working on slippery surfaces. The standard setting has been designed for normal field activities. The super-fast aggressive setting is ideal when near instantaneous direction changes are required.



### Fast direction changes

Changing direction is simple with Auto Command. You can either move the CommandGrip™ handle, use the power shuttle switch on the CommandGrip™ handle or use the steering column mounted shuttle lever.



### Balancing fuel economy and productivity

When working in Auto and Cruise modes, use the droop control button, situated to the right of the operator, to reduce the engine speed at which maximum forward speed is obtained. The result: you reach 31 mph (50 kph) at much lower engine RPM, saving you fuel. In PTO mode, regulate the acceptable reduction in PTO speed before forward speed is reduced. Perfect during tillage in fields of uneven soil types with areas of compaction.

# Greater maneuverability and improved traction.

New Holland's selection of axles is engineered to perfectly match your requirements. All T6 tractors can be specified with structurally light but strong front axles that allow you to get the full productivity of a front loader or front three-point hitch. The overall maximum gross vehicle weight of 20,944 pounds on all models with FWD optimizes traction and means you've got even more flexibility when using heavy mounted implements or when ballasting. SuperSteer™ axles, when combined with the fully automated headland turn sequencing functionality, enhance

maneuverability and save you time on every headland. All FWD models benefit from a long wheelbase as well as a short turning radius — the best of both worlds! The long wheelbase — from 104 to 110 inches — ensures a smooth ride and stable traction. The short, 14' 1" to 15' 1" turning radius allows for sharp turning and ultimate maneuverability that increases productivity. All T6's come with a robust 10.8-inch flanged rear axle as standard. For operations looking for ultimate flexibility, a 98-inch bar axle is also available.

## Available in 2WD

Now you can take advantage of the comfort and deluxe features of premium T6 tractors without the expense of FWD. With 2WD, you maneuver easily in tight quarters with a loader or mixer/feeder wagon, and make quick headland turns while haymaking.

## Longer wheelbase for all models

- Improved traction stability
- Sharp 15.1' turning radius (standard FWD axle), 55° turn angle
- 14' 1" turning radius with 2WD or SuperSteer, 65° turn angle

Wheelbase - Stage V versus Tier 4A			
T6 Series APH	Stage V	4 Cyl. Tier 4A	6 Cyl. Tier 4A
2WD	96"	N/A	N/A
Standard FWD	104"	94"	103.4"
Suspended FWD	105.7"	96"	105.5"
SuperSteer™ FWD	109.8"	99.7"	109.2"



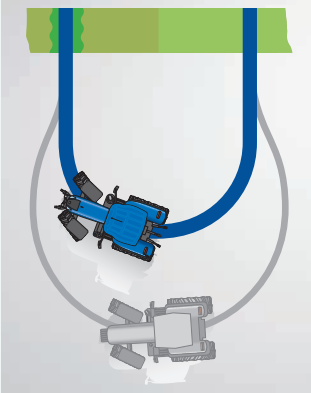

### Less time turning boosts your output

New Holland leads the field in turning performance. Want the tightest turns? Then choose the SuperSteer™ front axle. It extends wheelbase to 110 inches and increases turn angle from the standard 55 degrees to 65 degrees to give you greater agility by decreasing headland turn time by 35%.

### Terralock™ Automatic Traction Management

New Holland's renowned Terralock™ solution is simple to set-up and operate. It automatically manages the engagement of drive to the front axle, locking both the front and rear differentials when needed, and disengages automatically for tighter turns.

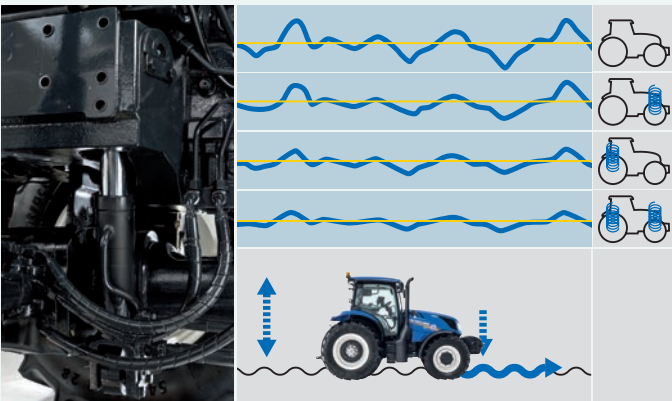

### Terraglide™: your comfort and stability partner

For increased productivity in the field and maximum comfort at high transport speeds, choose the Terraglide™ front axle suspension system. It offers a longer 106-inch wheelbase plus up to four inches of travel, for better stability, control and drawbar pull. Not only does it cushion the operator from shocks when travelling over uneven surfaces, the system maintains contact between the tire and the ground to improve traction. It also features anti-dive and anti-squat logic which prevents excessive suspension movement when lifting heavy three-point hitch implements. The integrated Comfort Ride™ Cab suspension provides up to a 25% reduction in shock loads reaching the operator. The result? Less fatigue over long working days, as whole body movements are significantly reduced.



### Stopping performance

The T6 ensures you safely come to a halt, since four-wheel drive automatically engages when braking to increase safety. The standard heavy-duty brakes offer impressive stopping performance.

# Productivity and flexibility guaranteed.

New Holland knows that full integration is far better than something that has been tacked on as an afterthought. That is why the T6 was designed with a front loader and front three-point hitch in mind. The T6 is fully compatible with New Holland 810LA, 850LA, 855LA and 857LA front loaders. They are the perfect productivity combination. You no longer have to choose between front loader or front hitch. With the T6 you can have both. And, you get a perfect view to the loader at full extension from the comfort of your seat thanks to the optional high-visibility, transparent roof panel.



## Rear three-point hitch

The maximum lift capacity, depending on the tractor package, is a massive 11,650 lbs. (OECD, 24" behind the lower lift link balls, through the range of motion). The rear linkage and hydraulics are designed to work with heavy mounted equipment over extended periods. The system also incorporates integral dynamic ride control shock load protection. This will reduce bounce when travelling with a heavy linkage load at transport speeds. Fender mounted controls for the rear linkage, a rear remote and the PTO are available.



## The perfect fit: front linkage and PTO

T6 tractors are designed to incorporate a fully integrated, factory-fitted, front three-point hitch and PTO. You can access all linkage and PTO controls either from the comfort of the cab, or using the controls conveniently positioned on the hitch itself. Designed specifically for T6 tractors, the hitch lifts up to 6,834 pounds. SuperSteer™ models maintain their super-tight turning since the front linkage follows the turning angle of the front axle. Linkage arms can be folded when not in use, or can be used to carry the new mono block front weight pack.





### Out-see. Outperform. Outlast.

New Holland LA Series loaders provide the best combination of visibility, performance and reliability to increase your productivity during loading, hauling and materials handling jobs. A maximum lift height of up to 13.9 feet and lift capacities up to 5,202 pounds (to maximum height 31.5 inches forward of the pivot pin) mean that no task is too big or too small. The numbers speak for themselves. But there's more. The LA series loaders feature a wide 3.2-inch profile and are manufactured using a fully automated, state-of-the-art welding process for unrivaled strength. Cast and forged components in high-stress areas provide extra strength and contribute to a long lifespan. The sleek curved boom, low cross tube and chamfered design maximizes visibility providing operators with clear sightlines around the loader. Larger-diameter, high-flow cylinders and hoses allow for optimal flow to match the higher hydraulic capacities of the T6 tractor. The optimized Soft Ride system (available as an option) provides an uncompromisingly smooth ride over rough terrain.

### FOPS: your safety partner

New Holland offers you the ultimate in loader peace of mind. T6 Series tractors are fully FOPS (falling object protection system) compliant to guard against injury from falling objects.

Front End Loader Compatibility and Specifications					
Front End Loader Model		810LA	850LA	855LA	857LA
NSL - None Self-leveling / MSL - Mechanical Self-leveling		NSL	NSL	MSL	MSL
T6 Series Tractor with Two Wheel Drive (2WD)		●			
T6 Series Tractor with Front Wheel Drive (FWD)			●	●	
T6 Series Tractor with SuperSteer™ (FWD)					●
Maximum lift height to pivot pin*	ft. (mm)	11.9 [3627]	13.5 [4115]	13.5 [4115]	13.9 [4237]
Clearance with bucket dumped*	ft. (mm)	8.7 [2651]	10.3 [3140]	10.3 [3140]	10.7 [3261]
Reach at maximum lift height*	in. (mm)	27.9 [708]	28.3 [718]	28.3 [718]	35.4 [900]
Maximum bucket dump angle	degree	60	55	56	53
Reach with bucket on ground	in. (mm)	83.8 [2128]	99.2 [2520]	99.2 [2520]	104.3 [2650]
Maximum bucket rollback angle	degree	40	47	47	49
Digging depth*	in. (mm)	3.1 [78]	3.9 [99]	3.9 [99]	4.7 [120]
Lift capacity to maximum height, 31.5" (800 mm) forward of the pivot pin**	lbs. (kg)	2380 [1080]	2932 [1330]	5202 [2360]	4365 [1980]
Breakout force, 31.5" (800 mm) forward of the pivot pin	lbs. (kg)	3439 [1560]	4673 [2120]	5974 [2710]	4894 [2220]
Attachment Type		Euro or SSL Style	Euro Style	Euro Style	Euro Style

\* With base equipment tires/wheels \*\* With proper rear counter balance

## Hydraulic power and PTO flexibility.

---

Have you ever thought about just how much hydraulic flow you actually need? All Value models are fitted with the traditional fixed displacement hydraulic pump as standard. Delivering 21.1-gallons per minute (gpm), the system is more than sufficient for the majority of farming applications. A 29.9-gpm closed-center load-sensing (CCLS) pump is standard on Dynamic Command™ models and optional on Plus and Elite models that will power even the most demanding implements. For the most demanding hydraulic needs, Auto Command™ models offer an impressive 33.5-gpm CCLS system. New Holland has engineered its CCLS systems to operate at peak efficiency, so full hydraulic power is always available at the remote valves and 3-point linkage, but only as much as is needed. The result? Reduced fuel consumption. Regardless of how hard your Electro Command tractor is working, the steering will always remain light and easy to use, and loader cycle times remain uncompromised thanks to a separate 12.4-gpm service pump or optional 17.2-gpm pump when fitted with Class 4 front axle.



### Remote valves

Your T6 tractor can be specified with up to four electronic or mechanical rear remote valves. Also available are up to three mid-mount remote valves to operate the front linkage or a loader. They are controlled via an ergonomic, fully integrated joystick in the cab.

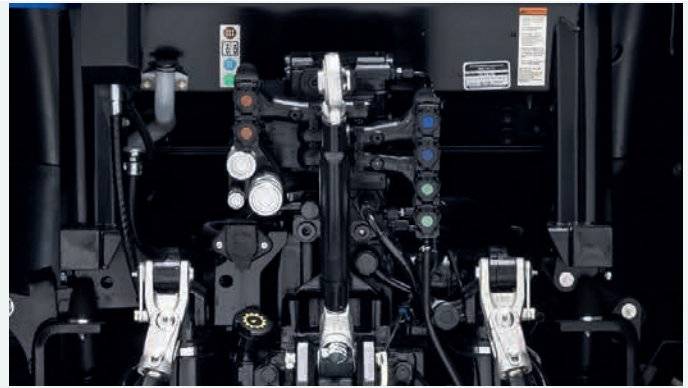

### Even easier hydraulic connection

The hydraulic valve blocks at the rear of the tractor have been split in two to make it even easier when connecting hydraulic lines. The block on the left controls two sets of remotes and the block on the right controls two sets of remotes. In addition a fifth spool diverter and power beyond are also available.



### Direct drive for fuel efficiency

The T6 driveline is designed for optimum power transmission efficiency. All T6 tractors are fitted with a direct drive PTO to minimize power loss between the engine and the implement. The PTO is engaged via a push-pull control, with advanced Soft Start management. This modulates engagement of high-inertia attachments to protect the driveline. The independent PTO comes in 540 rpm or 1000 rpm with a reversible PTO shaft.



### Electronic draft control

A single raise/lower switch makes it simple to lift and return an implement to work during a headland turn. New Holland's ergonomic mouse is positioned just to your right, exactly where you need it, giving you ultimate precision. To fine-tune the system you can use the intuitive controls that are found underneath the armrest.



### Headland turn sequencing II: hassle free repeatability

HTS II is available on models fitted with electro hydraulic remotes. This intuitive system means you can easily record and store all implement sequences and operations at the headland. These can then be played back at the touch of a button. Simple, and a great way to improve repeatability and efficiency and to reduce fatigue when working over extended periods. The headland turn sequencing is standard with the Elite and Auto Command models.

# 360° access for easy maintenance.

The T6 tractor line has been designed to spend more time working and less time for maintenance. All service points are easy to access, and super-long service intervals mean T6 tractors spend more time in their natural environment: the field!

The engine air filter is easy to check, clean or replace, with no need for tools.

Engine oil check and fill points are easy to reach, with no need to lift the hood. This makes routine checks faster and servicing simpler. Enjoy a 750-hour service interval on engine oil changes as a result of Stage V emissions standard.

Single-piece, engine hood opens wide for full service access.



Cooling package opens so all coolers can be accessed for cleaning.

The 10.4-gallon AdBlue® tank's filler neck is narrower than that of the standard fuel tank, which prevents inadvertent filling with fuel.

*Blue Power* / *Un-limited edition.*



**Blue Power Edition**

Farm in style with the Blue Power Edition of the T6.175 Auto Command tractor. The distinct midnight blue color with silver accents, carpeted and leather-trimmed interior add an exclusive look and feel to your everyday work.

**Dealer Installed Accessories**

A comprehensive range of approved accessories to optimize machine performance in all conditions can be supplied and fitted by your dealer.



Change the cab filter easily.

Top off the windshield washing fluid through the rear window.

Hydraulic oil levels can be viewed via a sight glass at the rear of the tractor.

A 60-gallon fuel tank is standard equipment on Dynamic Command™ models. Other T6 models feature a 52.2-gallon fuel tank, which you can augment with an auxiliary modular fuel tank that expands fuel capacity to 58.6 gallons – enough fuel for those extra-long days.



MODELS		T6.145	T6.155	T6.165	T6.160	T6.175	T6.180
<b>Power</b>							
Engine Type		Turbo Diesel with High Pressure Common Rail with Electronic Fuel Delivery Control					
Make / Model		Fiat Powertrain Technology (FPT) NEF					
# of Engine Cylinders		4	4	4	6	4	6
Displacement	cu. in. (L)	274 (4.5)	274 (4.5)	274 (4.5)	274 (4.5)	274 (4.5)	411 (6.7)
Valves per Cylinder		4	4	4	4	4	4
Rated Engine Speed	rpm	2100	2100	2100	2100	2100	2100
Aspiration		Turbo Charger with Air-to-Air Intercooled					
Max Boosted Engine HP		145	155	169	165	175	175
Rated Engine HP		116	125	135	135	145	145
PTO HP		95	105	110	115	122	126
Engine Speed at PTO Speed	540/1000	1969 / 1893	1969 / 1893	1969 / 1893	1969 / 1893	1969 / 1893	1969 / 1893
Emissions Certification		Stage V/Final	Stage V/Final	Stage V/Final	Stage V/Final	Stage V/Final	Stage V/Final
Stage V Emissions System		ECObLue™ HI-eSCR 2 System (Selective Catalytic Reduction; After Treatment only)					
Diesel Fuel Tank Capacity	gal. (L)	Standard Tank - 52.2 Gal (197.2), with Auxiliary Tank - 58.6 Gal (222)					
DEF (AdBlue®) Tank Capacity	gal. (L)	10.4 Gal (39.5)	10.4 Gal (39.5)	10.4 Gal (39.5)	10.4 Gal (39.5)	10.4 Gal (39.5)	10.4 Gal (39.5)
Service Interval	eng. hours	600	600	600	600	600	600
<b>Electrical</b>							
Alternator		150 Amp Std. on all models; 200 Amp optional					
Battery		1300 CCA	1300 CCA	1300 CCA	1300 CCA	1300 CCA	1300 CCA
ISO BUS Class 2 (Optional with Plus and Elite, Standard on AC)		○	○	○	○	○	○
ISO BUS Class 3 (Optional on Auto Command Tractors only)		○	-	○	○	○	-
<b>Transmission</b>							
<b>Electro Command™</b>							
Standard – Semi-Power Shift 16x16	mph (kph)	1.41-25 [2.27-40]***		-	1.41-25 [2.27-40]***		
Option 1 – With Creeper 32x32	mph (kph)	0.12-25 [.19-40]***		-	0.12-25 [.19-40]***		
Option 2 – With AutoShift 16x16	mph (kph)	1.41-25 [2.27-40]***		-	1.41-25 [2.27-40]***		
Option 3 – Economy w/ AutoShift 17x16	mph (kph)	1.67-25 [2.68-40]		-	1.67-25 [2.68-40]		
Option 4 – Fast Mover w/ AutoShift 17x16	mph (kph)	1.67-31 [2.68-50]		-	1.67-31 [2.68-50]		
<b>Dynamic Command™</b>							
Standard – 23 X 23	mph (kph)	1.41-25 [2.27-40]		-	1.41-25 [2.27-40]		
Option 1 – 24 X 24 Economy 40 KPH	mph (kph)	1.41-25 [2.27-40]		-	1.41-25 [2.27-40]		
Option 2 – 24 X 24 50 KPH	mph (kph)	1.67-31 [2.68-50]		-	1.67-31 [2.68-50]		
Option 3 – 24x24 Creeper 40 kph	mph (kph)	0.12-25 [.19-40]		-	0.12-25 [.19-40]		
Option 4 – 24x24 Creeper 40 kph Eco	mph (kph)	0.12-25 [.19-40]		-	0.12-25 [.19-40]		
Option 5 – 24x24 Creeper 50 kph	mph (kph)	0.12-31 [.19-50]		-	0.12-31 [.19-50]		
<b>Auto Command™</b>							
Standard Auto Command CVT	mph (kph)	0.01-25 [.01-40]		-	0.01-25 [.01-40]		
Optional Auto Command CVT	mph (kph)	0.01-31 [.01-50]		-	0.01-25 [.01-40]		
<b>3 Point hitch</b>							
Standard Lift Capacity - 80mm rams with 21.1 gpm fixed pump (Value)	lbs. (kg)	8338 (3782)	8338 (3782)	8338 (3782)	8338 (3782)	8338 (3782)	8338 (3782)
Standard Lift Capacity - 80mm rams with 33.5 gpm CCLS pump (AC)	lbs. (kg)	9214 (4179)	9214 (4179)	9214 (4179)	9214 (4179)	9214 (4179)	9214 (4179)
Optional Lift Capacity - 90mm rams with 29.9/33.5 gpm CCLS pump (Plus, Elite, AC)	lbs. (kg)	11,649 (5284)	11,649 (5284)	11,649 (5284)	11,649 (5284)	11,649 (5284)	11,649 (5284)
<b>Hydraulics</b>							
Fixed Displacement Implement Pump Flow - Value	gpm (l/m)	21.1 (80)	21.1 (80)	21.1 (80)	21.1 (80)	21.1 (80)	21.1 (80)
Steering Pump Flow	gpm (l/m)	12.4 (47)	12.4 (47)	12.4 (47)	12.4 (47)	12.4 (47)	12.4 (47)
CCLS Hydraulic Implement Pump Flow- Plus & Elite	gpm (l/m)	29.9 (113)	29.9 (113)	29.9 (113)	29.9 (113)	29.9 (113)	29.9 (113)
CCLS Hydraulic Implement Pump Flow- Auto Command	gpm (l/m)	33.5 (127)	33.5 (127)	33.5 (127)	33.5 (127)	33.5 (127)	33.5 (127)
Deluxe Rear Remote Options (N/A for Auto Command™)		2 Mechanical Remotes Standard with 3 and 4 remotes Optional					
Electro Hydraulic Rear Remote Options		3 Electro Hydraulic Remotes Standard on AC with 3 & 4 Optional on Elite, 4 on AC					
Mid-Mount Valve Options		2 or 3 Mechanical or 2 or 3 Electronic					

MODELS	T6.145	T6.155	T6.165	T6.160	T6.175	T6.180
--------	--------	--------	--------	--------	--------	--------

Front axles							
Heavy Duty Two Wheel Drive (2WD)		Available on all Electro Command Semi-power shift models					
Front Wheel Drive (FWD) Axle Class		3 & 4					
Option 1		Standard Front Axle					
Option 2		Suspended Front Axle					
Option 3		Supersteer™ Front Axle					
Weight*							
Shipping Weight (Typical Weight, less ballast, Cab FWD):		Subtract 1,234 lbs. (560 kg) if equipped with the optional 2WD					
Minimum	lbs. [kg]	10,560 (4790)	10,560 (4790)	10,560 (4790)	10,979 (4980)	10,604 (4810)	10,979 (4980)
Average	lbs. [kg]	11,376 (5160)	11,376 (5160)	11,376 (5160)	12,831 (5820)	12,555 (5695)	12,831 (5820)
Maximum	lbs. [kg]	12,513 (5676)	12,513 (5676)	12,513 (5676)	15,245 (6915)	15,245 (6915)	15,245 (6915)
Maximum Gross Vehicle Weight	lbs. [kg]	20,944 (9500)	20,944 (9500)	20,944 (9500)	20,944 (9500)	20,944 (9500)	20,944 (9500)

○ Optional – Not available \* Weights are for a variety of specifications, wheels weights and front weights have been excluded.

\*\* Dimensions shown are with 18.4R38 rear tires with matching front tires. \*\*\* Two wheel drive tractor maximum ground speed is 19 MPH (30 KPH).

Biodiesel blend must fully comply with the latest fuel specification EN14214:2009 and operation is in accordance with operator manual guidelines.

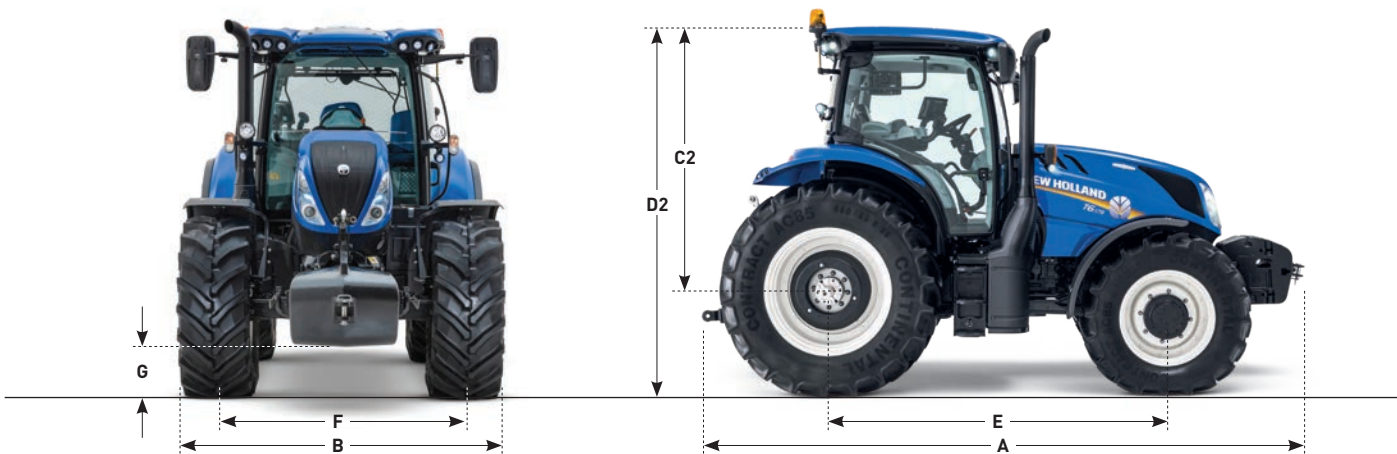

## DIMENSIONS

Dimensions on rear tires <sup>1</sup>		16.9R38	18.4R38	520/70R38	600/65R38	650/65R38 <sup>2</sup>
<b>A</b> Overall length inc. front linkage to rear linkage	in. (mm)	204.3 (5189)	204.3 (5189)	204.3 (5189)	204.3 (5189)	204.3 (5189)
<b>B</b> Minimum width	in. (mm)	89.8 (2280)	89.8 (2280)	89.8 (2280)	89.8 (2280)	91 (2314)
<b>C1</b> Height at center of rear axle to top of low profile cab	in. (mm)	78 (1980)	78 (1980)	78 (1980)	78 (1980)	78 (1980)
<b>C2</b> Height at center of rear axle to top of standard cab	in. (mm)	82.7 (2100)	82.7 (2100)	82.7 (2100)	82.7 (2100)	82.7 (2100)
<b>C2</b> Height at center of rear axle to top of Comfort Ride™ suspension cab	in. (mm)	85.2 (2165)	85.2 (2165)	85.2 (2165)	85.2 (2165)	85.2 (2165)
<b>D1</b> Overall height of low profile cab	in. (mm)	109.5 (2780)	110.4 (2805)	110.4 (2805)	110.4 (2805)	112.4 (2855)
<b>D2</b> Overall height of standard cab	in. (mm)	114.2 (2900)	115.2 (2925)	115.2 (2925)	115.2 (2925)	117.1 (2975)
<b>D2</b> Overall height of Comfort Ride™ suspension cab	in. (mm)	116.7 (2965)	117.7 (2990)	117.7 (2990)	117.7 (2990)	119.7 (3040)
<b>E</b> Wheelbase: Standard 4WD axle	in. (mm)	104 (2642)	104 (2642)	104 (2642)	104 (2642)	104 (2642)
Terraglide™ suspended axle	in. (mm)	105.7 (2684)	105.7 (2684)	105.7 (2684)	105.7 (2684)	105.7 (2684)
SuperSteer™ axle	in. (mm)	109.8 (2788)	109.8 (2788)	109.8 (2788)	109.8 (2788)	109.8 (2788)
<b>F</b> Track width (min. / max.)	in. (mm)	57.5 / 84 (1460 / 2134)	60.2 / 84 (1530 / 2134)	64.3 / 84 (1634 / 2134)	64.3 / 84 (1634 / 2134)	65.5 / 84 (1664 / 2134)
<b>G</b> Ground clearance	in. (mm)	16.8 (427)	18.8 (478)	18.8 (478)	18.8 (478)	20.8 (528)

<sup>1</sup>Rear tire other than those mentioned are available: 480/70R38, 540/65R38, 650/60R38 <sup>2</sup>Only compatible with Comfort Ride™ cab suspension



# VALUE, SERVICE AND SOLUTIONS

There's a certain way of thinking that comes from living on a farm. Farming takes equal parts brain and brawn. Not to mention thick skin, calloused hands and a fair share of know how. Seasoned farmers know it helps to have equipment that's built by farmers, sold by farmers and used by farmers.

**Support at every step.** When you place your confidence in New Holland agricultural equipment, you get the finest in local support. Your New Holland dealer understands the many challenges you face and stands behind you at every step with the equipment, parts, service and financial solutions to make your job easier. Look to New Holland for a complete selection of equipment, including a full line of tractors, hay & forage equipment, harvesting, crop production and material handling equipment.

**Quality parts and service.** Turn to your New Holland dealer after the sale for expert, factory-trained service and genuine New Holland-branded parts. Your dealer has the very latest service updates and training to ensure your equipment keeps working productively season after season.

**Financing solutions.** Your New Holland dealer can tell you about smart ways to turn your financial challenges into opportunities with a portfolio of innovative financial services available through CNH Industrial Capital, including customized financing, leasing, insurance and the purchasing convenience of a Commercial Revolving Account.

For reliable equipment, parts and service — or just honest advice on farming and finance — turn to New Holland and your trusted New Holland dealer. We know. We're farmers, too.



We are proud to support the FFA.

Learn more at [www.newholland.com](http://www.newholland.com)

Design, materials and/or specifications are subject to change without notice and without liability therefor. Specifications are applicable to units sold in Canada, the United States, its territories and possessions, and may vary outside these areas.

© 2021 CNH Industrial America LLC. All rights reserved. New Holland is a trademark registered in the United States and many other countries, owned by or licensed to CNH Industrial N.V., its subsidiaries or affiliates. Any trademarks referred to herein, in association with goods and/or services of companies, other than owned by or licensed to CNH Industrial N.V., its subsidiaries or affiliates, are the property of those respective companies.



Safety begins with a thorough understanding of the equipment. Always make sure you and your operators read the Operator's Manual before using the equipment. Pay close attention to all safety and operating decals and never operate machinery without all shields, protective devices and structures in place.

NH45145464 • 0121 • OTP • PRINTED IN U.S.A.