

# *Inter-Row Tiller* - BREVIGLIERI

ROTOCULTEUR INTER-RANG - BREVIGLIERI

SECTION

# H-3



# Inter-row Cultivation

## Culture inter-rang



[www.walcoequipment.com](http://www.walcoequipment.com)

**HEAD OFFICE**

20 ARTHUR STREET NORTH, ELMIRA, ONTARIO N3B 1Z9

TEL: (519) 669-4025 FAX: (519) 669-1436

e-mail: [orders@walcoequipment.com](mailto:orders@walcoequipment.com)

TEL: (519) 669-1401 FAX (519) 669-3499

**ORDER DESK**

**QUEBEC OFFICE**

364 RTE.122 ST. GERMAIN DE GRANTHAM, QUÉBEC J0C

TEL: (819) 395-5115 Fax (819) 395-2624

e-mail: [walcoqc@walcoequipment.com](mailto:walcoqc@walcoequipment.com)

**WALCO USA**

4469 292<sup>nd</sup> St. E. Box 57 Randolph MN 55065

Tel: (507) 663-9090 Fax (507) 663-0999

## FRAME

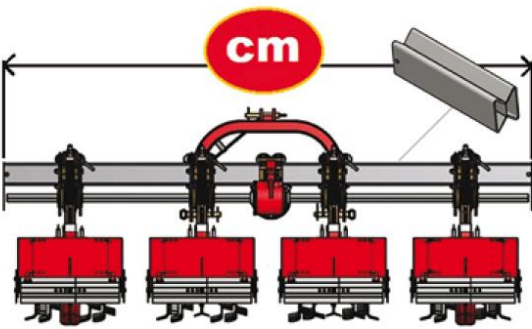

Length of Frame (cm)  
 MBE 3: cm 165 - 230 - 280 - 330 - 440 - 310 P - 452 P  
 MG 4: cm 237 - 282 - 360 - 440  
 MG 4 H: cm 330 - 375 - 455

**MANUAL FOLDING**

**HYDRAULIC FOLDING**

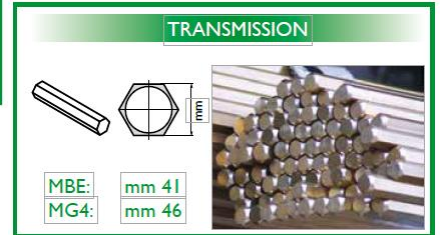

## ELEMENTS

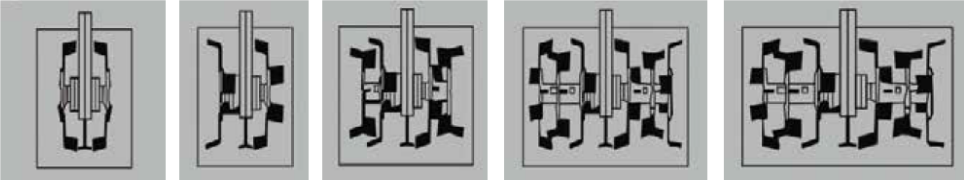

**EXTRA NARROW**  
**NARROW** 25-40 cm  
**MEDIUM** 40-55 cm  
**LARGE** 55-70 cm  
**EXTRA LARGE** 75-90 cm

Note: Elements are adjustable in increments of 5 cm.  
 MBE3 Elements only fit on MBE3 Frames. — MG4 Elements only fit on MG4 Frames

## MBE 3 SEEDER ATTACHMENT NOT INCLUDED MG 4 SEMOIR NON-INCLUS







30 - 80 HP



40 - 90 HP



### MBE 3

	Beans cm. 45-50		Corn cm. 65-70		Sugarbeet cm. 45-50		Sunflower cm. 65-70		Flowers cm. 45-50
	Tomatoes cm. 65-70		Potatoes cm. 65-70		Tobacco cm. 65-70		Cotton cm. 65-70		Strawberry cm. 55-60

### MG 4

	Beans cm. 45-50		Corn cm. 65-70		Sugarbeet cm. 45-50		Sunflower cm. 65-70		Artichoke cm. 75-90
	Tomatoes cm. 75-90		Potatoes cm. 75-80		Tobacco cm. 75-80		Cotton cm. 65-70		

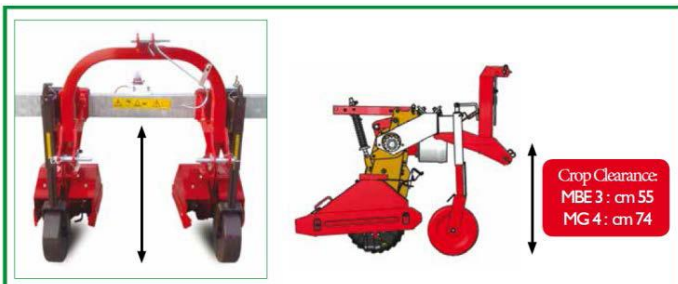

### Optional Accessories (Call for pricing and availability)

